



# VALVES, FITTINGS & TUBING PRESSURE VESSELS & REACTORS

**HiP** High Pressure Equipment  
A GRACO Company



## **HiP... Our Name is High Pressure**

High pressure valves, fittings and tubing manufactured to the highest quality standards, delivered with the shortest lead times, and priced to make you money... it's been the focus at HiP throughout our more than 65 year history. We offer a broad product portfolio capable of handling pressures up to 150,000 psi and carry an extensive inventory allowing us to offer same day shipping of many items. In addition to our high pressure valves, we offer a complete line of reactors and pressure vessels and an expanded family of pumping systems and instrument valves.

In addition to our standard products, we offer a complete line of valves and fittings for oil and gas industry use with sour gas (H<sub>2</sub>S). For applications involving specialty gases, corrosive liquids, and extreme temperatures/conditions, we'll make our products using exotic alloys and temperature extensions, as well as design and build a solution to meet your exact requirements, such as our popular custom manifolds. This dedication to satisfying our loyal customers is the driving force behind our continued growth, including our passing the 4 million high pressure valves and fittings shipped milestone.

## **Commitment to Quality**

As a company that exclusively deals in elevated pressure applications, we understand that our customers depend on our products to provide safe and reliable operation at pressures as high as 150,000 psi. Throughout our history we have been dedicated to continuous improvement in all aspects of our manufacturing operation and customer service. This commitment has only increased over time, including our joining the Graco family of companies and implementing their world class quality systems.

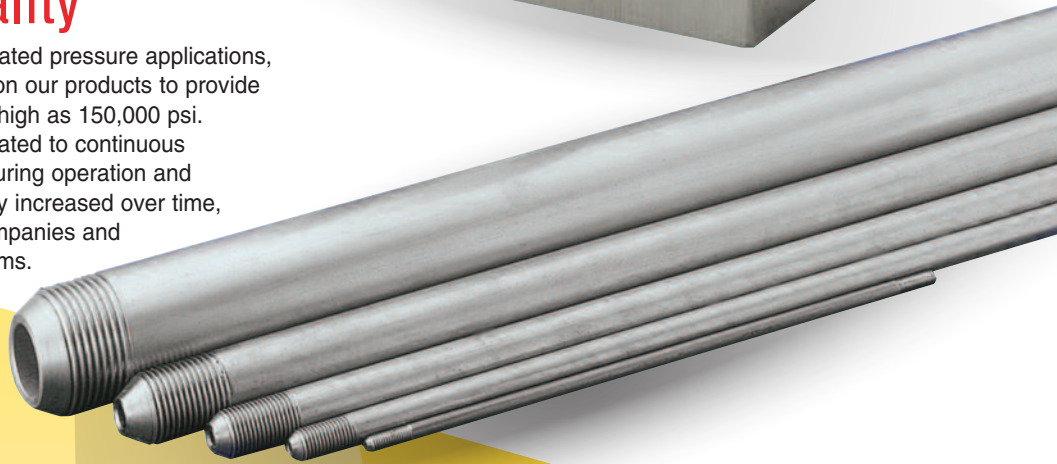
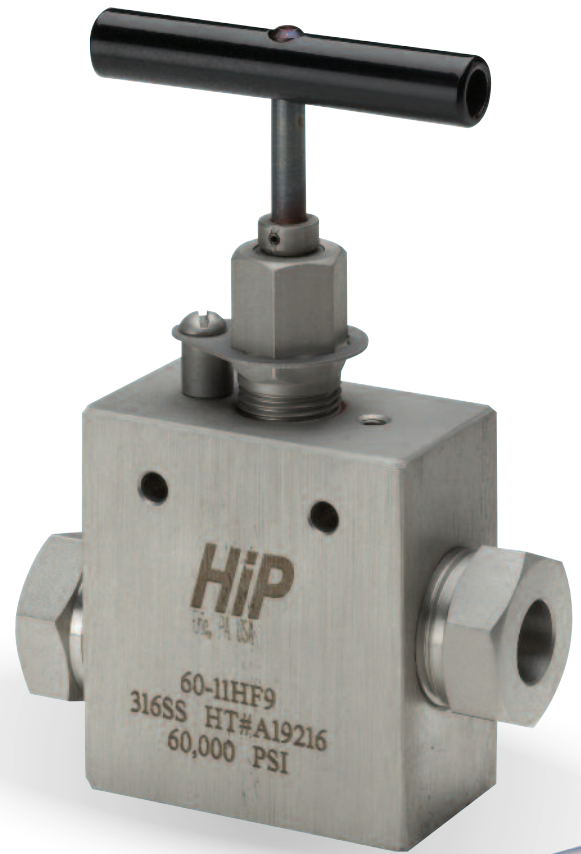

# **Markets**

Our high standards for quality, service and value have enabled us to achieve preferred supplier status with a wide variety of market leaders in many different industries.

- **Waterjet Cutting and Blasting**
- **Oil and Gas**
- **Chemical and Petrochemical**
- **Research and Development**
- **Universities and Government**
- **General Industry**

**ISO 9001**  
CERTIFIED



# Family of Products

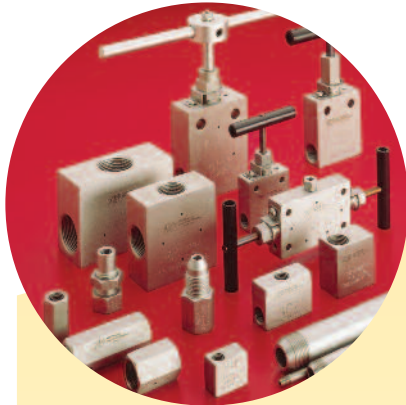

**Low & Medium Pressure Valves**  
10,15 & 20,000 psi



**High & Ultra High Pressure Valves**  
30, 40, 60, 100 & 150,000 psi

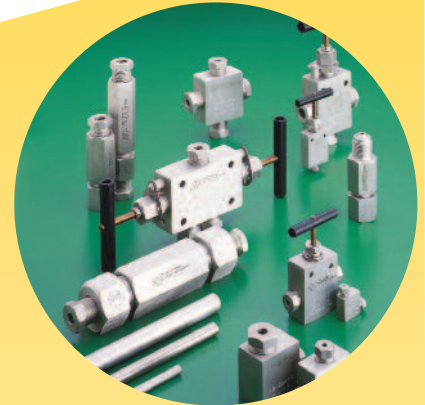

**Fittings & Tubing**  
For All Pressure Classes

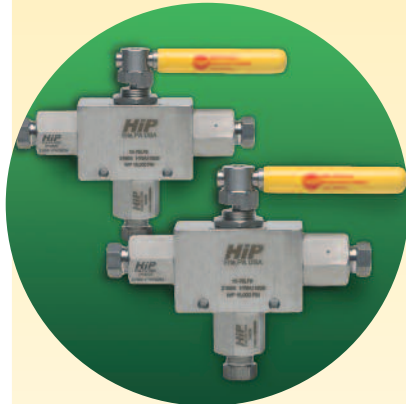

**Ball Valves**  
10,15 & 20,000 psi



**Relief Valves**  
Block & Bleed Valves



**Air Operated Valves**



**Accessories**  
Adapters, Couplings  
& Pressure Gauges



**Oil & Gas Products**  
For Sour Gas Service



**Pressure Vessels  
& Reactors**

# Pumps & Systems

HiP has expanded its line of pumps and systems to become a market leader. In the past several years we have combined our high pressure expertise with the experienced pump engineering team at Graco to develop new products, including T-Series high performance liquid pumps, the eTensifier electric pump system, and e710 supercritical CO<sub>2</sub> extraction pumps. These complement our Sprague air driven pumps, gas boosters and pressure systems, and our family of standard shop pumping systems, portable hydraulic power units, transfer pumps, hydraulic intensifiers and manual pressure generators.



**T-Series**  
High Performance  
Liquid Pumps



**eTensifier**  
Electric Pump  
System



**Sprague**  
Air Driven Pumps  
& Gas Boosters



**e710**  
Supercritical  
CO<sub>2</sub> Extraction Pump



**Packaged Pressure**  
Systems



**Hydraulic Intensifiers**  
& Manual Generators



**Standard Shop**  
Pumping Systems

To learn more about HiP Pumps & Systems, visit [HighPressure.com/Pump](http://HighPressure.com/Pump)

# Table of Contents

<b>Valve Design &amp; Selection</b>	<b>1</b>
<b>Taper Seal Valves, Fittings &amp; Tubing - 10,000 &amp; 15,000 psi service</b>	<b>2</b>
<b>NPT Valves, Fittings &amp; Tubing -10,000 &amp; 15,000 psi service</b>	<b>3</b>
<b>Medium Pressure Valves, Fittings &amp; Tubing - 20,000 psi service</b>	<b>4</b>
<b>High Pressure Valves, Fittings &amp; Tubing - 30,000, 40,000 &amp; 60,000 psi service</b>	<b>5</b>
<b>Ultra High Pressure Valves, Fittings &amp; Tubing - 100,000 &amp; 150,000 psi service</b>	<b>6</b>
<b>Air Operated Valves - piston &amp; diaphragm operators</b>	<b>7</b>
<b>Ball Valves &amp; Subsea Ball Valves - 10,000, 15,000 &amp; 20,000 psi service</b>	<b>8</b>
<b>Relief Valves - metal seat, soft seat &amp; field adjustable</b>	<b>9</b>
<b>Block &amp; Bleed Valves - 20,000 psi service</b>	<b>10</b>
<b>Oil &amp; Gas Products</b>	<b>11</b>
<b>Accessories - adapters &amp; couplings</b>	<b>12</b>
<b>Custom Manifolds</b>	<b>13</b>
<b>Astragauge High Pressure Gauges - 150,000 psi service</b>	<b>14</b>
<b>Tooling</b>	<b>15</b>
<b>Pressure Vessels &amp; Reactors</b>	<b>16</b>
<b>Technical Information</b>	<b>17</b>

# Valve Design

## General

1

- Valve bodies through 100,000 psi are high tensile Type 316 stainless steel, 150,000 psi valve bodies are 17-4 PH stainless steel.
- Stem assemblies have non-rotating tips to prevent galling with valve seats.
- Packing is located below the stem threads to prevent contact with media (liquid or gas).
- Packing glands are equipped with locking devices or lock nuts.
- Six valve patterns (see chart on page 7).
- Tubing connections are:  $\frac{1}{16}$ " ,  $\frac{1}{8}$ " ,  $\frac{1}{4}$ " ,  $\frac{3}{8}$ " ,  $\frac{9}{16}$ " ,  $\frac{3}{4}$ " , 1" and  $1\frac{1}{2}$ ".  
Pipe connections include:  $\frac{1}{8}$ " ,  $\frac{1}{4}$ " ,  $\frac{3}{8}$ " ,  $\frac{1}{2}$ " ,  $\frac{3}{4}$ " , and 1" NPT.
- Remote control air operators are available for most valves.

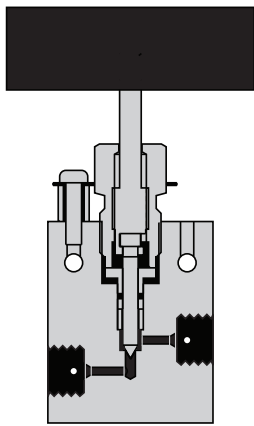

Slotted Stem

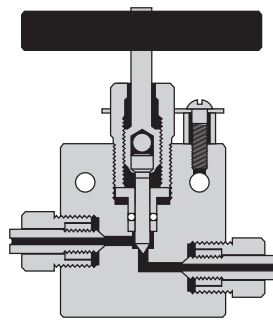

Rolled Style Stem

**Slotted Stem:** Non-rotating slotted stems are standard on AF4, AF6, LF4, LF6, LF9, HF6, HF4, and HF9 (30,000 psi) HF2, HF4, HF6, HF9 (60,000 psi) for on-off service and ensure long life on valve seats. Regulating tip stems are available for all valves at no additional cost, add -REG to part number.

**Rolled Style Stem:** This simple two-piece design is also non-rotating and is ideal for smaller valves and for valves made from exotic materials. The standard lower section stem is manufactured from hardened 17-4 PH stainless steel. It is affixed to a one-piece upper stem requiring no periodic adjustment. The two stem components are free to rotate independently of each other, thereby minimizing rotation of the lower stem against the valve seat.

The Rolled Style Stem is standard for all AF1, AF2, NFA, NFB, LF4, LF6 valves, 30,000 psi HF2, XF4, and XF6 valves, as well as most valves requiring stems made from exotic materials. It is optional for any valve normally supplied with a Positive Guide Stem.

**Pinned Stem Design:** This variation on the Rolled Style Stem is a three-piece design in which the lower stem is pinned into a freely-rotating stem guide. It has all of the advantages of the rolled style stem, with the additional benefit of a replaceable lower section stem.

The Pinned Stem Design is standard for all NFC, NFD, NFF, NFH, LF9, LF12, LF16, and HF16 valves.

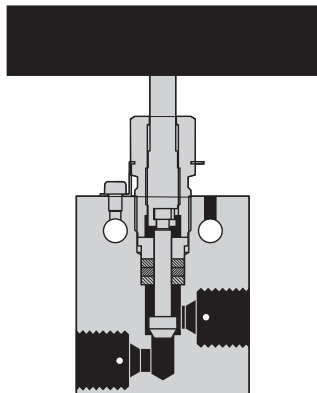

Pinned Stem

# Quick Selector Guide to Standard Valves

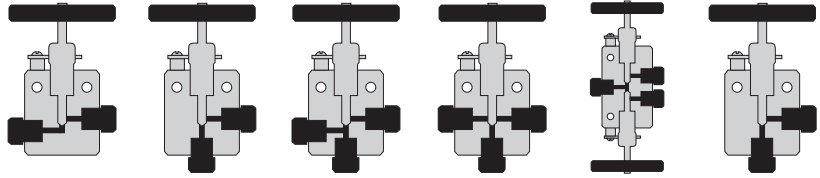

1

## Taper Seal Valves

	Tubing Size		Two Way Straight	Two Way Angle	Three Way Two Press	Three Way One Press	Three Way Two Stem	Replaceable Seat
	O.D.	I.D.						
10,000 psi	1/4"	1/8"	10-11AF4	10-12AF4	10-13AF4	10-14AF4	10-15AF4	10-12AF4-R
	3/8"	1/4"	10-11AF6	10-12AF6	10-13AF6	10-14AF6	10-15AF6	10-12AF6-R
15,000 psi	1/16"	.030"	15-11AF1	15-12AF1	15-13AF1	15-14AF1	15-15AF1	NA
	1/8"	1/16"	15-11AF2	15-12AF2	15-13AF2	15-14AF2	15-15AF2	NA

## NPT Valves

10,000 psi	1/8"		10-11NFA	10-12NFA	10-13NFA	10-14NFA	10-15NFA	10-12NFA-R
	1/4"		10-11NFB	10-12NFB	10-13NFB	10-14NFB	10-15NFB	10-12NFB-R
	3/8"		10-11NFC	10-12NFC	10-13NFC	10-14NFC	10-15NFC	10-12NFC-R
	1/2"		10-11NFD	10-12NFD	10-13NFD	10-14NFD	10-15NFD	10-12NFD-R
	3/4"		10F-11NFF	10F-12NFF	10F-13NFF	10F-14NFF	10F-15NFF	10F-12NFF-R
	1"		10F-11NFH	10F-12NFH	10F-13NFH	10F-14NFH	10F-15NFH	10F-12NFH-R
15,000 psi	1/8"		15F-11NFA	15F-12NFA	15F-13NFA	15F-14NFA	15F-15NFA	15F-12NFA-R
	1/4"		15F-11NFB	15F-12NFB	15F-13NFB	15F-14NFB	15F-15NFB	15F-12NFB-R
	3/8"		15F-11NFC	15F-12NFC	15F-13NFC	15F-14NFC	15F-15NFC	15F-12NFC-R
	1/2"		15F-11NFD	15F-12NFD	15F-13NFD	15F-14NFD	15F-15NFD	15F-12NFD-R

## Medium Pressure Valves

10,000 psi	3/4"	33/64"	10-11LF12	10-12LF12	10-13LF12	10-14LF12	10-15LF12	10-12LF12-R
	1"	11/16"	10-11LF16	10-12LF16	10-13LF16	10-14LF16	10-15LF16	10-12LF16-R
15,000 psi	1 1/2"	15/16"	15-11LF24	15-12LF24	15-13LF24	15-14LF24	15-15LF24	15-12LF24-R
20,000 psi	1/4"	7/64"	20-11LF4	20-12LF4	20-13LF4	20-14LF4	20-15LF4	20-12LF4R
	3/8"	13/64"	20-11LF6	20-12LF6	20-13LF6	20-14LF6	20-15LF6	20-12LF6R
	9/16"	5/16"	20-11LF9	20-12LF9	20-13LF9	20-14LF9	20-15LF9	20-12LF9R
	3/4"	33/64"	20-11LF12	20-12LF12	20-13LF12	20-14LF12	20-15LF12	20-12LF12R
	1"	11/16"	20-11LF16	20-12LF16	20-13LF16	20-14LF16	20-15LF16	20-12LF16R

## High Pressure Valves

30,000 psi	1/8"	.040"	30-11HF2	30-12HF2	30-13HF2	30-14HF2	30-15HF2	30-12HF2R
	1/4"	.083"	30-11HF4	30-12HF4	30-13HF4	30-14HF4	30-15HF4	30-12HF4R
	3/8"	1/8"	30-11HF6	30-12HF6	30-13HF6	30-14HF6	30-15HF6	30-12HF6R
	9/16"	3/16"	30-11HF9	30-12HF9	30-13HF9	30-14HF9	30-15HF9	30-12HF9R
	1"	.437"	30-11HF16	30-12HF16	30-13HF16	30-14HF16	30-15HF16	30-12HF16R
60,000 psi	1/8"	.020"	60-11HF2	60-12HF2	60-13HF2	60-14HF2	60-15HF2	60-12HF2R
	1/4"	1/16"	60-11HF4	60-12HF4	60-13HF4	60-14HF4	60-15HF4	60-12HF4R
	3/8"	1/8"	60-11HF6	60-12HF6	60-13HF6	60-14HF6	60-15HF6	60-12HF6R
	9/16"	3/16"	60-11HF9	60-12HF9	60-13HF9	60-14HF9	60-15HF9	60-12HF9R

## Ultra High Pressure Valves

100,000 psi	1/4"	1/16"	100-11XF4	100-12XF4	100-13XF4	100-14XF4	NA	100-12XF4R
150,000 psi	3/8"	1/16"	150-11XF6	150-12XF6	150-13XF6	150-14XF6	NA	150-12XF6R



# Catalog Numbering System

1

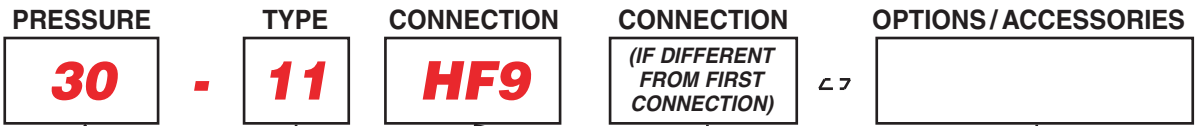

## Pressure Series

10 =	10,000 psi
15 =	15,000 psi
20 =	20,000 psi
30 =	30,000 psi
40 =	40,000 psi
60 =	60,000 psi
100 =	100,000 psi
150 =	150,000 psi

Catalog part numbers for some components (NPT fittings, special alloy parts) have been maintained for historical consideration.

The referred pressure series may not reflect the actual pressure rating. Please refer to applicable catalog page for pressure rating, or consult the factory.

## Type of Components

2 =	Gland, Collar or Sleeve
3 =	Anti-Vibration Assembly
7 =	Plug
11 =	2-Way Straight Valve
12 =	2-Way Angle Valve
13 =	3-Way Valve with Two Pressure Connections
14 =	3-Way Valve with One Pressure Connections
15 =	3-Way, 2-Stem Valve
16 =	Ball Valve (Floating)
21 =	Coupling or Adapter
22 =	Elbow
23 =	Tee
24 =	Cross
41 =	Check Valve
51 =	Line Filter
61 =	Safety Head (Straight)
63 =	Safety Head (Tee Type)
71 =	2-Way Ball Valve *
72 =	3-Way Ball Valve 180° *
73 =	3-Way Ball Valve Diverter *
74 =	2-Way Ball Valve *
75 =	3-Way Ball Valve 180° *
76 =	3-Way Ball Valve Diverter *
77 =	3-Way Mini Ball Valve 1/4" NPT
80 =	2-Way Ball Valve *
81 =	3-Way Ball Valve 180° *
82 =	3-Way Ball Valve Diverter *

\* (Trunion)

## Connection(s) Size and Type

Female	Male	
AF1	AM1	1/16" Taper Seal
AF2	AM2	1/8" Taper Seal
AF4	AM4	1/4" Taper Seal
AF6	AM6	3/8" Taper Seal
LF4	LM4	1/4" Medium Pressure
LF6	LM6	3/8" Medium Pressure
LF9	LM9	9/16" Medium Pressure
LF12	LM12	3/4" Medium Pressure
LF16	LM16	1" Medium Pressure
LF24	LM24	1 1/2" Medium Pressure
HF2	HM2	1/8" High Pressure
HF4	HM4	1/4" High Pressure
HF6	HM6	3/8" High Pressure
HF9	HM9	9/16" High Pressure
HF16	HM16	1" High Pressure
XF4	XM4	1/4" Ultra High Pressure
XF6	XM6	3/8" Ultra High Pressure
NFA	NMA	1/8" NPT Pipe
NFB	NMB	1/4" NPT Pipe
NFC	NMC	3/8" NPT Pipe
NFD	NMD	1/2" NPT Pipe
NFF	NMF	3/4" NPT Pipe
NFH	NMH	1" NPT Pipe
—	HA9	9/16" Hose
—	HA12	3/4" Hose
—	HA16	1" Hose
—	HA21	1 5/16" Hose

## Options

- V = Micro Control Metering Assembly
- HT = High Temperature Stem Extension (Up to 1,000° F)
- SGS = Sour Gas (H<sub>2</sub>S) Service
- N/O = Normally Open
- N/C = Normally Closed
- K = With Antivibration Collars and Glands
- REG = Regulating Tip
- TSR8 = Ball Valve Actuator
- TDA8 = Ball Valve Actuator Double Acting
- W/O = Without Collars and Glands
- LT = Low Temperature Stem Extension (to -320°F)
- MPO-NO = Medium Duty Piston Operator Normally Open
- MPO-NC = Medium Duty Piston Operator Normally Closed
- HPO-NO = Heavy Duty Piston Operator Normally Open
- HPO-NC = Heavy Duty Piston Operator Normally Closed
- EHPO-NO = Extra Heavy Piston Operator Normally Open
- EHPO-NC = Extra Heavy Piston Operator Normally Closed
- OC = Oxygen Cleaning
- HL = Handle Lock (Ball Valve Only)
- MHNO = Mini Hippo Normally Open
- MHNC = Mini Hippo Normally Closed
- LS = Limit Switch

## How to Order Valves and Fittings

Simply indicate catalog number and specify option or special requirement.

### Examples:

30-11HF4 = 30,000 psi Straight Valve for 1/4" O.D. tubing

60-23HF4 = 60,000 psi Tee for 1/4" O.D. tubing

15-21AF2 = 15,000 psi Straight Coupling for 1/8" O.D. tubing, Taper Seal connections

30-11HF6-NT = 30,000 psi Straight Valve for 3/8" O.D. tubing with High Temperature Extension

"HIPCO" 10-12NFB (N/C) = 10,000 psi Angle Valve for 1/4" NPT Pipe with "Hipco" Air Operator, Normally Closed

"HIPPO" 15-11A4F (N/C) = 10,000 psi Angle Valve for 1/4" Taper Seal with "Hippo" Piston Operator, Normally Closed

60-21HF4 (Hastelloy C-276) = 60,000 psi Straight Coupling for 1/4" O.D. tubing, made from Hastelloy C-276 material





# High Pressure Equipment

## Low Pressure Valves, Fittings and Tubing

### Taper Seal -10,000 and 15,000 psi service

High Pressure Equipment Company has developed the Taper Seal line of products to assure safe and easy plumbing through 15,000 psi. These needle valves, fittings, line filters, check valves, safety heads, rupture discs and tubing are engineered and manufactured to the highest standards of repeatable quality. The reliable performance of these products has made HiP one of the world's leading suppliers of elevated pressure components.

Taper Seal components use a compression type tubing connection that requires no special tooling for tubing preparation. Taper Seal valves are available for  $\frac{1}{16}$ ",  $\frac{1}{8}$ ",  $\frac{1}{4}$ ", and  $\frac{3}{8}$ " O.D. tubing and five patterns to satisfy widely varying requirements. A line of fittings is available to facilitate adapting to NPT, Medium or High Pressure pipe systems.

2



### Index

Valves .....	10-11
Fittings .....	12
Bulkhead Couplings & Caps .....	13
Line Filters & Check Valves .....	14
Safety Heads .....	15
Rupture Discs .....	16
Tubing .....	16
Connection Details .....	17
Assembly Procedure .....	18

# Taper Seal Needle Valves

## 10,000 and 15,000 psi service

**Compression type tubing connections** for  $\frac{1}{16}$ " ,  $\frac{1}{8}$ " ,  $\frac{1}{4}$ " , and  $\frac{3}{8}$ " O.D. tubing. Requires no special tooling for tubing preparation (simply cut off, deburr, and insert tubing into connection). Connection details are shown on page 17.

2

**Non-rotating slotted stems** are standard on AF4 and AF6 for on-off service and ensure long life on valve seats. Regulating tip stems are available at no additional cost, add - REG to the catalog number.

**Glands and sleeves** are supplied with each valve unless otherwise requested (glands and sleeves shown on pages 12 and 17).

**Materials** include high tensile type 316 stainless steel for the valve body and hardened 17-4PH stainless steel lower section stem.

**Packing** is Teflon (450°F) standard, with optional Viton (350°F), BUNA-N (200°F) or Grafoil (650°F) available at no additional cost.

**Air operators** for remote control operation are available for all valves. (Refer to Air Operator section of catalog for additional data).



### Valve Features

- Non-rotating slotted stem design (standard for AF4 and AF6)
- Packing below stem threads
- Type 316 ss high tensile bodies
- Positive gland lock device
- No stem adjustment needed
- Black T-handles or choice of 4 colors
- Tube sizes  $\frac{1}{16}$ " through  $\frac{3}{8}$ "

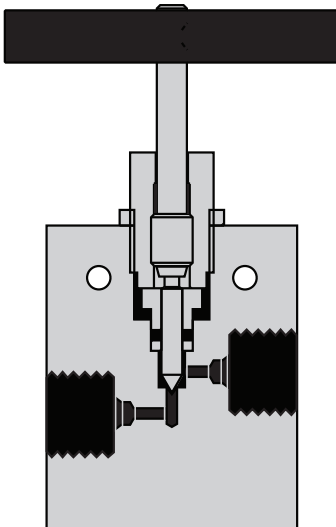

AF1 ( $\frac{1}{16}$ " ) and AF2 ( $\frac{1}{8}$ " )  
15,000 psi

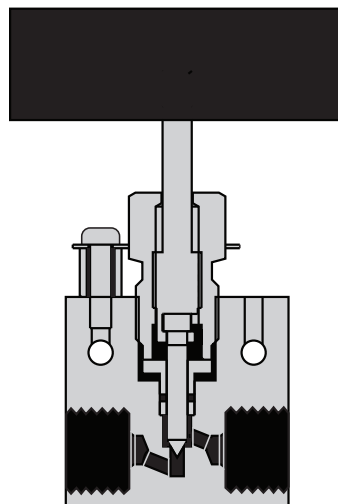

AF4 ( $\frac{1}{4}$ " ) and AF6 ( $\frac{3}{8}$ " )  
10,000 psi

### Two Way Straight Valves

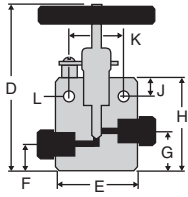

Tubing	Catalog No.	psi	Conn.	Orifice	Cv	D	E	F	G	H	J	K	L	Thickness
1/16" O.D.	15-11AF1	15,000	AF1	0.052"	0.03	2 1/2"	1 1/8"	1/4"	13/32"	1 1/8"	5/16"	3/4"	9/64"	1/2"
1/8" O.D.	15-11AF2	15,000	AF2	1/16"	0.05	3 1/8"	1 1/2"	1 1/16"	15/16"	1 13/16"	5/16"	7/8"	9/64"	3/4"
1/4" O.D.	10-11AF4	10,000	AF4	1/8"	0.15	4 5/8"	2"	1/2"	1 1/2"	1 7/8"	1/2"	1 3/8"	7/32"	1"
3/8" O.D.	10-11AF6	10,000	AF6	1/8"	0.15	4 5/8"	2"	1/2"	1 1/2"	1 7/8"	1/2"	1 3/8"	7/32"	1"

### Two Way Angle Valves

2

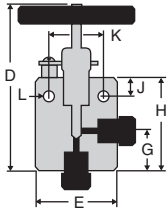

Tubing	Catalog No.	psi	Conn.	Orifice	Cv	D	E	F	G	H	J	K	L	Thickness
1/16" O.D.	15-12AF1	15,000	AF1	0.052"	0.045	2 3/8"	1 1/8"	—	2 1/32"	1 3/8"	5/16"	3/4"	9/64"	1/2"
1/8" O.D.	15-12AF2	15,000	AF2	1/16"	0.075	3 1/8"	1 1/2"	—	15/16"	1 13/16"	5/16"	7/8"	9/64"	3/4"
1/4" O.D.	10-12AF4	10,000	AF4	1/8"	0.225	5 3/16"	2"	—	1 1/16"	2 7/16"	1/2"	1 3/8"	7/32"	1"
3/8" O.D.	10-12AF6	10,000	AF6	1/8"	0.225	5 3/16"	2"	—	1 1/16"	2 7/16"	1/2"	1 3/8"	7/32"	1"

### Three Way Valves / Two Pressure Connections

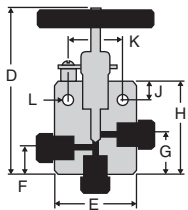

Tubing	Catalog No.	psi	Connection	Orifice	D	E	F	G	H	J	K	L	Thickness
1/16" O.D.	15-13AF1	15,000	AF1	0.052"	2 3/4"	1 1/8"	1/2"	2 1/32"	1 3/8"	5/16"	3/4"	9/64"	1/2"
1/8" O.D.	15-13AF2	15,000	AF2	1/16"	3 1/8"	1 1/2"	1 1/16"	15/16"	1 13/16"	5/16"	7/8"	9/64"	3/4"
1/4" O.D.	10-13AF4	10,000	AF4	1/8"	5 3/16"	2"	1/2"	1 1/16"	2 7/16"	1/2"	1 3/8"	7/32"	1"
3/8" O.D.	10-13AF6	10,000	AF6	1/8"	5 3/16"	2"	1/2"	1 1/16"	2 7/16"	1/2"	1 3/8"	7/32"	1"

### Three Way Valves / One Pressure Connection

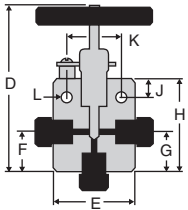

Tubing	Catalog No.	psi	Connection	Orifice	D	E	F	G	H	J	K	L	Thickness
1/16" O.D.	15-14AF1	15,000	AF1	0.052"	2 3/4"	1 1/8"	2 1/32"	2 1/32"	1 3/8"	5/16"	3/4"	9/64"	1/2"
1/8" O.D.	15-14AF2	15,000	AF2	1/16"	3 1/8"	1 1/2"	15/16"	15/16"	1 13/16"	5/16"	7/8"	9/64"	3/4"
1/4" O.D.	10-14AF4	10,000	AF4	1/8"	5 3/16"	2"	1 1/16"	1 1/16"	2 7/16"	1/2"	1 3/8"	7/32"	1"
3/8" O.D.	10-14AF6	10,000	AF6	1/8"	5 3/16"	2"	1 1/16"	1 1/16"	2 7/16"	1/2"	1 3/8"	7/32"	1"

### Three Way / Two Stem Connection Valves

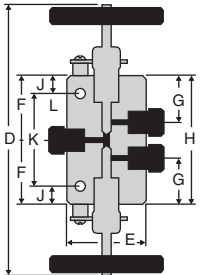

Tubing	Catalog No.	psi	Connection	Orifice	D	E	F	G	H	J	K	L	Thickness
1/16" O.D.	15-15AF1	15,000	AF1	0.052"	4 3/4"	1 1/8"	1"	23/32"	2"	5/16"	1 3/8"	9/64"	1/2"
1/8" O.D.	15-15AF2	15,000	AF2	1/16"	5"	1 1/2"	1 1/4"	7/8"	2 1/2"	5/16"	1 7/8"	9/64"	3/4"
1/4" O.D.	10-15AF4	10,000	AF4	1/8"	8 7/8"	2"	1 11/16"	1 3/16"	3 3/8"	1/2"	2 3/8"	7/32"	1"
3/8" O.D.	10-15AF6	10,000	AF6	1/8"	8 7/8"	2"	1 11/16"	1 3/16"	3 3/8"	1/2"	2 3/8"	7/32"	1"

### Replaceable Seat Valve

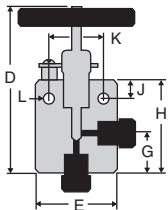

Tubing	Catalog No.	psi	Connection	Orifice	D	E	F	G	H	J	K	L	Thickness
1/4" O.D.	10-12AF4-R	10,000	AF4	1/8"	6 1/8"	2"	—	1 3/8"	2 7/16"	1/2"	1 7/8"	7/32"	1"
3/8" O.D.	10-12AF6-R	10,000	AF6	1/8"	6 1/8"	2"	—	1 1/8"	2 7/16"	1/2"	1 7/8"	7/32"	1"

# Taper Seal Valves

## Glands/Sleeves/Plugs/Elbows/Tees/Crosses

A complete range of elbows, tees, and crosses is available for all of the tubing connection sizes. Material is high tensile 316 stainless steel. Standard tubing glands and sleeves are furnished unless otherwise specified.

2

### Connection Components

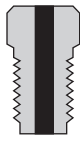
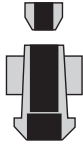
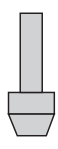
Catalog No.	Tube Size	Gland	Catalog No.	Tube Size	Sleeve	Catalog No.	Tube Size	Plug
15-2AM1	1/16"		15-2A1	1/16"		15-7AM1	1/16"	
15-2AM2	1/8"		15-2A2	1/8"		15-7AM2	1/8"	
10-2AM4	1/4"		10-2A4	1/4"		10-7AM4	1/4"	
10-2AM6	3/8"		10-2A6	3/8"		10-7AM6	3/8"	

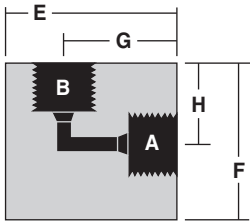

### Taper Seal Elbows

Catalog No.	Pressure Rating psi	Connections	A-B	E	F	G	H	Thickness
15-22AF1	15,000	1/16" O.D. TUBE	AF1	3/4"	3/4"	9/16"	9/16"	3/8"
15-22AF2	15,000	1/8" O.D. TUBE	AF2	1 1/8"	1 1/8"	3/4"	3/4"	3/4"
10-22AF4	10,000	1/4" O.D. TUBE	AF4	1 1/2"	1 1/2"	1"	1"	1"
10-22AF6	10,000	3/8" O.D. TUBE	AF6	1 1/2"	1 1/2"	1"	1"	1"

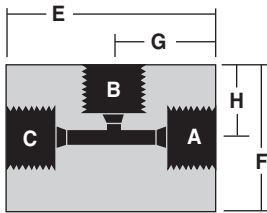

### Taper Seal Tees

Catalog No.	Pressure Rating psi	Connections	A-B-C	E	F	G	H	Thickness
15-23AF1	15,000	1/16" O.D. TUBE	AF1	1"	3/4"	1/2"	9/16"	3/8"
15-23AF2	15,000	1/8" O.D. TUBE	AF2	1 1/2"	1 1/8"	3/4"	3/4"	3/4"
10-23AF4	10,000	1/4" O.D. TUBE	AF4	2"	1 1/2"	1"	1"	1"
10-23AF6	10,000	3/8" O.D. TUBE	AF6	2"	1 1/2"	1"	1"	1"

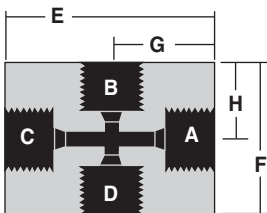

### Taper Seal Crosses

Catalog No.	Pressure Rating psi	Connections	A-B-C-D	E	F	G	H	Thickness
15-24AF1	15,000	1/16" O.D. TUBE	AF1	1"	1"	1/2"	1/2"	3/8"
15-24AF2	15,000	1/8" O.D. TUBE	AF2	1 1/2"	1 1/2"	3/4"	3/4"	3/4"
10-24AF4	10,000	1/4" O.D. TUBE	AF4	2"	2"	1"	1"	1"
10-24AF6	10,000	3/8" O.D. TUBE	AF6	2"	2"	1"	1"	1"



## Bulkhead Couplings

Bulkhead couplings are designed specifically for passing a tubing connection through a panel or steel barricade. These couplings include a locknut as shown. Material is high tensile 316 stainless steel. Standard tubing collars and glands are included unless otherwise specified.

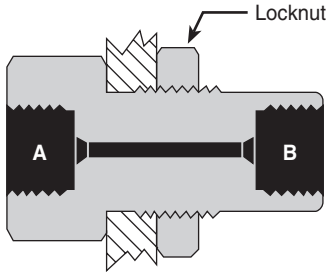

Catalog No.	Tubing	psi	Connections	Orifice	Length	Hex	Hole Diameter	Max. Panel Thickness
15-21AF1-B	1/16"	15,000	AF1	0.052"	1 1/8"	3/4"	9/16"	5/16"
15-21AF2-B	1/8"	15,000	AF2	5/64"	1 3/8"	1"	13/16"	3/8"
10-21AF4-B	1/4"	10,000	AF4	1/8"	2 1/8"	1 3/8"	1 1/8"	5/8"
10-21AF6-B	3/8"	10,000	AF6	1/4"	2 1/8"	1 3/8"	1 1/8"	5/8"

## Caps

Tubing end caps are offered for use in sealing off tubing ends either for temporary use or permanent use, such as on small volume reservoirs. Standard material is high tensile 316 stainless steel. Standard tubing collars and glands are provided unless otherwise specified.

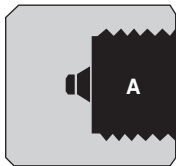

Catalog No.	Tubing	psi	A	Length	Hex
15-21AF1-C	1/16"	15,000	AF1	0.052"	1 1/8"
15-21AF2-C	1/8"	15,000	AF2	5/64"	1 3/8"
10-21AF4-C	1/4"	10,000	AF4	1/8"	2 1/8"
10-21AF6-C	3/8"	10,000	AF6	1/4"	2 1/8"

# Taper Seal Valves

## Line Filters

The line filters as shown utilize sintered stainless steel filter discs (AF2 & AF1 – 3 pc./set, AF4 & AF6 – 4 pc./set). Porosities are available as per the chart to the right. If not otherwise specified, 100 micron filter discs are supplied. (One micron = 0.001 millimeters). Material of bodies and end covers is high tensile 316 stainless steel. Standard glands and sleeves are provided unless otherwise specified.

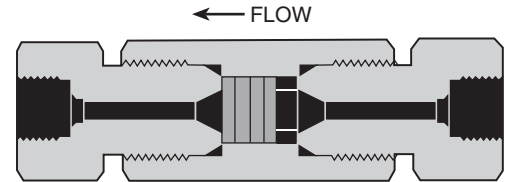

Catalog No.	Pressure Rating psi	Connections	Length	Hex Size	Micron Size Filter Available					
					0.5	2	5	10	40	100
15-51AF1	15,000	1/16" TAPER SEAL	3 1/8"	3/4"	●	●	●	●	●	●
15-51AF2	15,000	1/8" TAPER SEAL	3 1/8"	3/4"	●	●	●	●	●	●
10-51AF4	10,000	1/4" TAPER SEAL	5 1/4"	1 3/8"	●	●	●	●	●	●
10-51AF6	10,000	3/8" TAPER SEAL	5 1/4"	1 3/8"	●	●	●	●	●	●

## Ball Check Valves

Ball type check valves insure flow in one direction only. Material for bodies, balls, and covers is high tensile 316 stainless steel. Standard tubing glands and sleeves are provided unless otherwise specified.

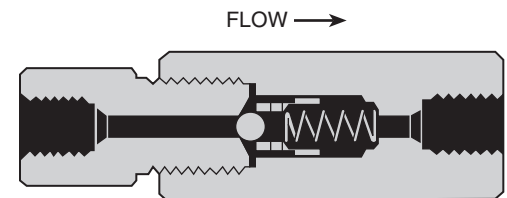

Catalog No.	psi	Connections	Length	Hex
15-41AF1	15,000	1/16" TAPER SEAL	3 1/8"	1"
15-41AF2	15,000	1/8" TAPER SEAL	3 9/16"	1"
10-41AF4	10,000	1/4" TAPER SEAL	3 7/8"	1"
10-41AF6	10,000	3/8" TAPER SEAL	3 7/8"	1"

## Soft Seat Check Valves

Soft seat check valves insure flow in one direction only and can be mounted in any position. These are highly reliable for both gas and liquid service. Standard O-ring (soft seat) material for the sealing surface is Buna-N (nitrile) with other materials including Teflon and Viton available on request. Temperature is limited by the choice of O-ring material. Material of all other parts is high tensile 316 stainless steel. Standard glands and sleeves are provided unless otherwise specified.

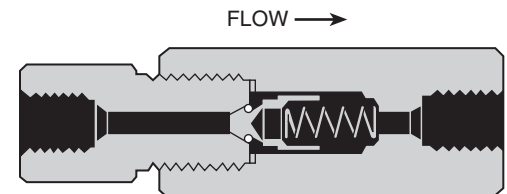

Catalog No.	psi	Connections	Length	Hex
15-41AF1-T	15,000	1/16" TAPER SEAL	3 1/2"	1"
15-41AF2-T	15,000	1/8" TAPER SEAL	3 1/2"	1"
10-41AF4-T	10,000	1/4" TAPER SEAL	3 7/8"	1"
10-41AF6-T	10,000	3/8" TAPER SEAL	3 7/8"	1"

## Safety Heads

A choice of three safety head designs is available: male inlet, female inlet (straight), and tee type. The male inlet design can be inserted directly into the tubing connections of valves and various fittings such as tees and crosses, or located in pressure vessels.

Outlet connections on all sizes are  $\frac{3}{8}$ " pipe (NPT). This outlet may be connected to a suitable discharge line to vent pressure to a safe location in the event of bursting of the rupture disc. Torque required for sealing rupture discs will range from 40 to 60 foot pounds, depending upon pressure and media being used.

Material of bodies and hold down nuts is high tensile 316 stainless steel. Hold down rings are hardened 17-4PH stainless steel. Standard tubing glands and collars (sleeves) are provided unless otherwise specified.

**Note:** Rupture discs are **not** included and must be ordered as a separate item.

**CE marked safety heads are now available, add -CE to end of standard part number. Consult factory for pricing.**

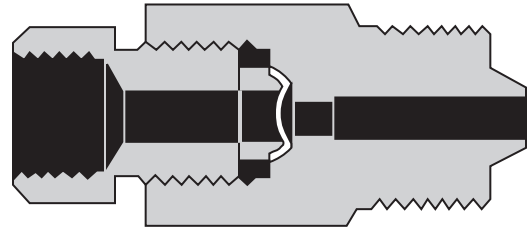

**2**

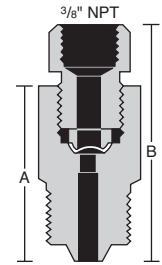

### Male Inlet Safety Heads

Catalog No.	Pressure Rating psi	Inlet Connection	A	B	Hex Size
15-61AM2	15,000	$\frac{1}{8}$ " TAPER SEAL	$1\frac{7}{8}$ "	$2\frac{15}{16}$ "	1"
10-61AM4	10,000	$\frac{1}{4}$ " TAPER SEAL	$2\frac{1}{2}$ "	$2\frac{7}{16}$ "	1"
10-61AM6	10,000	$\frac{3}{8}$ " TAPER SEAL	$2\frac{1}{2}$ "	$2\frac{7}{16}$ "	1"

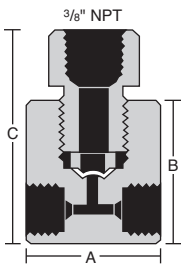

### Tee Type Safety Heads

Catalog No.	Pressure Rating psi	Inlet Connection	A	B	C
15-63AF1	15,000	$\frac{1}{16}$ " TAPER SEAL	$1\frac{1}{8}$ " HEX	$1\frac{3}{4}$ "	$2\frac{3}{4}$ "
15-63AF2	15,000	$\frac{1}{8}$ " TAPER SEAL	$1\frac{1}{2}$ "	$1\frac{1}{2}$ "	$2\frac{1}{2}$ "
10-63AF4	10,000	$\frac{1}{4}$ " TAPER SEAL	2"	$1\frac{3}{4}$ "	$2\frac{7}{8}$ "
10-63AF6	10,000	$\frac{3}{8}$ " TAPER SEAL	2"	$1\frac{3}{4}$ "	$2\frac{7}{8}$ "

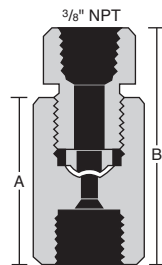

### Female Inlet (Straight) Safety Heads

Catalog No.	Pressure Rating psi	Inlet Connection	A	B	Hex Size
15-61AF1	15,000	$\frac{1}{16}$ " TAPER SEAL	$1\frac{7}{8}$ "	$2\frac{15}{16}$ "	1"
15-61AF2	15,000	$\frac{1}{8}$ " TAPER SEAL	$1\frac{7}{8}$ "	$2\frac{15}{16}$ "	1"
10-61AF4	10,000	$\frac{1}{4}$ " TAPER SEAL	$1\frac{7}{8}$ "	$2\frac{15}{16}$ "	1"
10-61AF6	10,000	$\frac{3}{8}$ " TAPER SEAL	$1\frac{7}{8}$ "	$2\frac{15}{16}$ "	1"

# Taper Seal Valves

## Rupture Discs

### 1/4" Angled Seat

2

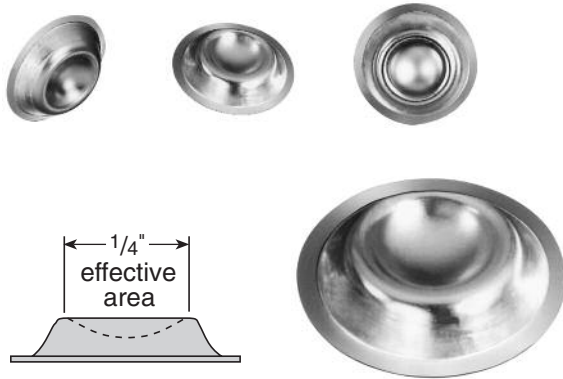

Standard rupture discs are available from stock in burst pressures as listed in the chart below. Taper seal pressures are shaded. These discs are 316 stainless steel (except for 1000 psi which are inconel) and may be used with any of the safety heads shown. Note that these rupture discs are supplied with a range of plus 6% and minus 3% of specified burst pressure. Samples of each batch are then tested and typically the actual average burst pressure is stamped on an accompanying metal tag. There is a +/- 5% burst tolerance applied after the burst pressure has been established. Factors influencing rupture disc life include corrosion, metal fatigue, and cyclic effects. Periodic replacement is recommended to prevent premature failure.

**SPECIAL DISCS** are available on special order for pressure ranges not shown below and in numerous materials and coatings. Consult factory for price and delivery.

### Standard Burst Pressures (in psi at 72°F)

1,000	3,000	5,000	7,000	9,000	11,000	17,500	25,000	37,500	55,000
1,500	3,500	5,500	7,500	9,500	11,500	18,000	27,000	40,000	60,000
2,000	4,000	6,000	8,000	10,000	12,500	20,000	30,000	45,000	65,000
2,500	4,500	6,500	8,500	10,500	15,000	22,500	35,000	50,000	

## Taper Seal Tubing

Tubing is cold drawn, seamless, and is supplied in the 1/8 hard condition (not annealed). Tensile strength is approximately 40 percent higher than that of annealed tubing. All tubing is manufactured in strict accordance with High Pressure Equipment Company specifications to insure tolerances and bore quality. Tubing is stocked in lengths of 20 to 24 feet but may be ordered in shorter lengths with **no additional cutting charge**.

**Note:** The 1/16" and 1/8" O.D. tubing sizes may be coiled for shipment. Larger sizes must be shipped in straight lengths.

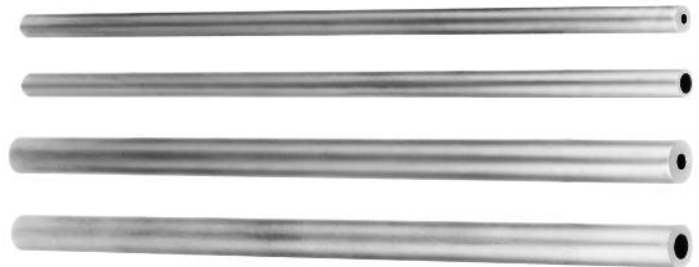

	Tubing Size	Working Pressure psi	Type of Connection Used	Material	Wall Thickness	Catalog Order Number
1/16"	1/16" O.D. x 0.006" I.D.	15,000	1/16" TAPER SEAL (AF1)	316 SS	.028	15-9A1-006
	1/16" O.D. x 0.030" I.D.				.016	15-9A1-030
1/8"	1/8" O.D. x 0.060" I.D.	15,000	1/8" TAPER SEAL (AF2)	316 SS	.032	15-9A2
				Hastelloy-C	.032	15-9A2-HC276
1/4"	1/4" O.D. x 1/8" I.D.	10,000	1/4" TAPER SEAL (AF4)	316 SS	.062	10-9A4-316
				304 SS	.062	10-9A4-304
3/8"	3/8" O.D. x 1/4" I.D.	10,000	3/8" TAPER SEAL (AF6)	316 SS	.062	10-9A6-316



## Taper Seal Connections 10,000 and 15,000 psi service

Taper Seal connections are available for  $\frac{1}{16}$ ",  $\frac{1}{8}$ ",  $\frac{1}{4}$ ", and  $\frac{3}{8}$ " O.D. tubing. No special tubing preparation is required – simply cut tubing to desired length, deburr and assemble.

The  $\frac{1}{8}$ ",  $\frac{1}{4}$ ", and  $\frac{3}{8}$ " sizes utilize a two-piece sleeve which is supplied partially assembled. When the connection is assembled, the outer sleeve portion is permanently compressed over the inner portion to rigidly lock the sleeve onto the tubing. Note that the sleeve is not forced to bite into the tubing, but rather is clamped onto the tubing much like a machine collet.

### Pressure ratings.

The  $\frac{1}{16}$ " and  $\frac{1}{8}$ " O.D. tubing size connections are rated to 15,000 psi working pressure. The  $\frac{1}{4}$ " and  $\frac{3}{8}$ " O.D. sizes are rated to 10,000 psi working pressure.

### Easy make-up connections.

One of the popular benefits of taper seal connections is that it is very easy to determine when the connection is "tight enough" during initial assembly. Simply rotate the tubing gland into the connection until you feel a "bottoming out" or "dead stop" of the wrench. This signals that the connection has been properly made.

A commercial thread lubricant is highly recommended to facilitate initial makeup of the connection, but such lubrication may be removed afterwards if desired. The Taper Seal connection can be disassembled and then reassembled an indefinite number of times.

**Standard material** for the gland is Type 316 stainless steel. The inner portion of the two-piece sleeve is Type 316 stainless steel. The non-wetted outer sleeve portion is zinc plated alloy steel. (Note that the  $\frac{1}{16}$ " O.D. size is a one-piece sleeve design) in Type 316 stainless steel.

**Tubing glands and sleeves** are provided with all valves and fittings unless otherwise requested. (See chart at right for size details and catalog numbers).

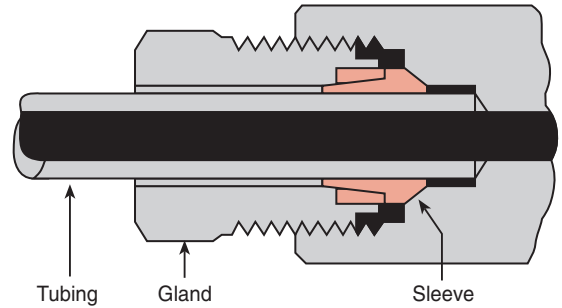

2

	15,000 psi		10,000 psi	
	<b>AF1</b> 1/16" O.D. Tubing	<b>AF2</b> 1/8" O.D. Tubing	<b>AF4</b> 1/4" O.D. Tubing	<b>AF6</b> 3/8" O.D. Tubing
<b>Female Opening Detail</b>				
<b>Gland</b>				
<b>Sleeve</b>				
<b>Plug</b>				

# Taper Seal Valves

## Taper Seal Assembly Procedure – AF2, AF4 and AF6 Connections

2

1. Lubricate the male threads of the Taperseal gland, and the back of the outer collar on the sleeve with a process compatible lubricant.
2. Put a small amount of lubricant on the area where the outer collar and inner sleeve come in contact with each other. This will reduce the friction when the outer collar slides over the inner sleeve.
3. Assemble the Taperseal gland, sleeve and tubing into the component or assembly mandrel and tighten finger-tight.
4. Using the appropriate size wrench, rotate the gland nut clockwise one half turn and stop. Back off the gland nut and repeat this step approximately 3 – 4 times until the gland stops rotating or “bottoms out”. Do not rotate the gland nut continuously clockwise or galling between the outer collar and inner sleeve may occur.
5. Remove the tube with the gland and sleeve attached, and inspect the sleeve assembly to be sure the outer collar has slid completely down over the inner sleeve. No gaps should be present.
6. Refer to page 142 of the Technical Information Section of our catalog for Recommended Torque / Tubing Connections. Torque the tubing gland to the value listed on the chart.
7. Refer to the catalog page 17 for proper connection diagram and component details.
  - Please note that a mandrel can be used to properly make-up the connection rather than using the actual component. Using the mandrel will prevent any galling of the female component threads. Mandrels can be purchased from HiP.



Correctly Assembled Taper Seal Connection



Incorrect Assembly

## Packing Options

### Taper Seal

Material	Part Number		
	AF1	AF2	AF4/ AF6
Teflon*	B-195	B-195	B-181
Grafoil	B-1379	B-1379	B-1417
Buna-N	B-101	B-101	B-102
Viton	B-614	B-614	B-849
Silicone	B-149	B-149	B-147



# High Pressure Equipment

## **NPT Valves, Fittings and Tubing** **10,000 and 15,000 psi service**

High Pressure Equipment Company has developed line of NPT valves and fittings designed to assure safe and easy plumbing through 15,000 psi. These pipe connection valves, fittings, line filters, check valves, safety heads and rupture discs, tubing and nipples are engineered to the highest standards of repeatable quality. The reliable performance of these products has made HiP one of the world's leading suppliers of elevated pressure components.

NPT valves are available in both two-way straight and two-way angle body configurations, and for sizes including 1/8", 1/4", 3/8", 1/2", 3/4" and 1" pipe connections. A line of fittings is available to facilitate adapting to Taper Seal, Medium or High Pressure pipe systems.

**3**

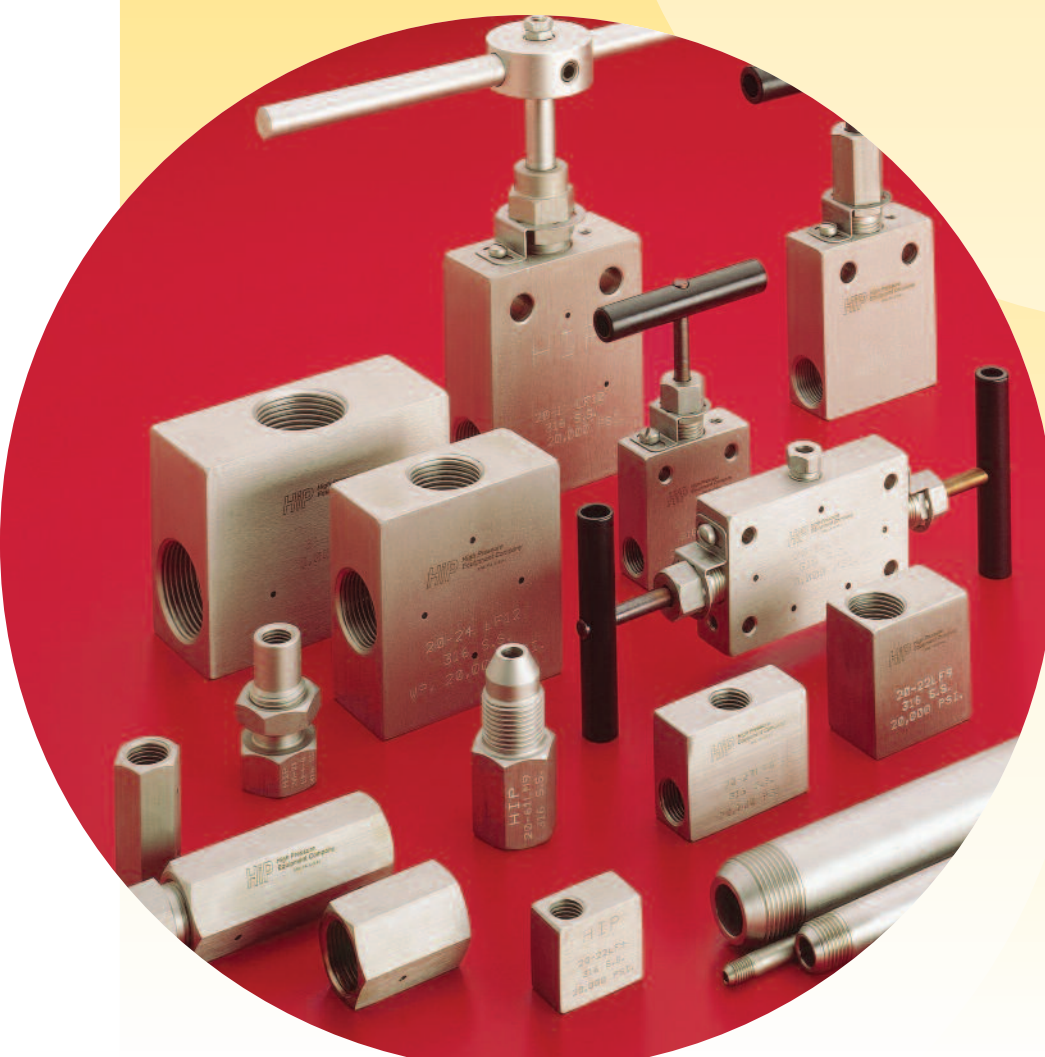

### **Index**

Valves .....	20-21
Valve Options .....	22
Fittings .....	23
Couplings, Bulkheads & Caps .....	24
Line Filters & Check Valves .....	25
Safety Heads .....	26
Rupture Discs .....	27

# NPT Valves

## Pipe Connection Valves

### Female NPT/10,000 psi

#### 1/8" • 1/4" • 3/8" • 1/2" NPT

**Non-rotating slotted stems** are standard for on-off service and insure long life on valve seats. Regulating tip stems are available for all valves at no additional cost.

**Materials** include high tensile Type 316 stainless steel for valve bodies, and hardened 17-4PH stainless steel for lower section stems.

**Packing** is Teflon (450°F) standard with optional Viton (350°F), BUNA-N (200°F) and Grafoil (650°F) available at no additional cost.

**Air operators** for remote control operation are available for all valves. (See Air Operator section of catalog).

**Extreme temperatures** can be accommodated by using extended stuffing boxes (See Valve Options, page 22).



3

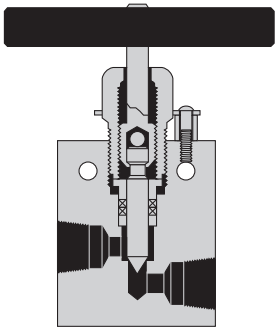

NFD (1/2")

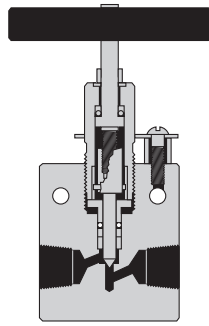

NFA (1/8"), NFB (1/4") and NFC (3/8")

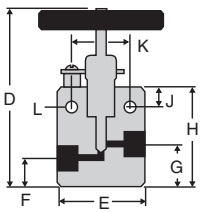

## Two Way Straight Valves

Pipe Size	Catalog No.*	psi	Conn.	Orifice	Cv	D	E	F	G	H	J	K	L	Thickness
1/8" NPT	10-11NFA	10,000	NFA	1/8"	0.15	4 3/4"	2"	7/8"	7/8"	2 7/16"	1/2"	1 3/8"	7/32"	1"
1/4" NPT	10-11NFB	10,000	NFB	1/8"	0.15	4 3/4"	2"	7/8"	7/8"	2 7/16"	1/2"	1 3/8"	7/32"	1"
3/8" NPT	10-11NFC	10,000	NFC	1/8"	0.15	4 3/4"	2"	7/8"	7/8"	2 7/16"	1/2"	1 3/8"	7/32"	1"
1/2" NPT	10-11NFD	10,000	NFD	5/16"	1.12	5 5/8"	2 5/8"	3/4"	1 3/8"	3 1/8"	1/2"	1 5/8"	5/16"	1 1/2"

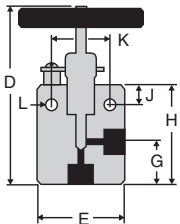

## Two Way Angle Valves

Pipe Size	Catalog No.*	psi	Conn.	Orifice	Cv	D	E	F	G	H	J	K	L	Thickness
1/8" NPT	10-12NFA	10,000	NFA	1/8"	0.225	4 3/4"	2"	—	1"	2 7/16"	1/2"	1 3/8"	7/32"	1"
1/4" NPT	10-12NFB	10,000	NFB	1/8"	0.225	4 3/4"	2"	—	1"	2 7/16"	1/2"	1 3/8"	7/32"	1"
3/8" NPT	10-12NFC	10,000	NFC	1/8"	0.225	4 3/4"	2"	—	1"	2 7/16"	1/2"	1 3/8"	7/32"	1"
1/2" NPT	10-12NFD	10,000	NFD	5/16"	0.18	5 3/4"	2 5/8"	—	1 1/2"	3 1/4"	1/2"	1 5/8"	5/16"	1 1/2"

\* For valves requiring high temperature Grafoil packing in the 1/8" NPT, or 1/4" NPT or 3/8" NPT sizes, add suffix "-W" to catalog number. (Example 10-11NFB-W.)



## Pipe Connection Valves

### Female NPT/10,000 and 15,000 psi

**1/8" • 1/4" • 3/8" • 1/2" NPT • 3/4" NPT • 1" NPT**

**Non-rotating slotted stems** are standard for on-off service and insure long life on valve seats. Regulating tip stems are available for all valves at no additional cost.

**Materials** include high tensile Type 316 stainless steel for valve bodies, and hardened 17-4PH stainless steel for lower section stems.

**Packing** is Teflon (450°F) standard with optional Viton (350°F), BUNA-N (200°F) and Grafoil (650°F) available at no additional cost.

**Air operators** for remote control operation are available for all valves. (See Air Operator section of catalog.)

**Extreme temperatures** can be accommodated by using extended stuffing boxes (See Valve Options, page 22).

**3**

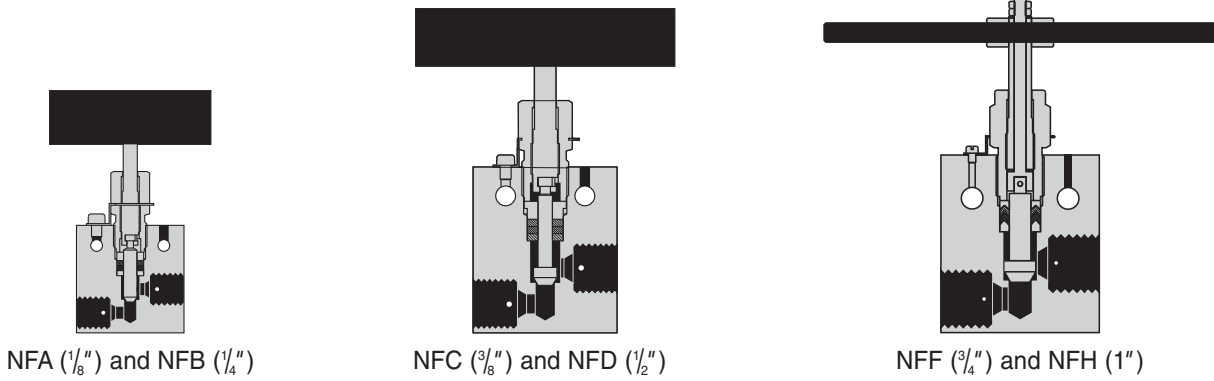

NFA (1/8") and NFB (1/4")

NFC (3/8") and NFD (1/2")

NFF (3/4") and NFH (1")

## Two Way Straight Valves

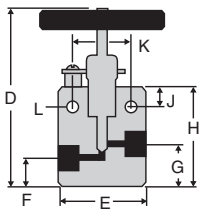

Pipe Size	Catalog No.*	psi	Conn.	Orifice	Cv	D	E	F	G	H	J	K	L	Thickness
1/8" NPT	15F-11NFA	15,000	NFA	.203	0.45	4 3/8"	2"	3/8"	13/16"	2"	3/8"	1 1/4"	7/32"	3/4"
1/4" NPT	15F-11NFB	15,000	NFB	.203	0.45	4 3/8"	2"	3/8"	13/16"	2"	3/8"	1 1/4"	7/32"	3/4"
3/8" NPT	15F-11NFC	15,000	NFC	.312	1.12	6 1/8"	2 1/2"	1/2"	1 1/8"	2 7/8"	1/2"	1 3/8"	11/32"	1"
1/2" NPT	15F-11NFD	15,000	NFD	.312	1.12	6 3/8"	2 5/8"	3/4"	1 3/8"	3 1/8"	1/2"	1 3/8"	11/32"	1 1/2"
3/4" NPT	10F-11NFF	10,000	NFF	.687	5.91	8 1/2"	4 1/8"	7/8"	1 13/16"	4 5/8"	1 1/8"	2 1/2"	9/16"	1 3/4"
1" NPT	10F-11NFH	10,000	NFH	.687	5.91	8 1/2"	4 1/8"	7/8"	1 13/16"	4 5/8"	1 1/8"	2 1/2"	9/16"	1 3/4"

## Two Way Angle Valves

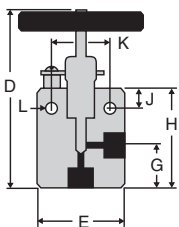

Pipe Size	Catalog No.*	psi	Conn.	Orifice	Cv	D	E	F	G	H	J	K	L	Thickness
1/8" NPT	15F-12NFA	15,000	NFA	.203	0.675	4 13/16"	2"	—	1 1/4"	2 7/16"	3/8"	1 1/4"	7/32"	3/4"
1/4" NPT	15F-12NFB	15,000	NFB	.203	0.675	4 13/16"	2"	—	1 1/4"	2 7/16"	3/8"	1 1/4"	7/32"	3/4"
3/8" NPT	15F-12NFC	15,000	NFC	.312	1.68	6 1/2"	2 1/2"	—	1 1/2"	3 1/4"	1/2"	1 3/8"	11/32"	1"
1/2" NPT	15F-12NFD	15,000	NFD	.312	1.68	6 1/2"	2 5/8"	—	1 1/2"	3 1/4"	1/2"	1 3/8"	11/32"	1 1/2"
3/4" NPT	10F-12NFF	10,000	NFF	.687	8.865	9"	4 1/8"	—	2 5/16"	5 1/8"	1 1/8"	2 1/2"	9/16"	1 3/4"
1" NPT	10F-12NFH	10,000	NFH	.687	8.865	9"	4 1/8"	—	2 5/16"	5 1/8"	1 1/8"	2 1/2"	9/16"	1 3/4"

\* For valves requiring high temperature packing in the 1/8" NPT, or 1/4" NPT or 3/8" NPT sizes, add suffix "-W" to catalog number. (Example 10-11NFB-W.)

# NPT Valve Options

## Extreme Temperature Valves

The Extreme Temperature Extension provides a means to move the packing area (stuffing box) away from the hot or cold zone of a valve. Fins are provided around the packing area to dissipate heat or cold with this option.

**Size range.** Extreme temperature extensions are available for all NPT valves.

**Materials and features.** Standard packing is Grafoil and Teflon. Nonrotating tip stems prevent galling at the seats and minimize torque requirements for positive shut off.

**When ordering,** simply add the suffix “-HT” or “-LT” to the standard valve catalog number (example: 15F-11NFA-HT).

Temperature ratings of valves with this option, for low temperature (-LT) is -423°F (-252°C) and for high temperature (-HT) is 1200°F (649°C)

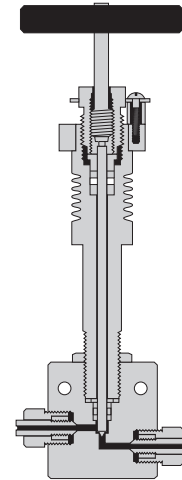

3

## Micro Control Metering Valves

The Micro Control Metering Valve assembly is available for 1/8", 1/4" NPT valves in this section. This unique stem design operates on the principle of a right-hand threaded component operating in an opposite direction of motion to a left-hand threaded component.

As the pitch sizes of these threads are different from each other, a very fine and precise stem travel is made possible. This provides exceptional control that is not possible with ordinary fine pitched stem designs.

Each complete revolution of the stem provides 0.005" stem travel. The vernier indicator allows readings in increments of one-tenth of a revolution (0.0005" stem travel).

**The non-rotating lower section stem** is ground to a 9 degree included angle to insure maximum control. **While this valve may be turned to the fully off (closed) position, it is always preferable to provide a separate on-off valve in the system to protect the precise control of the metering valve.**

**When ordering,** simply specify the valve catalog number from the valve series and add the suffix “-V” (example: 15F-11NFB-V)

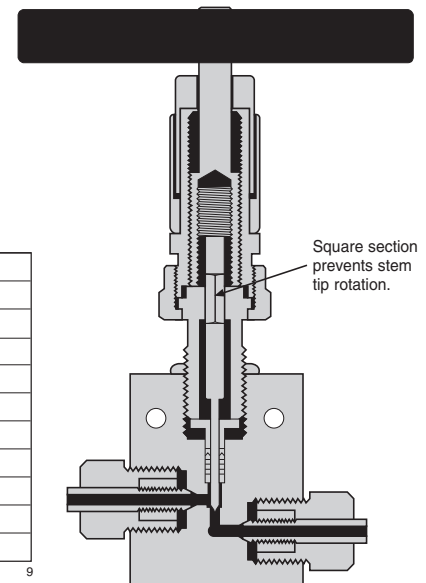
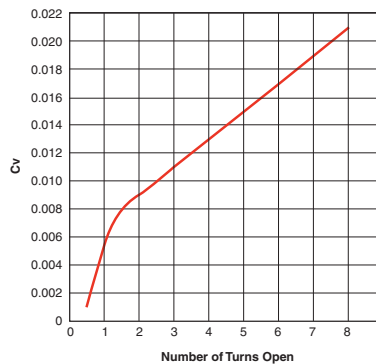

## Special Materials

A large number of the valves and fittings shown within this catalog section are frequently furnished in special materials to meet the requirements of specific applications. One of the most commonly requested “special” materials is Hastelloy C-276.

**Tubing collars and glands** for High Pressure coned-and-threaded connections are “non-wetted” parts which do not normally come into contact with the fluid or gas. Thus these items are supplied in 316 stainless steel unless otherwise specified.

**Packing material** in all special material valves is Teflon unless otherwise specified.

**Other materials.** In addition to Hastelloy C-276, valves and fittings can be furnished in Monel, Inconel and titanium. Consult factory for price and delivery.

## Packing Options

### NPT Hand Valves

#### 10,000 psi Series

Material	Part Number		
	NFA/NFB/NFC	NFD	NFF - NFH
Teflon*	B-181	B-185	208741 Set
Grafoil	B-1417	B-1359	—
Buna-N	B-102	—	—
Viton	B-849	—	—
Silicone	B-147	—	—

#### 15,000 psi Series

Material	Part Number	
	NFA NFB	NFC NFD
Teflon*	B-1392 Set	207341 Set
Grafoil	B-1391 Set	B-1386 Set
Polypak	B-1388 (1)	B-1387 (1)

## Elbows/Tees/Crosses

A complete range of elbows, tees, and crosses is available for all of the tubing connection sizes. Material is high tensile 316 stainless steel.

### NPT Elbows

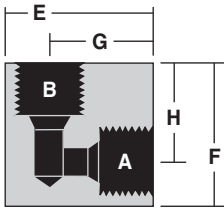

Catalog No.	Pressure Rating psi	Connections	A-B	E	F	G	H	Thickness
15-22NFA	15,000	1/8" FNPT	NFA	1 1/2"	1 1/2"	1"	1"	3/4"
15-22NFB	15,000	1/4" FNPT	NFB	1 1/2"	1 1/2"	1"	1"	1"
15-22NFC	15,000	3/8" FNPT	NFC	1 1/2"	1 1/2"	1"	1"	1"
15-22NFD	15,000	1/2" FNPT	NFD	2 5/8"	1 7/8"	1 7/8"	1 1/8"	1 1/2"
10-22NFF	10,000	3/4" FNPT	NFF	2 5/8"	2 5/16"	1 5/16"	1 3/8"	1 1/2"
10-22NFH	10,000	1" FNPT	NFH	3"	3"	2 1/16"	2 1/16"	1 3/4"

3

### NPT Tees

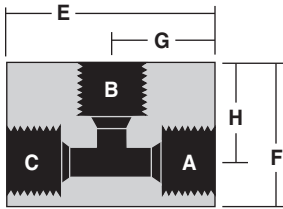

Catalog No.	Pressure Rating psi	Connections	A-B	E	F	G	H	Thickness
15-23NFA	15,000	1/8" FNPT	NFA	1 1/2"	1 1/4"	3/4"	3/4"	3/4"
15-23NFB	15,000	1/4" FNPT	NFB	2"	1 1/2"	1"	1"	1"
15-23NFC	15,000	3/8" FNPT	NFC	2"	1 1/2"	1"	1"	1"
15-23NFD	15,000	1/2" FNPT	NFD	2 5/8"	2 1/8"	1 5/16"	1 3/8"	1 1/2"
10-23NFF	10,000	3/4" FNPT	NFF	2 5/8"	2 1/8"	1 5/16"	1 3/8"	1 1/2"
10-23NFH	10,000	1" FNPT	NFH	4 1/8"	3"	2 1/16"	2 1/16"	1 3/4"

### NPT Crosses

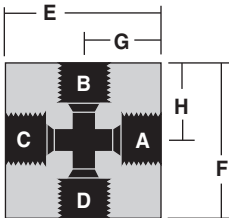

Catalog No.	Pressure Rating psi	Connections	A-B	E	F	G	H	Thickness
15-24NFA	15,000	1/8" FNPT	NFA	1 1/2"	1 1/2"	3/4"	3/4"	3/4"
15-24NFB	15,000	1/4" FNPT	NFB	2"	2"	1"	1"	1"
15-24NFC	15,000	3/8" FNPT	NFC	2"	2"	1"	1"	1"
15-24NFD	15,000	1/2" FNPT	NFD	2 5/8"	2 3/4"	1 5/16"	1 3/8"	1 1/2"
10-24NFF	10,000	3/4" FNPT	NFF	2 5/8"	2 3/4"	1 5/16"	1 3/8"	1 1/2"
10-24NFH	10,000	1" FNPT	NFH	4 1/8"	4 1/8"	2 1/16"	2 1/16"	1 3/4"

# NPT Valves

## NPT Straight Couplings

Standard material is high tensile 316 stainless steel.

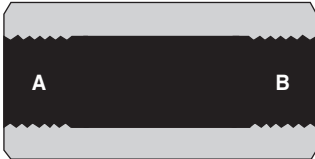

Catalog No.	Pressure Rating psi	Connections	A-B	Length	Hex
15-21NFA	15,000	1/8" FNPT	NFA	1 1/4"	3/4"
15-21NFB	15,000	1/4" FNPT	NFB	1 3/4"	1"
15-21NFC	15,000	3/8" FNPT	NFC	1 3/8"	1"
15-21NFD	15,000	1/2" FNPT	NFD	1 7/8"	1 3/8"
10-21NFF	10,000	3/4" FNPT	NFF	2 1/2"	1 3/8"
10-21NFH	10,000	1" FNPT	NFH	2 1/2"	1 3/4"

3

## NPT Bulkhead Couplings

Bulkhead couplings are designed specifically for passing a tubing connection through a panel or steel barricade. These couplings include a locknut as shown. Material is high tensile 316 stainless steel.

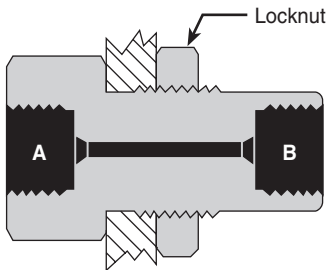

Catalog No.	Pressure Rating psi	Connections	Panel Hole	A-B	Length	Hex	Outside Thread	Max Panel Thickness
15-21NFA-B	15,000	1/8" FNPT	15/16"	NFA	2 1/8"	1"	7/8" - 14	7/16"
15-21NFB-B	15,000	1/4" FNPT	15/16"	NFB	2 1/8"	1"	7/8" - 14	1 3/8"
15-21NFC-B	15,000	3/8" FNPT	1 1/8"	NFC	2 3/8"	1 3/8"	1 1/16" - 12	17/32"
15-21NFD-B	15,000	1/2" FNPT	1 7/16"	NFD	2 3/8"	1 1/2"	1 3/8" - 12	1 5/8"
10-21NFF-B	10,000	3/4" FNPT	1 11/16"	NFF	2 5/8"	1 7/8"	1 5/8" - 12	1 11/16"
10-21NFH-B	10,000	1" FNPT	1 15/16"	NFH	3 1/2"	2 1/8"	1 7/8" - 12	1 15/16"

## NPT Caps

Tubing end caps are offered for use in sealing off tubing ends either for temporary use or permanent use such as on small volume reservoirs. Standard material is high tensile 316 stainless steel.

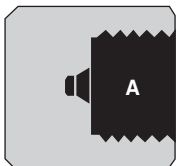

Catalog No.	Pressure Rating psi	Pipe Size	A	Length	Hex
15-21NFA-C	15,000	1/8"	NFA	3/4"	3/4"
15-21NFB-C	15,000	1/4"	NFB	1"	1"
15-21NFC-C	15,000	3/8"	NFC	1 1/4"	1"
15-21NFD-C	15,000	1/2"	NFD	1 1/2"	1 3/8"
10-21NFF-C	10,000	3/4"	NFF	1 3/4"	1 3/8"
10-21NFH-C	10,000	1"	NFH	1 3/4"	1 3/4"



## NPT Line Filters

The line filters as shown utilize sintered stainless steel filter discs 4 pc./set. Porosities are available as per the chart to the right. If not otherwise specified, 100 micron filter discs are supplied. (One micron = 0.001 millimeters). Material of body, caps and cover is hightensile 316 stainless steel.

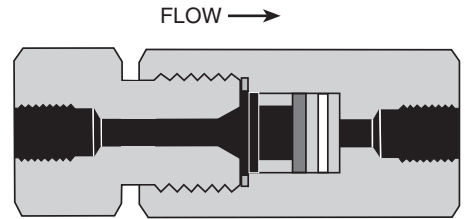

Catalog No.	Pressure Rating psi	Connections	A-B	Length	Hex	Micron Size Filter Available					
						0.5	2	5	10	40	100
15-51NFA	15,000	1/8" FNPT	NFA	3 3/16"	1 3/8"	●	●	●	●	●	●
15-51NFB	15,000	1/4" FNPT	NFB	4 3/16"	1 3/8"	●	●	●	●	●	●
15-51NFC	15,000	3/8" FNPT	NFC	4 3/16"	1 3/8"	●	●	●	●	●	●
15-51NFD	15,000	1/2" FNPT	NFD	4 3/16"	1 3/8"	●	●	●	●	●	●

3

## NPT Ball Check Valves

Ball type check valves insure flow in one direction only. Material for body, caps and cover is high tensile 316 stainless steel.

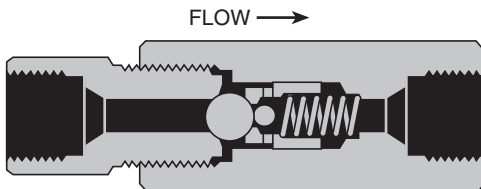

Catalog No.	Pressure Rating psi	Connections	A-B	Length	Hex
15-41NFA	15,000	1/8" FNPT	NFA	4 5/32"	1"
15-41NFB	15,000	1/4" FNPT	NFB	4 5/32"	1"
15-41NFC	15,000	3/8" FNPT	NFC	4 5/32"	1"
15-41NFD	15,000	1/2" FNPT	NFD	4 9/16"	1 3/8"
10-41NFF	10,000	3/4" FNPT	NFF	5 5/16"	1 3/8"
10-41NFH	10,000	1" FNPT	NFH	7 1/8"	2 1/2"

## NPT Softseat Check Valves

Soft seat check valves insure flow in one direction only and can be mounted in any position. These are highly reliable for both gas and liquid service. Standard O-ring (soft seat) material for the sealing surface is Buna-N (nitrile) for 1/8" - 1/2" size with other materials including Teflon and Viton available on request. Temperature is limited by the choice of O-ring material. Material of all other parts is high tensile 316 stainless steel.

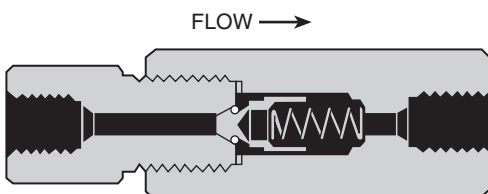

Catalog No.	Pressure Rating psi	Connections	A-B	Length	Hex
15-41NFA-T	15,000	1/8" FNPT	NFA	4 5/32"	1"
15-41NFB-T	15,000	1/4" FNPT	NFB	4 5/32"	1"
15-41NFC-T	15,000	3/8" FNPT	NFC	4 5/32"	1"
15-41NFD-T	15,000	1/2" FNPT	NFD	4 9/16"	1 3/8"
10-41NFF-T	10,000	3/4" FNPT	NFF	5 5/16"	1 3/8"
10-41NFH-T	10,000	1" FNPT	NFH	7 1/8"	2 1/2"

# NPT Valves

## NPT Safety Heads

3

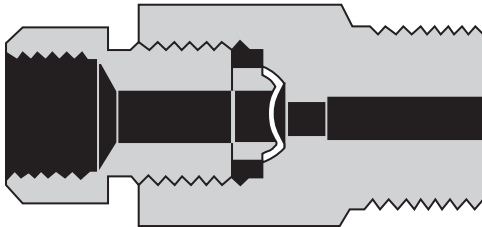

The male inlet design can be inserted directly into the tubing connections of valves and various fittings such as tees and crosses, or located in pressure vessels.

Outlet connections are  $\frac{3}{8}$ " pipe (NPT). This outlet may be connected to a suitable discharge line to vent pressure to a safe location in the event of bursting of the rupture disc. Torque required for sealing rupture discs will range from 40 to 90 foot pounds, depending upon pressure and media being used.

Material of body and hold down nut is high tensile 316 stainless steel.

**Note:** Rupture discs are **not** included and must be ordered as a separate item.

**CE marked safety heads are now available, add -CE to end of standard part number. Consult factory for pricing.**

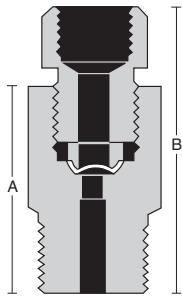

### Male Inlet Safety Heads

Catalog No.	Pressure Rating psi	Male Inlet Connection	A	B	Hex Size
15-61NMA	15,000	$\frac{1}{8}$ " Pipe	$1\frac{7}{8}$ "	$2\frac{7}{8}$ "	1"
15-61NMB	15,000	$\frac{1}{4}$ " Pipe	2"	3"	1"
15-61NMC	15,000	$\frac{3}{8}$ " Pipe	2"	3"	1"
15-61NMD	15,000	$\frac{1}{2}$ " Pipe	2"	3"	1"

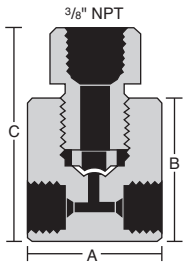

### Tee Type Safety Heads

Catalog No.	Pressure Rating psi	Inlet Connection	A	B	Thickness
15-63NFA	15,000	$\frac{1}{8}$ " Pipe	2"	$1\frac{3}{4}$ "	$2\frac{3}{4}$ "
15-63NFB	15,000	$\frac{1}{4}$ " Pipe	2"	$1\frac{3}{4}$ "	$2\frac{3}{4}$ "
15-63NFC	15,000	$\frac{3}{8}$ " Pipe	$2\frac{5}{8}$ "	2"	3"
15-63NFD	15,000	$\frac{1}{2}$ " Pipe	$2\frac{5}{8}$ "	$2\frac{5}{8}$ "	$3\frac{5}{8}$ "

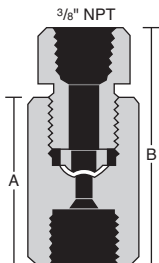

### Female Inlet (Straight) Safety Heads

Catalog No.	Pressure Rating psi	Inlet Connection	A	B	Hex Size
15-61NFA	15,000	$\frac{1}{8}$ " Pipe	2"	3"	1"
15-61NFB	15,000	$\frac{1}{4}$ " Pipe	2"	3"	1"
15-61NFC	15,000	$\frac{3}{8}$ " Pipe	$2\frac{5}{16}$ "	$3\frac{5}{16}$ "	$1\frac{1}{8}$ "
15-61NFD	15,000	$\frac{1}{2}$ " Pipe	$2\frac{5}{16}$ "	$3\frac{5}{16}$ "	$1\frac{1}{8}$ "

**Rupture Discs**  
**1/4" Angled Seat**

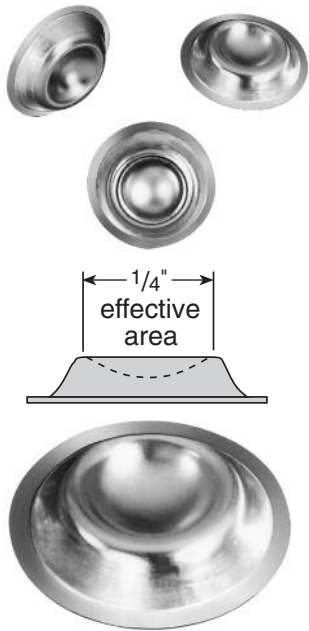

**SPECIAL DISCS** are available on special order for pressure ranges not shown below and in numerous materials and coatings. Consult factory for price and delivery.

Standard rupture discs are available from stock in burst pressures as listed in the chart below. All pressures through 15,000 psi are shaded. These discs are 316 stainless steel (except for 1,000 psi which are inconel) and may be used with any of the safety heads shown. Note that these rupture discs are supplied with a range of plus 6% and minus 3% of specified burst pressure. Samples of each batch are then tested and typically the actual average burst pressure is stamped on an accompanying metal tag. There is a +/- 5% burst tolerance applied after the burst pressure has been established. Factors influencing rupture =disc life include corrosion, metal fatigue, and cyclic effects. Periodic replacement is recommended to prevent premature failure.

**3**

**Standard Burst Pressures (in psi at 72°F)**

1,000	3,000	5,000	7,000	9,000	11,000	17,500	25,000	37,500	55,000
1,500	3,500	5,500	7,500	9,500	11,500	18,000	27,000	40,000	60,000
2,000	4,000	6,000	8,000	10,000	12,500	20,000	30,000	45,000	65,000
2,500	4,500	6,500	8,500	10,500	15,000	22,500	35,000	50,000	



# High Pressure Equipment

## Medium Pressure Valves, Fittings and Tubing 20,000 psi service

High Pressure Equipment Company has developed a line of Medium Pressure products to assure safe and easy plumbing through 20,000 psi. These needle valves, fittings, line filters, check valves, safety heads, rupture discs, anti-vibration gland assemblies, tubing and nipples are engineered to the highest standards of repeatable quality. The reliable performance of these products has made HiP one of the world's leading suppliers of elevated pressure components.

Medium Pressure components use a compact coned-and-threaded connection which permits the larger bore sizes and increased flow rates common in this pressure class. Medium Pressure valves are available in  $\frac{1}{4}$ ",  $\frac{3}{8}$ ",  $\frac{9}{16}$ ",  $\frac{3}{4}$ ", 1" and  $1\frac{1}{2}$ " O.D. tubing sizes and six patterns to satisfy widely varied requirements. A line of fittings is available to facilitate adapting to Taper Seal, High Pressure or other threaded pipe systems.



### Index

20,000 psi Valves*	29-30
Valve Options	31
Fittings	32
Unions, Bulkheads & Caps	33
Line Filters & Check Valves	34
Safety Heads	35
Rupture Discs	36
Anti-Vibration Gland Assemblies	37
Tubing	38
Coned & Threaded Nipples	38
Connection Details	39

\*Note: 10,000 psi large orifice is offered in  $\frac{3}{4}$ " and 1" size.



**Medium Pressure (coned & threaded)** type connections for  $\frac{1}{4}$ ",  $\frac{3}{8}$ ",  $\frac{9}{16}$ ",  $\frac{3}{4}$ ", 1" and  $1\frac{1}{2}$ " O.D. tubing.

**Non-rotating slotted stems** are standard on LF4, LF6 and LF9 for on-off service and ensure long life on valve seats. Regulating tip stems are available for all valves at no additional cost, add - REG to part number.

**Glands and collars** for tubing are supplied with each valve unless otherwise requested (glands and collars shown on pages 32 and 39).

**Materials** include high tensile type 316 stainless steel bodies and hardened 17-4PH stainless steel lower section stems.  $\frac{1}{2}$ " O.D. valves are constructed of 2205 duplex.

**Packing** is Teflon (450°F) standard with optional Viton (350°F), BUNA-N (200°F) and Grafoil (800°F) available at no additional cost.

**Air operators** for remote control operation are available for all valves. (Refer to Air Operator section of catalog for additional data).

**Extreme temperatures** can be accommodated by using extended stuffing boxes (See Valve Options, page 31).

4

**Valve Features**

- Non-rotating slotted stem design (standard for LF4, LF6 and LF9)
- Packing below stem threads
- Positive gland lock device
- Tube sizes  $\frac{1}{4}$ " through  $1\frac{1}{2}$ "
- Type 316 ss high tensile bodies
- No stem adjustment needed – LF4, LF6 and LF9
- Black T-handles or choice of 4 colors – LF4, LF6 and LF9
- 316 ss handles LF12, LF16 and LF24

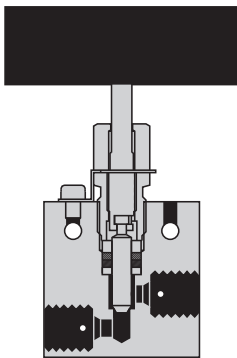

LF4 ( $\frac{1}{4}$ " ) and LF6 ( $\frac{3}{8}$ " )

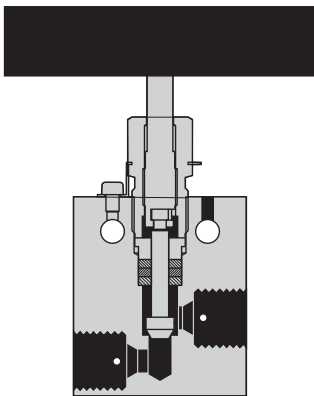

LF9 ( $\frac{9}{16}$ " )

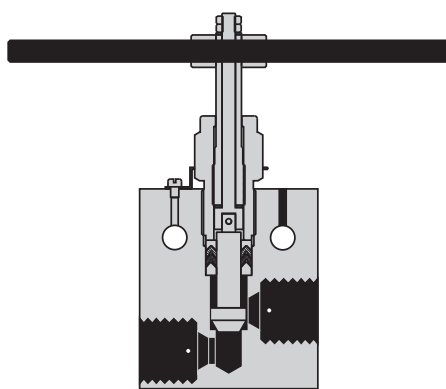

LF12 ( $\frac{3}{4}$ " ) and LF16 (1" )\*

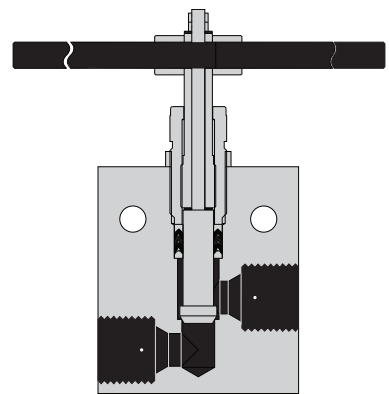

LF24 ( $1\frac{1}{2}$ " ) (Rated to 15,000 psi)

\* Note: 10,000 psi large orifice is offered in  $\frac{3}{4}$ " and 1" size.



# Medium Pressure Valves

## Two Way Straight Valves

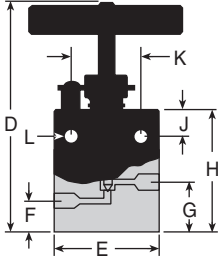

Tubing	Catalog No.	psi	Conn.	Orifice	Cv	D	E	F	G	H	J	K	L	Thickness
1/4" O.D.	20-11LF4	20,000	LF4	1/8"	0.17	4 <sup>3</sup> / <sub>16</sub> "	2"	3/8"	1 <sup>3</sup> / <sub>16</sub> "	2"	3/8"	1 1/4"	7/32"	3/4"
3/8" O.D.	20-11LF6	20,000	LF6	1 <sup>3</sup> / <sub>64</sub> "	0.45	4 <sup>3</sup> / <sub>16</sub> "	2"	3/8"	1 <sup>3</sup> / <sub>16</sub> "	2"	3/8"	1 1/4"	7/32"	3/4"
9/16" O.D.	20-11LF9	20,000	LF9	5/16"	1.12	6 <sup>1</sup> / <sub>8</sub> "	2 1/2"	1 1/2"	1 1/8"	2 7/8"	1 1/2"	1 3/8"	11/32"	1"
3/4" O.D.	20-11LF12	20,000	LF12	7/16"	2.29	7"	3"	3/4"	1 1/2"	3 3/4"	5/8"	1 3/4"	7/16"	1 3/8"
3/4" O.D.	10-11LF12	10,000	LF12	3 <sup>3</sup> / <sub>64</sub> "	3.65	7"	3"	3/4"	1 1/2"	3 3/4"	5/8"	1 3/4"	7/16"	1 3/8"
1" O.D.	20-11LF16	20,000	LF16	9/16"	3.86	8 <sup>2</sup> / <sub>16</sub> "	4 1/8"	7/8"	1 13/16"	4 5/8"	1 1/8"	2 1/2"	9/16"	1 3/4"
1" O.D.	10-11LF16	10,000	LF16	11/16"	5.91	8 <sup>2</sup> / <sub>16</sub> "	4 1/8"	7/8"	1 13/16"	4 5/8"	1 1/8"	2 1/2"	9/16"	1 3/4"
1 1/2" O.D.	15-11LF24	15,000	LF24	1 <sup>5</sup> / <sub>16</sub> "	—	9 <sup>5</sup> / <sub>16</sub> "	5 1/4"	1 1/4"	2 3/4"	6 1/2"	1 1/2"	3 3/4"	3/4"	2 1/4"

## Two Way Angle Valves

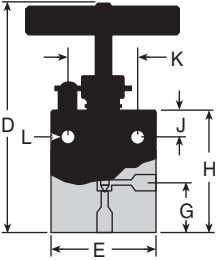

Tubing	Catalog No.	psi	Conn.	Orifice	Cv	D	E	F	G	H	J	K	L	Thickness
1/4" O.D.	20-12LF4	20,000	LF4	1/8"	0.255	4 <sup>13</sup> / <sub>16</sub> "	2"	—	1 1/4"	2 <sup>1</sup> / <sub>16</sub> "	3/8"	1 1/4"	7/32"	3/4"
3/8" O.D.	20-12LF6	20,000	LF6	1 <sup>3</sup> / <sub>64</sub> "	0.675	4 <sup>13</sup> / <sub>16</sub> "	2"	—	1 1/4"	2 <sup>1</sup> / <sub>16</sub> "	3/8"	1 1/4"	7/32"	3/4"
9/16" O.D.	20-12LF9	20,000	LF9	5/16"	1.68	6 <sup>5</sup> / <sub>8</sub> "	2 1/2"	—	1 5/8"	3 3/8"	1 1/2"	1 3/8"	11/32"	1"
3/4" O.D.	20-12LF12	20,000	LF12	7/16"	3.435	7 1/2"	3"	—	2"	4 1/4"	5/8"	1 3/4"	7/16"	1 3/8"
3/4" O.D.	10-12LF12	10,000	LF12	3 <sup>3</sup> / <sub>64</sub> "	5.475	7 1/2"	3"	—	2"	4 1/4"	5/8"	1 3/4"	7/16"	1 3/8"
1" O.D.	20-12LF16	20,000	LF16	9/16"	5.79	9 3/8"	4 1/8"	—	2 <sup>9</sup> / <sub>16</sub> "	5 1/16"	1 1/8"	2 1/2"	9/16"	1 3/4"
1" O.D.	10-12LF16	10,000	LF16	11/16"	8.865	9 3/8"	4 1/8"	—	2 <sup>9</sup> / <sub>16</sub> "	5 1/16"	1 1/8"	2 1/2"	9/16"	1 3/4"
1 1/2" O.D.	15-12LF24	15,000	LF24	1 <sup>5</sup> / <sub>16</sub> "	—	9 <sup>6</sup> / <sub>16</sub> "	5 3/4"	—	3"	6 3/4"	1 1/2"	3 3/4"	3/4"	2 1/4"

## Three Way Valves / Two Pressure Connections

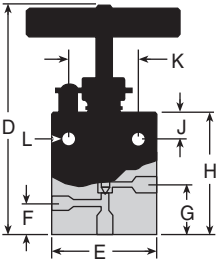

Tubing	Catalog No.	psi	Connection	Orifice	D	E	F	G	H	J	K	L	Thickness
1/4" O.D.	20-13LF4	20,000	LF4	1/8"	5"	2"	1"	1 7/16"	2 <sup>5</sup> / <sub>8</sub> "	3/8"	1 1/4"	7/32"	3/4"
3/8" O.D.	20-13LF6	20,000	LF6	1 <sup>3</sup> / <sub>64</sub> "	5"	2"	1"	1 7/16"	2 <sup>5</sup> / <sub>8</sub> "	3/8"	1 1/4"	7/32"	3/4"
9/16" O.D.	20-13LF9	20,000	LF9	5/16"	6 <sup>1</sup> / <sub>8</sub> "	2 1/2"	1 1/4"	1 7/8"	3 <sup>5</sup> / <sub>8</sub> "	1 1/2"	1 3/8"	11/32"	1"
3/4" O.D.	20-13LF12	20,000	LF12	7/16"	7 1/8"	3"	2 <sup>5</sup> / <sub>8</sub> "	2 <sup>3</sup> / <sub>8</sub> "	4 <sup>5</sup> / <sub>8</sub> "	5/8"	1 3/4"	7/16"	1 3/8"
3/4" O.D.	10-13LF12	10,000	LF12	3 <sup>3</sup> / <sub>64</sub> "	7 1/8"	3"	2 <sup>5</sup> / <sub>8</sub> "	2 <sup>3</sup> / <sub>8</sub> "	4 <sup>5</sup> / <sub>8</sub> "	5/8"	1 3/4"	7/16"	1 3/8"
1" O.D.	20-13LF16	20,000	LF16	9/16"	9 3/4"	4 1/8"	2 1/8"	3 <sup>1</sup> / <sub>16</sub> "	5 7/8"	1 1/8"	2 1/2"	9/16"	1 3/4"
1" O.D.	10-13LF16	10,000	LF16	11/16"	9 3/4"	4 1/8"	2 1/8"	3 <sup>1</sup> / <sub>16</sub> "	5 7/8"	1 1/8"	2 1/2"	9/16"	1 3/4"

## Three Way Valves / One Pressure Connection

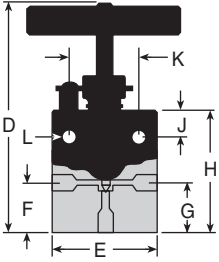

Tubing	Catalog No.	psi	Connection	Orifice	D	E	F	G	H	J	K	L	Thickness
1/4" O.D.	20-14LF4	20,000	LF4	1/8"	4 <sup>13</sup> / <sub>16</sub> "	2"	1 1/4"	1 1/4"	2 <sup>1</sup> / <sub>16</sub> "	3/8"	1 1/4"	7/32"	3/4"
3/8" O.D.	20-14LF6	20,000	LF6	1 <sup>3</sup> / <sub>64</sub> "	4 <sup>13</sup> / <sub>16</sub> "	2"	1 1/4"	1 1/4"	2 <sup>1</sup> / <sub>16</sub> "	3/8"	1 1/4"	7/32"	3/4"
9/16" O.D.	20-14LF9	20,000	LF9	5/16"	6 <sup>5</sup> / <sub>8</sub> "	2 1/2"	1 5/8"	1 5/8"	3 3/8"	1 1/2"	1 3/8"	11/32"	1"
3/4" O.D.	20-14LF12	20,000	LF12	7/16"	7 1/2"	3"	2"	2"	4 1/4"	5/8"	1 3/4"	7/16"	1 3/8"
3/4" O.D.	10-14LF12	10,000	LF12	3 <sup>3</sup> / <sub>64</sub> "	7 1/2"	3"	2"	2"	4 1/4"	5/8"	1 3/4"	7/16"	1 3/8"
1" O.D.	20-14LF16	20,000	LF16	9/16"	9 3/8"	4 1/8"	2 <sup>5</sup> / <sub>8</sub> "	2 <sup>5</sup> / <sub>8</sub> "	5 1/16"	1 1/8"	2 1/2"	9/16"	1 3/4"
1" O.D.	10-14LF16	10,000	LF16	11/16"	9 3/8"	4 1/8"	2 <sup>5</sup> / <sub>8</sub> "	2 <sup>5</sup> / <sub>8</sub> "	5 1/16"	1 1/8"	2 1/2"	9/16"	1 3/4"

## Three Way / Two Stem Connection Valves

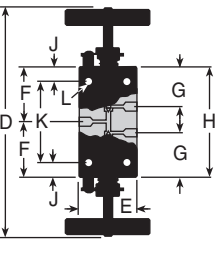

Tubing	Catalog No.	psi	Connection	Orifice	D	E	F	G	H	J	K	L	Thickness
1/4" O.D.	20-15LF4	20,000	LF4	1/8"	5 <sup>3</sup> / <sub>4</sub> "	2"	1 11/16"	1 <sup>3</sup> / <sub>16</sub> "	3 <sup>3</sup> / <sub>8</sub> "	3/8"	1 1/4"	7/32"	3/4"
3/8" O.D.	20-15LF6	20,000	LF6	1 <sup>3</sup> / <sub>64</sub> "	5 <sup>3</sup> / <sub>4</sub> "	2"	1 11/16"	1 <sup>3</sup> / <sub>16</sub> "	3 <sup>3</sup> / <sub>8</sub> "	3/8"	1 1/4"	7/32"	3/4"
9/16" O.D.	20-15LF9	20,000	LF9	5/16"	8 <sup>7</sup> / <sub>8</sub> "	2 1/2"	2 <sup>9</sup> / <sub>16</sub> "	1 3/4"	5 1/8"	1 1/2"	1 3/8"	11/32"	1"
3/4" O.D.	20-15LF12	20,000	LF12	7/16"	9 <sup>3</sup> / <sub>4</sub> "	3"	3 3/4"	2 1/4"	6 1/2"	5/8"	1 3/4"	7/16"	1 3/8"
3/4" O.D.	10-15LF12	10,000	LF12	3 <sup>3</sup> / <sub>64</sub> "	9 <sup>3</sup> / <sub>4</sub> "	3"	3 3/4"	2 1/4"	6 1/2"	5/8"	1 3/4"	7/16"	1 3/8"
1" O.D.	20-15LF16	20,000	LF16	9/16"	12 <sup>3</sup> / <sub>16</sub> "	4 1/8"	4 1/8"	2 <sup>13</sup> / <sub>16</sub> "	8 1/4"	1 1/8"	2 1/2"	9/16"	1 3/4"
1" O.D.	10-15LF16	10,000	LF16	11/16"	12 <sup>3</sup> / <sub>16</sub> "	4 1/8"	4 1/8"	2 <sup>13</sup> / <sub>16</sub> "	8 1/4"	1 1/8"	2 1/2"	9/16"	1 3/4"

## Replaceable Seat Valves

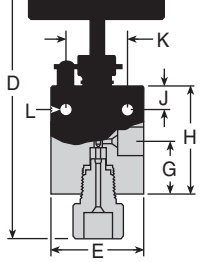

Tubing	Catalog No.	psi	Connection	Orifice	D	E	F	G	H	J	K	L	Thickness
1/4" O.D.	20-12LF4-R	20,000	LF4	1/8"	5 <sup>5</sup> / <sub>8</sub> "	2"	—	1 1/4"	2 <sup>1</sup> / <sub>16</sub> "	3/8"	1 1/4"	7/32"	3/4"
3/8" O.D.	20-12LF6-R	20,000	LF6	1 <sup>3</sup> / <sub>64</sub> "	5 <sup>5</sup> / <sub>8</sub> "	2"	—	1 1/4"	2 <sup>1</sup> / <sub>16</sub> "	3/8"	1 1/4"	7/32"	3/4"
9/16" O.D.	20-12LF9-R	20,000	LF9	5/16"	8"	2 1/2"	—	1 5/8"	3 3/8"	1 1/2"	1 3/8"	11/32"	1"
3/4" O.D.	20-12LF12-R	20,000	LF12	7/16"	8 <sup>7</sup> / <sub>8</sub> "	3"	—	2"	4 1/4"	5/8"	1 3/4"	7/16"	1 3/8"
3/4" O.D.	10-12LF12-R	10,000	LF12	3 <sup>3</sup> / <sub>64</sub> "	8 <sup>7</sup> / <sub>8</sub> "	3"	—	2"	4 1/4"	5/8"	1 3/4"	7/16"	1 3/8"
1" O.D.	20-12LF16-R	20,000	LF16	9/16"	11 1/8"	4 1/8"	—	2 <sup>9</sup> / <sub>16</sub> "	5 1/16"	1 1/8"	2 1/2"	9/16"	1 3/4"
1" O.D.	10-12LF16-R	10,000	LF16	11/16"	11 1/8"	4 1/8"	—	2 <sup>9</sup> / <sub>16</sub> "	5 1/16"	1 1/8"	2 1/2"	9/16"	1 3/4"

# Valve Options

## Extreme Temperature Valves

The Extreme Temperature Extension provides a means to move the packing area (stuffing box) away from the hot or cold zone of a valve. Fins are provided around the packing area to dissipate heat or cold with this option.

**Size range.** Extreme temperature extensions are available for all medium pressure valves.

**Materials and features.** Standard packing is Grafoil and Teflon. Nonrotating tip stems prevent galling at the seats and minimize torque requirements for positive shut off.

**When ordering,** simply add the suffix “-HT” or “-LT” to the standard valve catalog number (example: 20-11LF6-HT).

Temperature ratings of valves with this option, for low temperature (-LT) is -423°F (-252°C) and for high temperature (-HT) is 1200°F (649°C)

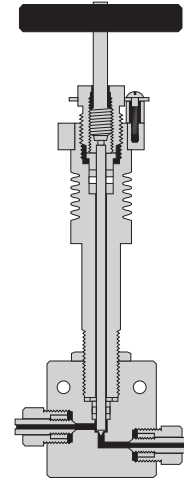

4

## Micro Control Metering Valves

The Micro Control Metering Valve assembly is available for 1/4", 3/8" valves in this section. This unique stem design operates on the principle of a right-hand threaded component operating in an opposite direction of motion to a left-hand threaded component.

As the pitch sizes of these threads are different from each other, a very fine and precise stem travel is made possible. This provides exceptional control that is not possible with ordinary fine pitched stem designs.

Each complete revolution of the stem provides 0.005" stem travel. The vernier indicator allows readings in increments of one-tenth of a revolution (0.0005" stem travel).

**The non-rotating lower section stem** is ground to a 9 degree included angle to insure maximum control. **While this valve may be turned to the fully off (closed) position, it is always preferable to provide a separate on-off valve in the system to protect the precise control of the metering valve.**

**When ordering,** simply specify the valve catalog number from the valve series and add the suffix “-V” (example: 20-11LF4-V)

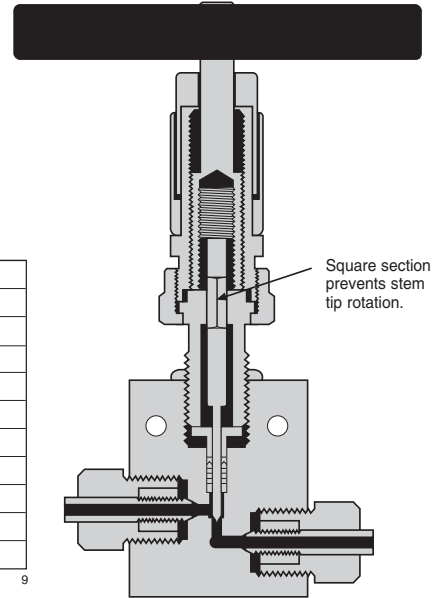
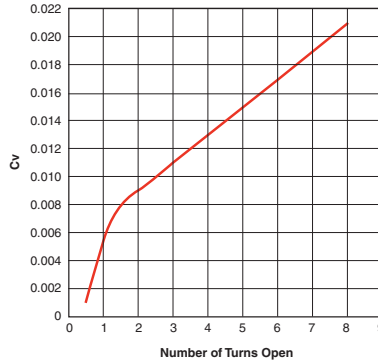

## Special Materials

A large number of the valves and fittings shown within this catalog section are frequently furnished in special materials to meet the requirements of specific applications. One of the most commonly requested “special” materials is Hastelloy C-276.

**Tubing collars and glands** for High Pressure coned-and-threaded connections are “non-wetted” parts which do not normally come into contact with the fluid or gas. Thus these items are supplied in 316 stainless steel unless otherwise specified.

**Packing material** in all special material valves is Teflon unless otherwise specified.

**Other materials.** In addition to Hastelloy C-276, valves and fittings can be furnished in Monel, Inconel and titanium. Consult factory for price and delivery.

## Packing Options

### Medium Pressure

Material	Part Number			
	LF4/ LF6	LF9	LF12	LF16
Teflon*	B-1392 Set	207341 Set	208740 Set	208741 Set
Grafoil	B-1391 Set	B-1386 Set	B-1455 Set <sup>1</sup>	B-1440 Set <sup>2</sup>
Polypak	B-1388 (1)	B-1387 (1)	B-1431 (1) <sup>1</sup>	B-1742 (1) <sup>2</sup>

<sup>1</sup> LF12 Series: When Grafoil and Polypak are used, top washer 208937 and bottom washer 208939 must be installed



<sup>2</sup> LF16 Series: When Grafoil and Polypak are used, top washer 209308 and bottom washer 209309 must be installed

# Medium Pressure Valves

## Glands/Collars/Plugs/Elbows/Tees/Crosses

A complete range of elbows, tees, and crosses is available for all of the tubing connection sizes. Material is high tensile 316 stainless steel. Standard tubing glands and collars are provided unless otherwise specified.

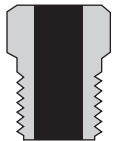
### Connection Components

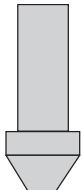
Catalog No.	Tube Size	Gland	Catalog No.	Tube Size	Collar	Catalog No.	Tube Size	Plug
20-2LM4	1/4"		20-2L4	1/4"		20-7LM4	1/4"	
20-2LM6	3/8"		20-2L6	3/8"		20-7LM6	3/8"	
20-2LM9	9/16"		20-2L9	9/16"		20-7LM9	9/16"	
20-2LM12	3/4"		20-2L12	3/4"		20-7LM12	3/4"	
20-2LM16	1"		20-2L16	1"		20-7LM16	1"	
15-2LM24	1 1/2"		15-2L24	1 1/2"		15-7LM24	1 1/2"	

### Medium Pressure Elbows

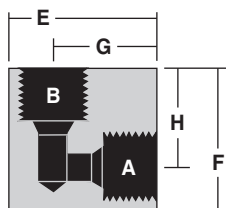

Catalog No.	Pressure Rating psi	Connections	A-B	E	F	G	H	Thickness
20-22LF4	20,000	1/4" O.D. TUBE	LF4	1 3/16"	1"	7/8"	1 1/16"	5/8"
20-22LF6	20,000	3/8" O.D. TUBE	LF6	1 3/8"	1 3/8"	1"	1"	3/4"
20-22LF9	20,000	9/16" O.D. TUBE	LF9	1 3/4"	1 3/4"	1 1/4"	1 1/4"	1"
20-22LF12	20,000	3/4" O.D. TUBE	LF12	2 1/4"	2 1/4"	1 1/2"	1 1/2"	1 3/8"
20-22LF16	20,000	1" O.D. TUBE	LF16	3"	3"	2 1/16"	2 1/16"	1 3/4"
15-22LF24	15,000	1 1/2" O.D. TUBE	LF24	5 3/4"	4"	2 7/8"	2 7/8"	2 1/4"

### Medium Pressure Tees

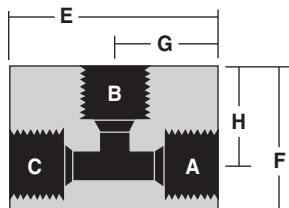

Catalog No.	Pressure Rating psi	Connections	A-B-C	E	F	G	H	Thickness
20-23LF4	20,000	1/4" O.D. TUBE	LF4	1 3/4"	1"	7/8"	1 1/16"	5/8"
20-23LF6	20,000	3/8" O.D. TUBE	LF6	2"	1 3/8"	1"	1"	3/4"
20-23LF9	20,000	9/16" O.D. TUBE	LF9	2 1/2"	1 3/4"	1 1/4"	1 1/4"	1"
20-23LF12	20,000	3/4" O.D. TUBE	LF12	3"	2 1/4"	1 1/2"	1 1/2"	1 3/8"
20-23LF16	20,000	1" O.D. TUBE	LF16	4 1/8"	3"	2 1/16"	2 1/16"	1 3/4"
15-23LF24	15,000	1 1/2" O.D. TUBE	LF24	5 3/4"	4"	2 7/8"	2 7/8"	2 1/4"

### Medium Pressure Crosses

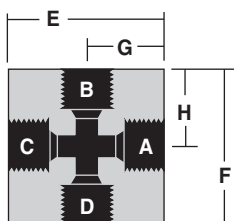

Catalog No.	Pressure Rating psi	Connections	A-B-C-D	E	F	G	H	Thickness
20-24LF4	20,000	1/4" O.D. TUBE	LF4	1 3/4"	1 3/8"	7/8"	1 1/16"	5/8"
20-24LF6	20,000	3/8" O.D. TUBE	LF6	2"	2"	1"	1"	3/4"
20-24LF9	20,000	9/16" O.D. TUBE	LF9	2 1/2"	2 1/2"	1 1/4"	1 1/4"	1"
20-24LF12	20,000	3/4" O.D. TUBE	LF12	3"	3"	1 1/2"	1 1/2"	1 3/8"
20-24LF16	20,000	1" O.D. TUBE	LF16	4 1/8"	4 1/8"	2 1/16"	2 1/16"	1 3/4"
15-24LF24	15,000	1 1/2" O.D. TUBE	LF24	5 3/4"	5 3/4"	2 7/8"	2 7/8"	2 1/4"

## Union Couplings (Slip Type)

Union (slip type) couplings are ideal for use in confined space installations. This design allows the entire coupling to be disconnected and slipped back over the tubing to facilitate assembly and disassembly. In installations where tubing is easily assembled, it is preferable (and less expensive) to use standard straight couplings (see section 12). Standard material is high tensile 316 stainless steel. Standard tubing collars and glands are provided unless otherwise specified.

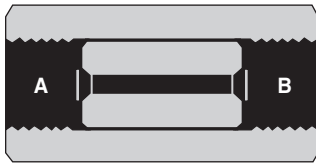

Catalog No.	Tubing	psi	A	B	Orifice	Length	Hex
20-21LF4-U	1/4" O.D.	20,000	LF4	LF4	1/8"	1 9/16"	5/8"
20-21LF6-U	3/8" O.D.	20,000	LF6	LF6	7/32"	1 3/4"	3/4"
20-21LF9-U	9/16" O.D.	20,000	LF9	LF9	23/64"	2 1/2"	1"
20-21LF12-U	3/4" O.D.	20,000	LF12	LF12	33/64"	2 1/2"	1 3/8"
20-21LF16-U	1" O.D.	20,000	LF16	LF16	11/16"	3 1/2"	1 3/4"
15-21LF24-U	1 1/2" O.D.	15,000	LF24	LF24	15/16"	5"	2 1/4"

4

## Bulkhead Couplings

Bulkhead couplings are designed specifically for passing a tubing connection through a panel or steel barricade. These couplings include a locknut as shown. Material is high tensile 316 stainless steel. Standard tubing collars and glands are included unless otherwise specified.

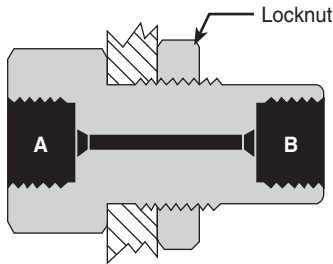

Catalog No.	Tubing	psi	Connections	Orifice	Length	Hex	Hole Diameter	Max. Panel Thickness
20-21LF4-B	1/4" O.D.	20,000	LF4	1/8"	1 7/8"	1"	13/16"	13/32"
20-21LF6-B	3/8" O.D.	20,000	LF6	7/32"	2"	1"	15/16"	7/16"
20-21LF9-B	9/16" O.D.	20,000	LF9	23/64"	2 3/8"	1 3/8"	1 1/8"	17/32"
20-21LF12-B	3/4" O.D.	20,000	LF12	33/64"	2 5/8"	1 7/8"	1 11/16"	3/8"
20-21LF16-B	1" O.D.	20,000	LF16	11/16"	3 1/2"	2 1/8"	1 15/16"	3/8"
15-21LF24-B	1 1/2" O.D.	15,000	LF24	15/16"	5"	2 1/2"	2 7/16"	1"

## Caps

Tubing end caps are offered for use in sealing off tubing ends either for temporary use or permanent use, such as on small volume reservoirs. Standard material is high tensile 316 stainless steel. Standard tubing collars and glands are provided unless otherwise specified.

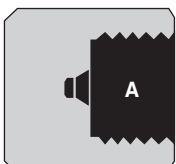

Catalog No.	Tubing	psi	A	Length	Hex
20-21LF4-C	1/4" O.D.	20,000	LF4	7/8"	5/8"
20-21LF6-C	3/8" O.D.	20,000	LF6	1 3/8"	3/4"
20-21LF9-C	9/16" O.D.	20,000	LF9	1 1/2"	1"
20-21LF12-C	3/4" O.D.	20,000	LF12	2 1/2"	1 3/8"
20-21LF16-C	1" O.D.	20,000	LF16	3"	1 3/4"
15-21LF24-C	1 1/2" O.D.	15,000	LF24	3 1/2"	2 1/4"

# Medium Pressure Valves

## Line Filters

The line filters as shown utilize sintered stainless steel filter discs 4 pc./set. Porosities are available as per the chart to the right. If not otherwise specified, 100 micron filter discs are supplied. (One micron = 0.001 millimeters). Material of body, caps and cover is high tensile 316 stainless steel. Standard tubing glands and collars are provided unless otherwise specified.

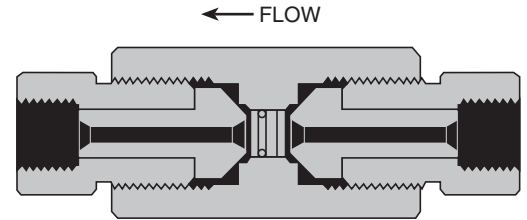

Catalog No.	Tubing	psi	Connections	Orifice	Length	Thickness	Micron Size Filter Available					
							0.5	2	5	10	40	100
20-51LF4	1/4" O.D.	20,000	LF4	1/8"	5 1/4"	1 3/8"	●	●	●	●	●	●
20-51LF6	3/8" O.D.	20,000	LF6	7/32"	5 23/64"	1 3/8"	●	●	●	●	●	●
20-51LF9	9/16" O.D.	20,000	LF9	23/64"	5 23/64"	1 3/8"	●	●	●	●	●	●

## Ball Check Valves

Ball type check valves insure flow in one direction only. Material for body, caps and cover is high tensile 316 stainless steel. Standard tubing glands and collars are provided unless otherwise specified.

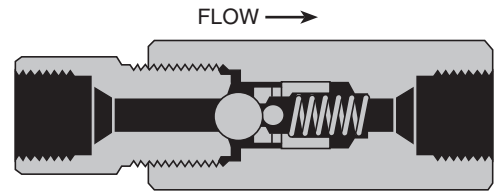

Catalog No.	Tubing	psi	Connections	Orifice	Length	Thickness
20-41LF4	1/4" O.D.	20,000	LF4	1/8"	3 3/4"	1"
20-41LF6	3/8" O.D.	20,000	LF6	7/32"	3 3/4"	1"
20-41LF9	9/16" O.D.	20,000	LF9	23/64"	4 1/2"	1 3/8"
20-41LF12	3/4" O.D.	20,000	LF12	7/16"	5 1/8"	1 3/4"
20-41LF16	1" O.D.	20,000	LF16	9/16"	6 1/2"	2 1/2"

Note: 20-41LF16 material 17-4PH

## Soft Seat Check Valves

Soft seat check valves insure flow in one direction only and can be mounted in any position. These are highly reliable for both gas and liquid service. Standard material for the sealing surface (soft seat) is Buna-N (nitrile) on 1/4", 3/8" and 9/16" models, and Teflon on 3/4" and 1" models, with other materials (including each of these, as well as Viton) available upon request. Temperature is limited by the choice of O-ring material. Material of all other parts is high tensile 316 stainless steel. Standard glands and collars are provided unless otherwise specified.

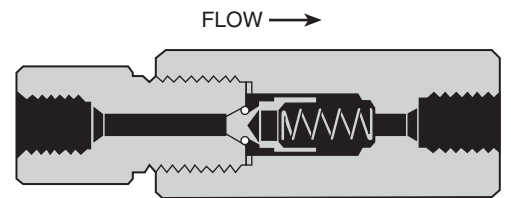

Catalog No.	Tubing	psi	Connections	Orifice	Length	Thickness
20-41LF4-T	1/4" O.D.	20,000	LF4	1/8"	3 3/4"	1"
20-41LF6-T	3/8" O.D.	20,000	LF6	7/32"	3 3/4"	1"
20-41LF9-T	9/16" O.D.	20,000	LF9	23/64"	4 1/2"	1 3/8"
20-41LF12-T	3/4" O.D.	20,000	LF12	7/16"	5 1/8"	1 3/4"
20-41LF16-T	1" O.D.	20,000	LF16	9/16"	6 1/2"	2 1/2"

Note: 20-41LF16 material 17-4PH



## Safety Heads

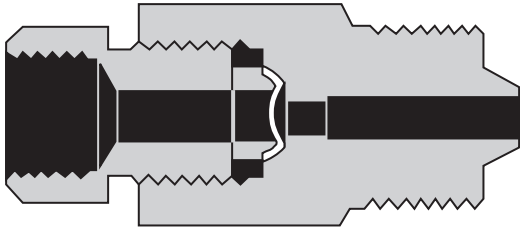

CE marked safety heads are now available, add -CE to end of standard part number. Consult factory for pricing.

The male inlet design can be inserted directly into the tubing connections of valves and various fittings such as tees and crosses, or located in pressure vessels.

Outlet connections are  $\frac{3}{8}$ " pipe (NPT). This outlet may be connected to a suitable discharge line to vent pressure to a safe location in the event of bursting of the rupture disc. Torque required for sealing rupture discs will range from 40 to 90 foot pounds, depending upon pressure and media being used.

Material of body and hold down nut is high tensile 316 stainless steel. Standard tubing glands and collars are provided unless otherwise specified.

**Note:** Rupture discs are **not** included and must be ordered as a separate item.

4

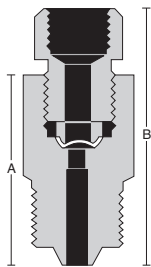

### Male Inlet Safety Heads

Catalog No.	Pressure Rating psi	Inlet Connection	A	B	Hex Size
20-61LM4	20,000	$\frac{1}{4}$ " MEDIUM PRESSURE	2"	3"	1"
20-61LM6	20,000	$\frac{3}{8}$ " MEDIUM PRESSURE	$2\frac{1}{8}$ "	$3\frac{1}{8}$ "	1"
20-61LM9	20,000	$\frac{9}{16}$ " MEDIUM PRESSURE	$2\frac{1}{4}$ "	$3\frac{1}{4}$ "	1"
20-61LM12	20,000	$\frac{3}{4}$ " MEDIUM PRESSURE	$2\frac{1}{2}$ "	$3\frac{1}{2}$ "	$1\frac{1}{4}$ "
20-61LM16	20,000	1" MEDIUM PRESSURE	$3\frac{3}{8}$ "	$4\frac{3}{8}$ "	$1\frac{1}{8}$ "

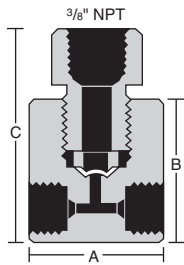

### Tee Type Safety Heads

Catalog No.	Pressure Rating psi	Inlet Connection	A	B	Thickness
20-63LF4	20,000	$\frac{1}{4}$ " MEDIUM PRESSURE	$1\frac{1}{2}$ "	$1\frac{5}{8}$ "	$2\frac{5}{8}$ "
20-63LF6	20,000	$\frac{3}{8}$ " MEDIUM PRESSURE	2"	$1\frac{3}{4}$ "	$2\frac{3}{4}$ "
20-63LF9	20,000	$\frac{9}{16}$ " MEDIUM PRESSURE	$2\frac{1}{2}$ "	2"	3"

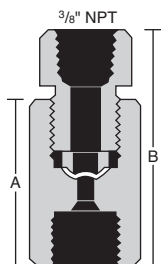

### Female Inlet (Straight) Safety Heads

Catalog No.	Pressure Rating psi	Inlet Connection	A	B	Hex Size
20-61LF4	20,000	$\frac{1}{4}$ " MEDIUM PRESSURE	$1\frac{7}{8}$ "	$2\frac{7}{8}$ "	1"
20-61LF6	20,000	$\frac{3}{8}$ " MEDIUM PRESSURE	2"	3"	1"
20-61LF9	20,000	$\frac{9}{16}$ " MEDIUM PRESSURE	$2\frac{1}{4}$ "	$3\frac{1}{4}$ "	1"

# Medium Pressure Valves

## Rupture Discs

### 1/4" Angled Seat

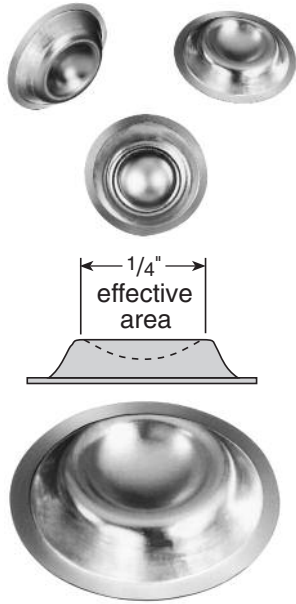

**SPECIAL DISCS** are available on special order for pressure ranges not shown below and in numerous materials and coatings. Consult factory for price and delivery.

Standard rupture discs are available from stock in burst pressures as listed in the chart below. All pressures through 20,000 psi are shaded. These discs are 316 stainless steel (except for 1,000 psi which are inconel) and may be used with any of the safety heads shown. Note that these rupture discs are supplied with a range of plus 6% and minus 3% of specified burst pressure. Samples of each batch are then tested and typically the actual average burst pressure is stamped on an accompanying metal tag. There is a +/- 5% burst tolerance applied after the burst pressure has been established. Factors influencing rupture disc life include corrosion, metal fatigue, and cyclic effects. Periodic replacement is recommended to prevent premature failure.

### Standard Burst Pressures (in psi at 72°F)

1,000	3,000	5,000	7,000	9,000	11,000	17,500	25,000	37,500	55,000
1,500	3,500	5,500	7,500	9,500	11,500	18,000	27,000	40,000	60,000
2,000	4,000	6,000	8,000	10,000	12,500	20,000	30,000	45,000	65,000
2,500	4,500	6,500	8,500	10,500	15,000	22,500	35,000	50,000	

## Anti-Vibration Gland Assemblies

Tubing systems that are subject to extreme vibration or shock, such as mobile pressure systems or long tubing runs culminating at a compressor, will benefit from the use of High Pressure Equipment Company's Anti-Vibration Gland Assemblies. These assemblies utilize the same reliable connection geometries as the standard HiP fittings, with the added benefit of essentially unlimited vibrational fatigue life.

A coned and threaded tube, when subjected to unusual or excessive vibration, may fail prematurely and break at the last thread. The Anti-Vibration Gland Assembly acts to move the fulcrum of vibration away from the threaded portion of the tube and onto the strong, solid wall of the tubing. A wedge-like collet firmly holds the assembly in place, virtually eliminating premature tubing failure while reliably maintaining a leak-free connection between the tube and the connection seat.

4

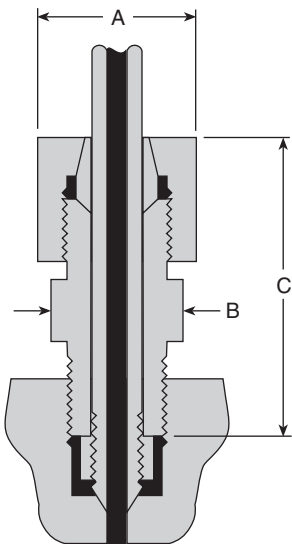

### Medium Pressure Anti-Vibration Gland Assemblies

Catalog No.	Pressure Rating psi	Connections	A	B	C
20-3LM4	20,000	1/4" MEDIUM PRESSURE	5/8"	1/2"	1 7/16"
20-3LM6	20,000	3/8" MEDIUM PRESSURE	3/4"	5/8"	1 5/8"
20-3LM9	20,000	9/16" MEDIUM PRESSURE	1"	7/8"	1 7/8"
20-3LM12	20,000	3/4" MEDIUM PRESSURE	1 1/4"	1 1/8"	2 1/8"
20-3LM16	20,000	1" MEDIUM PRESSURE	1 1/2"	1 3/8"	2 1/2"

### Anti-Vibration Components

Tubing Size	Slotted Collet	Collet Gland	Collet Body	Collar
1/4"	2-8769	2-8770	2-8768	20-2L4
3/8"	2-8772	2-8773	2-8771	20-2L6
9/16"	2-8775	2-8776	2-8774	20-2L9
3/4"	2-8778	2-8779	2-8777	20-2L12
1"	2-8781	2-8782	2-8780	20-2L16

# Medium Pressure Valves

## Medium Pressure Tubing

Tubing is cold drawn, seamless, and is supplied in the  $\frac{1}{8}$  hard condition (not annealed). Tensile strength is approximately 40 percent higher than that of annealed tubing. All tubing is manufactured in strict accordance with High Pressure Equipment Company specifications to insure tolerances and bore quality. Tubing is stocked in lengths of 20 to 24 feet but may be ordered in shorter lengths with **no additional cutting charge**.

	Tubing Size	Working Pressure psi	Wall Thickness	Type of Connection Used	Material	Catalog Order Number
<b>1/4"</b>	1/4" O.D. x 0.109" I.D.	20,000	0.070"	1/4" MEDIUM PRESSURE (LF4)	316 SS	20-9M4-316
<b>3/8"</b>	3/8" O.D. x 0.203" I.D.	20,000	0.086"	3/8" MEDIUM PRESSURE (LF6)	316 SS	20-9M6-316
<b>9/16"</b>	9/16" O.D. x 0.359" I.D.	15,000	0.100"	9/16" MEDIUM PRESSURE (LF9)	316 SS	10-9M9-316
	9/16" O.D. x 0.312" I.D.	20,000	0.124"		304 SS	20-9M9-304
					316 SS	20-9M9-316
<b>3/4"</b>	3/4" O.D. x 0.516" I.D.	15,000	0.117"	3/4" MEDIUM PRESSURE (LF12)	316 SS	10-9M12-316
	3/4" O.D. x 0.438" I.D.	20,000	0.156"			20-9M12-316
<b>1"</b>	1" O.D. x 0.688" I.D.	15,000	0.156"	1" MEDIUM PRESSURE (LF16)	316 SS	10-9M16-316
	1" O.D. x 0.562" I.D.	20,000	0.219"			20-9M16-316
<b>1 1/2"</b>	1 1/2" O.D. x 0.937" I.D.	15,000	0.281"	1 1/2" MEDIUM PRESSURE (LF24)	316 SS	15-9M24-316

## Nipples

Nipples are stocked in 316 stainless steel. Nipples in lengths other than those shown are supplied upon request. Nipples are not furnished with collars and glands, unless specified at time of order.



### Coned and Threaded Nipples

Length ↓	Tubing Size (O.D. x I.D.)							
	1/4" O.D. x 7/64" I.D.	3/8" O.D. x 13/64" I.D.	9/16" O.D. x 5/16" I.D.	3/4" O.D. x 33/64" I.D.	3/4" O.D. x 7/16" I.D.	1" O.D. x 11/16" I.D.	1" O.D. x 9/16" I.D.	1 1/2" O.D. x 15/16" I.D.
psi →	20,000 psi	20,000 psi	20,000 psi	15,000 psi	20,000 psi	15,000 psi	20,000 psi	15,000 psi
2 3/4"	20-LM4-2.75							
3"		20-LM6-3						
4"			20-LM9-4	10-LM12-4				
6"	20-LM4-6	20-LM6-6	20-LM9-6	10-LM12-6	20-LM12-6	10-LM16-6	20-LM16-6	15-LM24-6
8"	20-LM4-8	20-LM6-8	20-LM9-8	10-LM12-8	20-LM12-8	10-LM16-8	20-LM16-8	15-LM24-8
10"	20-LM4-10	20-LM6-10	20-LM9-10	10-LM12-10	20-LM12-10	10-LM16-10	20-LM16-10	15-LM24-10
12"	20-LM4-12	20-LM6-12	20-LM9-12	10-LM12-12	20-LM12-12	10-LM16-12	20-LM16-12	15-LM24-12

## Medium Pressure Connections

The Medium Pressure tubing connection is available for 1/4", 3/8", 9/16", 3/4", and 1" O.D. tubing. The tubing may be prepared with the use of tooling (see Tooling section 15) or prepared at the factory to specified lengths. Additionally, standard length coned and threaded nipples are available from stock (see page 38).

This connection has become an industry standard for use at elevated pressures and temperatures in both liquid and gas applications. It may be disassembled and retightened indefinitely. The threads of the gland are right-hand while the threads of the collar and tubing are left-hand to prevent rotation of the collar during assembly.

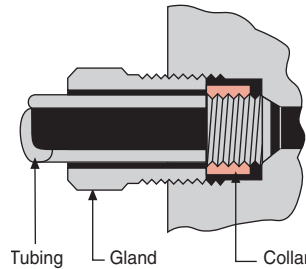

**Materials.** All of the components required for make-up of a Medium Pressure connection (glands, collars and plugs) are produced in Type 316 stainless steel.

**Glands and collars.** All valves and fittings are provided (except nipples) unless otherwise requested. (See chart on the right for size details and catalog numbers).

4

20,000 psi					
LF4 1/4" O.D. Tubing	LF6 3/8" O.D. Tubing	LF9 9/16" O.D. Tubing	LF12 3/4" O.D. Tubing	LF16 1" O.D. Tubing	LF24 1 1/2" O.D. Tubing
<b>Female Opening Detail</b>					
<b>Gland</b>					
<b>Collar</b>					
<b>Plug</b>					
<b>Tube End Prep</b>					





# High Pressure Equipment

## High Pressure Valves, Fittings and Tubing

**30,000, 40,000 and 60,000 psi service**

High Pressure Equipment Company has developed a line of High Pressure products to assure safe and easy plumbing for 30,000, 40,000 and 60,000 psi. These needle valves, fittings, line filters, check valves, safety heads, rupture discs, anti-vibration gland assemblies, tubing and nipples are engineered to the highest standards of repeatable quality. The reliable performance of these products has made HiP one of the world's leading suppliers of elevated pressure components.

High Pressure components use a coned-and-threaded connection which accommodates the high temperatures and pressures common in these applications. High Pressure valves are available in various tubing sizes and with body designs to satisfy widely varied requirements. A line of fittings is available to facilitate adapting to Taper Seal, Medium Pressure, or other High Pressure threaded pipe systems.



### Index

30,000 psi Valves	.41-42
40,000 psi Valves	.43-44
60,000 psi Valves	.45-46
Valve Options	.47
Fittings	.48
Unions, Bulkheads & Caps	.49
Line Filters & Check Valves	.50-51
Rupture Discs	.51
Safety Heads	.52
Anti-Vibration Gland Assemblies	.53
Tubing	.54
Coned & Threaded Nipples	.54
Connection Details	.55



## 30,000 psi High Pressure Valves

**High Pressure (coned & threaded)** type connections for  $\frac{1}{8}$ ",  $\frac{1}{4}$ ",  $\frac{3}{8}$ ",  $\frac{9}{16}$ " and 1" O.D. tubing.

**Non-rotating slotted stems** are standard on HF2, HF4, HF6 and HF9 for on-off service and ensure long life on valve seats. Regulating tip stems are available for all valves at no additional cost, add - REG to part number.

**Glands and collars** for tubing are supplied with each valve unless otherwise requested (glands and collars shown on pages 48 and 55).

**Materials** include high tensile type 316 stainless steel bodies and hardened 17-4PH stainless steel lower section stems.

**Packing** is Teflon (450°F) standard with optional Viton (350°F), BUNA-N (200°F) and Grafoil (800°F) available at no additional cost.

**Air operators** for remote control operation are available for all valves. (Refer to Air Operator section of catalog for additional data).

**Extreme temperatures** can be accommodated using extended stuffing boxes (See Valve Options, page 47). These are available for all sizes except  $\frac{1}{8}$ " tubing.

5

### Valve Features

- Non-rotating slotted stem design (standard for HF2, HF4, HF6 and HF9)
- Packing below stem threads
- Type 316 ss high tensile bodies
- Positive gland lock device
- No stem adjustment needed
- Black T-handles or choice of 4 colors
- Tube sizes  $\frac{1}{8}$ " through 1"

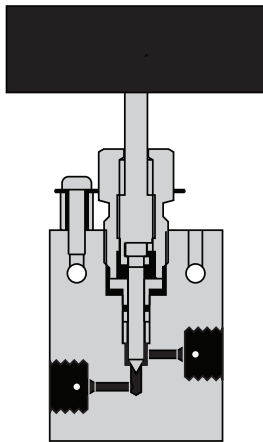

HF2 ( $\frac{1}{8}$ " ) , HF4 ( $\frac{1}{4}$ " ) , HF6 ( $\frac{3}{8}$ " ) and HF9 ( $\frac{9}{16}$ " )

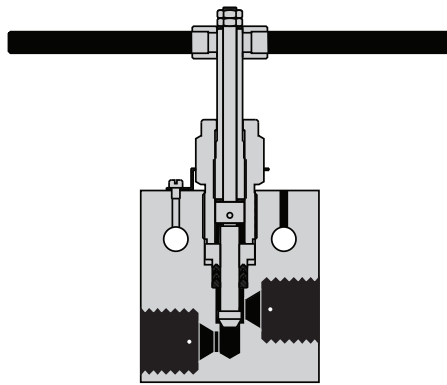

HF16 (1")

# High Pressure Valves

## 30,000 psi Service

### Two Way Straight Valves

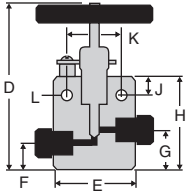

Tubing	Catalog No.	psi	Conn.	Orifice	Cv	D	E	F	G	H	J	K	L	Thickness
1/8" O.D.	30-11HF2	30,000	HF2	1/16"	0.04	3 3/4"	1 1/2"	11/16"	15/16"	1 13/16"	5/16"	7/8"	9/64"	3/4"
1/4" O.D.	30-11HF4	30,000	HF4	3/32"	0.09	5 3/16"	2"	5/8"	1"	2 7/16"	1/2"	1 3/8"	7/32"	1"
3/8" O.D.	30-11HF6	30,000	HF6	1/8"	0.15	5 3/16"	2"	5/8"	1"	2 7/16"	1/2"	1 3/8"	7/32"	1"
9/16" O.D.	30-11HF9	30,000	HF9	1/8"	0.15	5 5/8"	2 5/8"	1"	1 7/16"	2 7/8"	1/2"	1 3/8"	7/32"	1 1/2"
1" O.D.	30-11HF16	30,000	HF16	7/16"	2.29	8 27/64"	4 1/8"	15/16"	1 11/16"	4 7/16"	1 1/8"	2 1/2"	9/16"	1 3/4"

### Two Way Angle Valves

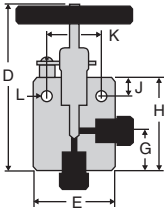

Tubing	Catalog No.	psi	Conn.	Orifice	Cv	D	E	F	G	H	J	K	L	Thickness
1/8" O.D.	30-12HF2	30,000	HF2	1/16"	0.06	3 3/4"	1 1/2"	—	15/16"	1 13/16"	5/16"	7/8"	9/64"	3/4"
1/4" O.D.	30-12HF4	30,000	HF4	3/32"	0.135	5 3/16"	2"	—	1"	2 7/16"	1/2"	1 3/8"	7/32"	1"
3/8" O.D.	30-12HF6	30,000	HF6	1/8"	0.225	5 3/16"	2"	—	1 3/8"	2 13/16"	1/2"	1 3/8"	7/32"	1"
9/16" O.D.	30-12HF9	30,000	HF9	1/8"	0.225	5 5/8"	2 5/8"	—	1 7/16"	2 7/8"	1/2"	1 3/8"	7/32"	1 1/2"
1" O.D.	30-12HF16	30,000	HF16	7/16"	3.435	9 11/32"	4 1/8"	—	2 3/8"	5 1/8"	1 1/8"	2 1/2"	9/16"	1 3/4"

### Three Way Valves / Two Pressure Connections

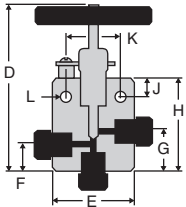

Tubing	Catalog No.	psi	Connection	Orifice	D	E	F	G	H	J	K	L	Thickness
1/8" O.D.	30-13HF2	30,000	HF2	1/16"	3 3/4"	1 1/2"	11/16"	15/16"	1 13/16"	5/16"	7/8"	9/64"	3/4"
1/4" O.D.	30-13HF4	30,000	HF4	3/32"	5 3/16"	2"	5/8"	1"	2 7/16"	1/2"	1 3/8"	7/32"	1"
3/8" O.D.	30-13HF6	30,000	HF6	1/8"	5 3/16"	2"	1"	1 3/8"	2 13/16"	1/2"	1 3/8"	7/32"	1"
9/16" O.D.	30-13HF9	30,000	HF9	1/8"	6 1/16"	2 5/8"	1 7/16"	1 7/8"	3 5/16"	1/2"	1 3/8"	7/32"	1 1/2"
1" O.D.	30-13HF16	30,000	HF16	7/16"	9 23/32"	4 1/8"	2 5/8"	2 13/16"	5 1/16"	1 1/8"	2 1/2"	9/16"	1 3/4"

### Three Way Valves / One Pressure Connection

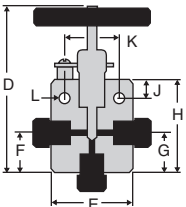

Tubing	Catalog No.	psi	Connection	Orifice	D	E	F	G	H	J	K	L	Thickness
1/8" O.D.	30-14HF2	30,000	HF2	1/16"	3 3/4"	1 1/2"	15/16"	15/16"	1 13/16"	5/16"	7/8"	9/64"	3/4"
1/4" O.D.	30-14HF4	30,000	HF4	3/32"	5 3/16"	2"	1"	1"	2 7/16"	1/2"	1 3/8"	7/32"	1"
3/8" O.D.	30-14HF6	30,000	HF6	1/8"	5 3/16"	2"	2"	1 7/16"	2 13/16"	1/2"	1 3/8"	7/32"	1"
9/16" O.D.	30-14HF9	30,000	HF9	1/8"	5 5/8"	2 5/8"	2 3/16"	1 7/16"	2 7/8"	1/2"	1 3/8"	7/32"	1 1/2"
1" O.D.	30-14HF16	30,000	HF16	7/16"	9 11/32"	4 1/8"	2 5/8"	2 3/8"	5 1/8"	1 1/8"	2 1/2"	9/16"	1 3/4"

### Three Way / Two Stem Connection Valves

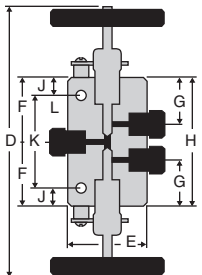

Tubing	Catalog No.	psi	Connection	Orifice	D	E	F	G	H	J	K	L	Thickness
1/8" O.D.	30-15HF2	30,000	HF2	1/16"	5 1/4"	1 1/2"	15/16"	7/8"	2 1/2"	5/16"	1 7/8"	9/64"	3/4"
1/4" O.D.	30-15HF4	30,000	HF4	3/32"	9 1/4"	2"	1"	1 7/16"	3 3/4"	1/2"	2 3/4"	7/32"	1"
3/8" O.D.	30-15HF6	30,000	HF6	1/8"	9 1/2"	2"	2"	1 7/16"	4"	1/2"	3"	7/32"	1"
9/16" O.D.	30-15HF9	30,000	HF9	1/8"	9 7/8"	2 5/8"	2 3/16"	1 7/16"	4 3/8"	1/2"	3 3/8"	7/32"	1 1/2"
1" O.D.	30-15HF16	30,000	HF16	7/16"	11 13/16"	4 1/8"	3 3/8"	2 3/4"	7 3/4"	1 1/8"	2 1/2"	9/16"	1 3/4"

### Replaceable Seat Valves

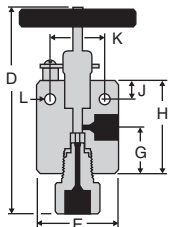

Tubing	Catalog No.	psi	Connection	Orifice	D	E	F	G	H	J	K	L	Thickness
1/4" O.D.	30-12HF4-R	30,000	HF4	3/32"	6"	2"	—	1"	2 7/16"	1/2"	1 3/8"	7/32"	1"
3/8" O.D.	30-12HF6-R	30,000	HF6	1/8"	6 5/8"	2"	—	1 3/8"	2 13/16"	1/2"	1 3/8"	7/32"	1"
9/16" O.D.	30-12HF9-R	30,000	HF9	1/8"	6 13/16"	2 5/8"	—	1 7/16"	2 7/8"	1/2"	1 3/8"	7/32"	1 1/2"
1" O.D.	30-12HF16-R	30,000	HF16	7/16"	10 7/8"	4 1/8"	—	2 3/8"	5 1/8"	1 1/8"	2 1/2"	9/16"	1 3/4"



## 40,000 psi High Pressure Valves

**High Pressure (coned & threaded)** type connections for  $\frac{9}{16}$ " O.D. tubing.

**Non-rotating slotted stems** are standard on HF2, HF4, HF6 and HF9 for on-off service and ensure long life on valve seats. Regulating tip stems are available for all valves at no additional cost, add - REG to part number.

**Glands and collars** for tubing are supplied with each valve unless otherwise requested (glands and collars shown on pages 48 and 55).

**Materials** include high tensile type 316 stainless steel bodies and hardened 17-4PH stainless steel lower section stems.

**Packing set** consists of multiple Teflon packing with nylon back up, with optional Viton (350°F), BUNA-N (200°F) and Grafoil (800°F) available at no additional cost.

**Air operators** for remote control operation are available for all valves. (Refer to Air Operator section of catalog for additional data).

5

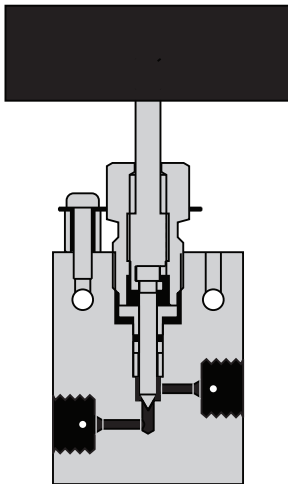

### Valve Features

- Non-rotating slotted stem design (standard for HF2, HF4, HF6 and HF9)
- Packing below stem threads
- Type 316 ss high tensile bodies
- Positive gland lock device
- No stem adjustment needed
- Black T-handles or choice of 4 colors

# High Pressure Valves

## 40,000 psi Service

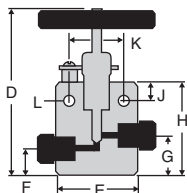

### Two Way Straight Valves

Tubing	Catalog No.	psi	Conn.	Orifice	Cv	D	E	F	G	H	J	K	L	Thickness
9/16" O.D.	40-11HF9	40,000	HF9	1/8"	0.15	5 5/8"	2 5/8"	1"	1 7/16"	2 7/8"	1/2"	1 5/8"	7/32"	1 1/2"

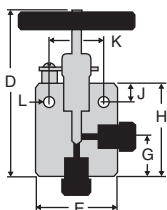

### Two Way Angle Valves

Tubing	Catalog No.	psi	Conn.	Orifice	Cv	D	E	F	G	H	J	K	L	Thickness
9/16" O.D.	40-12HF9	40,000	HF9	1/8"	0.225	5 5/8"	2 5/8"	—	1 7/16"	2 7/8"	1/2"	1 5/8"	7/32"	1 1/2"

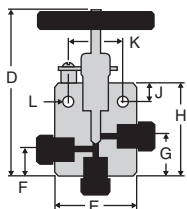

### Three Way Valves / Two Pressure Connections

Tubing	Catalog No.	psi	Connection	Orifice	D	E	F	G	H	J	K	L	Thickness
9/16" O.D.	40-13HF9	40,000	HF9	1/8"	6 1/16"	2 5/8"	1 7/16"	1 7/8"	3 5/16"	1/2"	1 5/8"	7/32"	1 1/2"

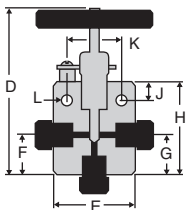

### Three Way Valves / One Pressure Connection

Tubing	Catalog No.	psi	Connection	Orifice	D	E	F	G	H	J	K	L	Thickness
9/16" O.D.	40-14HF9	40,000	HF9	1/8"	5 5/8"	2 5/8"	1 7/16"	1 7/16"	2 7/8"	1/2"	1 5/8"	7/32"	1 1/2"

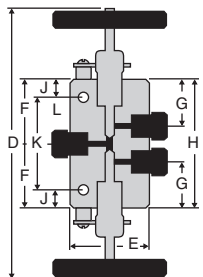

### Three Way / Two Stem Connection Valves

Tubing	Catalog No.	psi	Connection	Orifice	D	E	F	G	H	J	K	L	Thickness
9/16" O.D.	40-15HF9	40,000	HF9	1/8"	9 7/8"	2 5/8"	2 3/16"	1 7/16"	4 3/8"	1/2"	3 3/8"	7/32"	1 1/2"

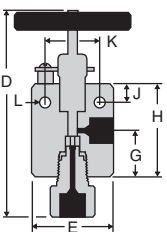

### Replaceable Seat Valves

Tubing	Catalog No.	psi	Connection	Orifice	D	E	F	G	H	J	K	L	Thickness
9/16" O.D.	40-12HF9-R	40,000	HF9	1/8"	6 3/8"	2 5/8"	—	1 7/16"	2 7/8"	1/2"	1 5/8"	7/32"	1 1/2"





## 60,000 psi High Pressure Valves

**High Pressure (coned & threaded)** type connections for  $\frac{1}{8}$ ",  $\frac{1}{4}$ ",  $\frac{3}{8}$ ",  $\frac{9}{16}$ " and 1" O.D. tubing.

**Non-rotating slotted stems** are standard on HF2, HF4, HF6 and HF9 for on-off service and ensure long life on valve seats. Regulating tip stems are available for all valves at no additional cost, add - REG to part number.

**Glands and collars** for tubing are supplied with each valve unless otherwise requested (glands and collars shown on pages 48 and 55).

**Materials** include high tensile type 316 stainless steel bodies and hardened 17-4PH stainless steel lower section stems.

**Packing set** consists of multiple Teflon packing with nylon back up, with optional Viton (350°F), BUNA-N (200°F) and Grafoil (800°F) available at no additional cost.

**Air operators** for remote control operation are available for all valves. (Refer to Air Operator section of the catalog for additional data).

**Extreme temperatures** can be accommodated using extended stuffing boxes (See Valve Options, page 47).

5

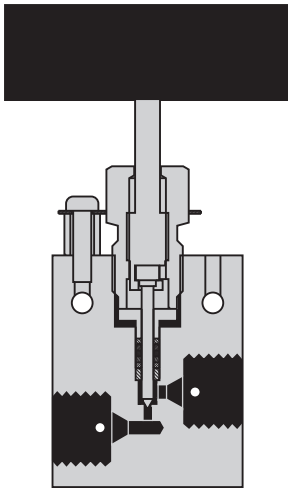

### Valve Features

- Non-rotating slotted stem design (standard for HF2, HF4, HF6 and HF9)
- Packing below stem threads
- Type 316 ss high tensile bodies
- Positive gland lock device
- No stem adjustment needed
- Black T-handles or choice of 4 colors
- Tube sizes  $\frac{1}{8}$ " through  $\frac{9}{16}$ "

# High Pressure Valves

## 60,000 psi Service

### Two Way Straight Valves

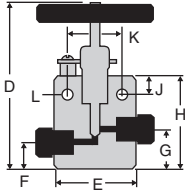

Tubing	Catalog No.	psi	Conn.	Orifice	Cv	D	E	F	G	H	J	K	L	Thickness
1/8" O.D.	60-11HF2	60,000	HF2	1/16"	0.04	5 3/16"	2"	5/8"	15/16"	2 7/16"	1/2"	1 3/8"	7/32"	1"
1/4" O.D.	60-11HF4	60,000	HF4	1/16"	0.04	5 3/16"	2"	5/8"	1"	2 7/16"	1/2"	1 3/8"	7/32"	1"
3/8" O.D.	60-11HF6	60,000	HF6	1/16"	0.04	5 3/16"	2"	5/8"	1"	2 7/16"	1/2"	1 3/8"	7/32"	1"
9/16" O.D.	60-11HF9	60,000	HF9	1/16"	0.04	5 5/8"	2 5/8"	1"	1 7/16"	2 7/8"	1/2"	1 3/8"	7/32"	1 1/2"

### Two Way Angle Valves

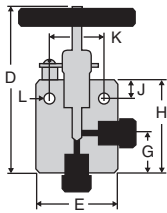

Tubing	Catalog No.	psi	Conn.	Orifice	Cv	D	E	F	G	H	J	K	L	Thickness
1/8" O.D.	60-12HF2	60,000	HF2	1/16"	0.06	5 3/16"	2"	—	1"	2 7/16"	1/2"	1 3/8"	7/32"	1"
1/4" O.D.	60-12HF4	60,000	HF4	1/16"	0.06	5 3/16"	2"	—	1"	2 7/16"	1/2"	1 3/8"	7/32"	1"
3/8" O.D.	60-12HF6	60,000	HF6	1/16"	0.06	5 3/16"	2"	—	1 3/8"	2 13/16"	1/2"	1 3/8"	7/32"	1"
9/16" O.D.	60-12HF9	60,000	HF9	1/16"	0.06	5 5/8"	2 5/8"	—	1 7/16"	2 7/8"	1/2"	1 3/8"	7/32"	1 1/2"

### Three Way Valves / Two Pressure Connections

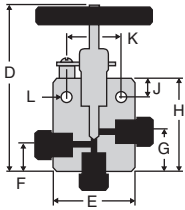

Tubing	Catalog No.	psi	Connection	Orifice	D	E	F	G	H	J	K	L	Thickness
1/8" O.D.	60-13HF2	60,000	HF2	1/16"	5 3/16"	2"	5/8"	1"	2 7/16"	1/2"	1 3/8"	7/32"	1"
1/4" O.D.	60-13HF4	60,000	HF4	1/16"	5 3/16"	2"	5/8"	1"	2 7/16"	1/2"	1 3/8"	7/32"	1"
3/8" O.D.	60-13HF6	60,000	HF6	1/16"	5 3/16"	2"	1"	1 3/8"	2 13/16"	1/2"	1 3/8"	7/32"	1"
9/16" O.D.	60-13HF9	60,000	HF9	1/16"	6 1/16"	2 5/8"	1 7/16"	1 7/16"	3 5/16"	1/2"	1 3/8"	7/32"	1 1/2"

### Three Way Valves / One Pressure Connection

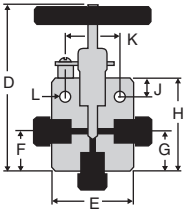

Tubing	Catalog No.	psi	Connection	Orifice	D	E	F	G	H	J	K	L	Thickness
1/8" O.D.	60-14HF2	60,000	HF2	1/16"	5 3/16"	2"	7/8"	1/2"	2 7/16"	1/2"	1 3/8"	7/32"	1"
1/4" O.D.	60-14HF4	60,000	HF4	1/16"	5 3/16"	2"	1"	1"	2 7/16"	1/2"	1 3/8"	7/32"	1"
3/8" O.D.	60-14HF6	60,000	HF6	1/16"	5 3/16"	2"	1 3/8"	1 3/8"	2 13/16"	1/2"	1 3/8"	7/32"	1"
9/16" O.D.	60-14HF9	60,000	HF9	1/16"	5 5/8"	2 5/8"	1 7/16"	1 7/16"	2 7/8"	1/2"	1 3/8"	7/32"	1 1/2"

### Three Way / Two Stem Connection Valves

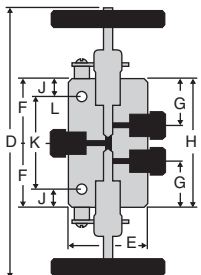

Tubing	Catalog No.	psi	Connection	Orifice	D	E	F	G	H	J	K	L	Thickness
1/8" O.D.	60-15HF2	60,000	HF2	1/16"	9 1/4"	2"	1 7/8"	1 7/16"	3 3/4"	1/2"	2 3/4"	7/32"	1"
1/4" O.D.	60-15HF4	60,000	HF4	1/16"	9 1/4"	2"	1 7/8"	1 7/16"	3 3/4"	1/2"	2 3/4"	7/32"	1"
3/8" O.D.	60-15HF6	60,000	HF6	1/16"	9 1/2"	2"	2"	1 7/16"	4"	1/2"	3"	7/32"	1"
9/16" O.D.	60-15HF9	60,000	HF9	1/16"	9 7/8"	2 5/8"	2 3/16"	1 7/16"	4 3/8"	1/2"	3 3/8"	7/32"	1 1/2"

### Replaceable Seat Valves

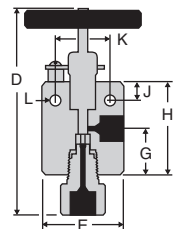

Tubing	Catalog No.	psi	Connection	Orifice	D	E	F	G	H	J	K	L	Thickness
1/4" O.D.	60-12HF4-R	60,000	HF4	1/16"	6"	2"	—	1"	2 7/16"	1/2"	1 3/8"	7/32"	1"
3/8" O.D.	60-12HF6-R	60,000	HF6	1/16"	6 5/8"	2"	—	1 3/8"	2 13/16"	1/2"	1 3/8"	7/32"	1"
9/16" O.D.	60-12HF9-R	60,000	HF9	1/16"	6 13/16"	2 5/8"	—	1 7/16"	2 7/8"	1/2"	1 3/8"	7/32"	1 1/2"

# Valve Options

## Extreme Temperature Valves

The Extreme Temperature Extension provides a means to move the packing area (stuffing box) away from the hot or cold zone of a valve. Fins are provided around the packing area to dissipate heat or cold with this option.

**Size range.** Extreme temperature extensions are available for 1/4" O.D., 3/8" O.D., 9/16" O.D., 3/4" O.D. and 1" O.D. tubing size valves in the 30,000 psi, 60,000 psi series valves.

**Materials and features.** Standard packing is Grafoil and Teflon. Nonrotating tip stems prevent galling at the seats and minimize torque requirements for positive shut off.

**When ordering,** simply add the suffix "-HT" or "-LT" to the standard valve catalog number (example: 30-11HF4-HT).

Temperature ratings of valves with this option, for low temperature (-LT) is -423°F (-252°C) and for high temperature (-HT) is 1200°F (649°C)

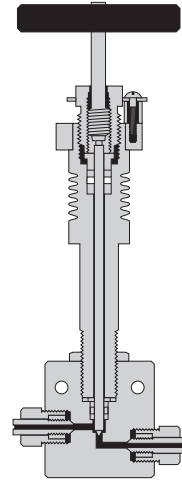

## Micro Control Metering Valves

The Micro Control Metering Valve assembly is available for 1/4", 3/8", 9/16" in 30,000 psi and 60,000 psi valves in this section. This unique stem design operates on the principle of a right-hand threaded component operating in an opposite direction of motion to a left-hand threaded component.

As the pitch sizes of these threads are different from each other, a very fine and precise stem travel is made possible. This provides exceptional control that is not possible with ordinary fine pitched stem designs.

Each complete revolution of the stem provides 0.005" stem travel. The vernier indicator allows readings in increments of one-tenth of a revolution (0.0005" stem travel).

**The non-rotating lower section stem** is ground to a 9 degree included angle to insure maximum control. **While this valve may be turned to the fully off (closed) position, it is always preferable to provide a separate on-off valve in the system to protect the precise control of the metering valve.**

**When ordering,** simply specify the valve catalog number from the valve series and add the suffix "-V" (example: 60-11HF4-V)

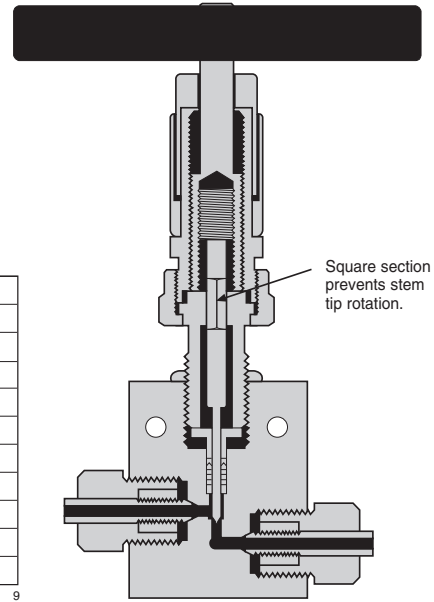
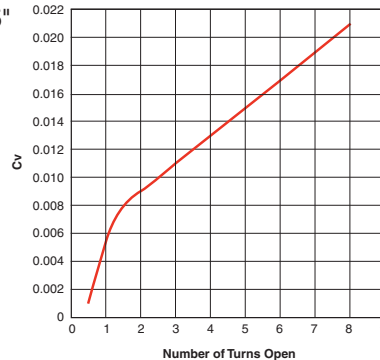

5

## Special Materials

A large number of the valves and fittings shown within this catalog section are frequently furnished in special materials to meet the requirements of specific applications. One of the most commonly requested "special" materials is Hastelloy C-276.

**Tubing collars and glands** for High Pressure coned-and-threaded connections are "non-wetted" parts which do not normally come into contact with the fluid or gas. Thus these items are supplied in 316 stainless steel unless otherwise specified.

**Packing material** in all special material valves is Teflon unless otherwise specified.

**Other materials.** In addition to Hastelloy C-276, valves and fittings can be furnished in Monel, Inconel and titanium. Consult factory for price and delivery.

## Packing Options

### 30,000 psi

Material	Part Number		
	HF2	HF4/HF6/HF9	HF16
Teflon*	B-195	B-181	208741 Set
Grafoil	B-1379	B-1417	B-1455 Set <sup>3</sup>
Buna-N	B-101	B-102	—
Viton	B-614	B-849	—
Silicone	B-149	B-147	—
Polypak	—	—	B-1431 (1) <sup>3</sup>

### 60,000 psi



Material	Part Number
	HF2/HF4/HF6/HF9
Teflon/Nylon**	209689
Grafoil	B-1379
TFE/Viton	212401

# High Pressure Valves

## Glands/Sleeves/Plugs/Elbows/Tees/Crosses

A complete range of elbows, tees, and crosses is available for all of the tubing connection sizes. Material is high tensile 316 stainless steel. Standard tubing glands and collars are provided unless otherwise specified.

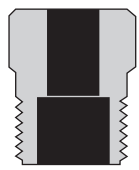
### Connection Components

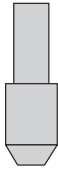
Catalog No.	Tube Size	Gland	Catalog No.	Tube Size	Collar	Catalog No.	Tube Size	Plug
60-2HM2	1/8"		60-2H2	1/8"		60-7HM2	1/8"	
60-2HM4	1/4"		60-2H4	1/4"		60-7HM4	1/4"	
60-2HM6	3/8"		60-2H6	3/8"		60-7HM6	3/8"	
60-2HM9	9/16"		60-2H9	9/16"		60-7HM9	9/16"	
30-2HM16	1"		30-2H16	1"		40-7HM9	9/16"	
				30-7HM16	1"			

### High Pressure Elbows

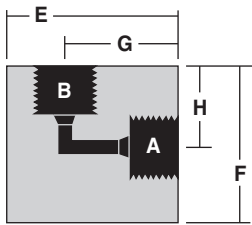

Catalog No.	Pressure Rating psi	Connections	A-B	E	F	G	H	Thickness
60-22HF2	60,000	1/8" O.D. TUBE	HF2	1 1/8"	1 1/8"	3/4"	3/4"	3/4"
60-22HF4	60,000	1/4" O.D. TUBE	HF4	1 3/8"	1 1/2"	7/8"	1"	1"
60-22HF6	60,000	3/8" O.D. TUBE	HF6	1 3/4"	1 1/2"	1 1/4"	1"	1"
60-22HF9	60,000	9/16" O.D. TUBE	HF9	2 5/8"	1 7/8"	1 7/8"	1 1/8"	1 1/2"
40-22HF9	40,000	9/16" O.D. TUBE	HF9	2 5/8"	1 7/8"	1 7/8"	1 1/8"	1 1/2"
30-22HF16	30,000	1" O.D. TUBE	HF16	3"	3"	2 1/16"	2 1/16"	1 3/4"

### High Pressure Tees

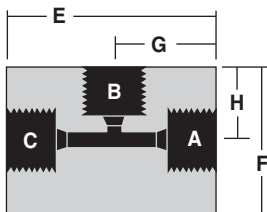

Catalog No.	Pressure Rating psi	Connections	A-B-C	E	F	G	H	Thickness
60-23HF2	60,000	1/8" O.D. TUBE	HF2	1 1/2"	1 1/8"	3/4"	3/4"	3/4"
60-23HF4	60,000	1/4" O.D. TUBE	HF4	2"	1 3/8"	1"	7/8"	1"
60-23HF6	60,000	3/8" O.D. TUBE	HF6	2"	1 9/16"	1"	1 1/16"	1"
60-23HF9	60,000	9/16" O.D. TUBE	HF9	2 5/8"	2 1/8"	1 5/16"	1 3/8"	1 1/2"
40-23HF9	40,000	9/16" O.D. TUBE	HF9	2 5/8"	2 1/8"	1 5/16"	1 3/8"	1 1/2"
30-23HF16	30,000	1" O.D. TUBE	HF16	4 1/8"	3"	2 1/16"	2 1/16"	1 3/4"

### High Pressure Crosses

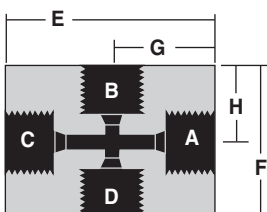

Catalog No.	Pressure Rating psi	Connections	A-B-C-D	E	F	G	H	Thickness
60-24HF2	60,000	1/8" O.D. TUBE	HF2	1 1/2"	1 1/2"	3/4"	3/4"	3/4"
60-24HF4	60,000	1/4" O.D. TUBE	HF4	2"	1 1/2"	1"	3/4"	1"
60-24HF6	60,000	3/8" O.D. TUBE	HF6	2 1/8"	2"	1 1/16"	1"	1"
60-24HF9	60,000	9/16" O.D. TUBE	HF9	2 3/4"	2 5/8"	1 3/8"	1 5/16"	1 1/2"
40-24HF9	40,000	9/16" O.D. TUBE	HF9	2 3/4"	2 5/8"	1 3/8"	1 5/16"	1 1/2"
30-24HF16	30,000	1" O.D. TUBE	HF16	4 1/8"	4 1/8"	2 1/16"	2 1/16"	1 3/4"

## Union Couplings (Slip Type)

Union (slip type) couplings are ideal for use in confined space installations. This design allows the entire coupling to be disconnected and slipped back over the tubing to facilitate assembly and disassembly. In installations where tubing is easily assembled, it is preferable (and less expensive) to use standard straight couplings (see accessories section). Standard material is high tensile 316 stainless steel. Standard tubing collars and glands are provided unless otherwise specified.

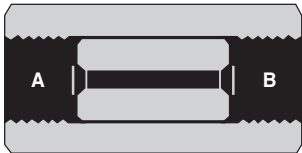

Catalog No.	Pressure Rating psi	Connections	A	B	Length	Hex Size
60-21HF2-U	60,000	1/8" O.D. TUBING	HF2	HF2	1 1/8"	3/4"
60-21HF4-U	60,000	1/4" O.D. TUBING	HF4	HF4	1 3/4"	1"
60-21HF6-U	60,000	3/8" O.D. TUBING	HF6	HF6	2"	1"
60-21HF9-U	60,000	9/16" O.D. TUBING	HF9	HF9	2 3/8"	1 3/8"
40-21HF9-U	40,000	9/16" O.D. TUBING	HF9	HF9	2 3/8"	1 3/8"
30-21HF16-U	30,000	1" O.D. TUBING	HF16	HF16	3 1/2"	1 3/4"

5

## Bulkhead Couplings

Bulkhead couplings are designed specifically for passing a tubing connection through a panel or steel barricade. These couplings include a locknut as shown. Material is high tensile 316 stainless steel. Standard tubing collars and glands are included unless otherwise specified.

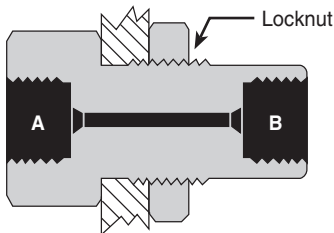

Catalog No.	Pressure Rating psi	Connections	Panel Hole	A	B	Length	Hex Size	Outside Thread
60-21HF2-B	60,000	1/8" O.D. TUBING	15/16"	HF2	HF2	1 13/16"	1"	7/8" - 14
60-21HF4-B	60,000	1/4" O.D. TUBING	15/16"	HF4	HF4	2"	1"	7/8" - 14
60-21HF6-B	60,000	3/8" O.D. TUBING	1 1/8"	HF6	HF6	2 3/8"	1 3/8"	1 1/16" - 12
60-21HF9-B	60,000	9/16" O.D. TUBING	1 11/16"	HF9	HF9	2 3/4"	1 7/8"	1 5/8" - 12
40-21HF9-B	40,000	9/16" O.D. TUBING	1 11/16"	HF9	HF9	2 3/4"	1 7/8"	1 5/8" - 12
30-21HF16-B	30,000	1" O.D. TUBING	1 15/16"	HF16	HF16	3 1/2"	2 1/8"	2 1/8" - 12

## Caps

Tubing end caps are offered for use in sealing off tubing ends either for temporary use or permanent use such as on small volume reservoirs. Standard material is high tensile 316 stainless steel. Standard tubing collars and glands are provided unless otherwise specified.

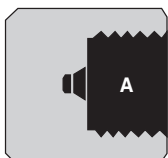

Catalog No.	Pressure Rating psi	Connections	A	Length	Hex Size
60-21HF2-C	60,000	1/8" O.D. TUBING	HF2	7/8"	3/4"
60-21HF4-C	60,000	1/4" O.D. TUBING	HF4	7/8"	3/4"
60-21HF6-C	60,000	3/8" O.D. TUBING	HF6	1 1/4"	1"
60-21HF9-C	60,000	9/16" O.D. TUBING	HF9	1 1/2"	1 3/8"
40-21HF9-C	40,000	9/16" O.D. TUBING	HF9	1 1/2"	1 3/8"
30-21HF16-C	30,000	1" O.D. TUBING	HF16	3"	1 3/4"

# High Pressure Valves

## Line Filters

The line filters as shown utilize sintered stainless steel filter discs 3 pc./set. Porosities are available as per the chart to the right. If not otherwise specified, 100 micron filter discs are supplied. (One micron = 0.001 millimeters). Material of bodies and end covers is high tensile 316 stainless steel. Standard tubing glands and collars are provided unless otherwise specified.

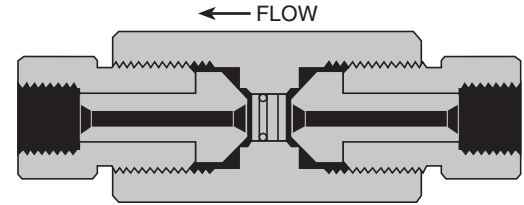

Catalog No.	Pressure Rating psi	Connections	Length	Hex Size	Micron Size Filter Available					
					0.5	2	5	10	40	100
40F-51HF9	40,000	9/16" HIGH PRESSURE	5 3/4"	1 1/2"	●	●	●	●	●	●
60F-51HF2	60,000	1/8" HIGH PRESSURE	4 11/16"	1 1/2"	●	●	●	●	●	●
60F-51HF4	60,000	1/4" HIGH PRESSURE	4 7/8"	1 1/2"	●	●	●	●	●	●
60F-51HF6	60,000	3/8" HIGH PRESSURE	5 1/4"	1 1/2"	●	●	●	●	●	●
60F-51HF9	60,000	9/16" HIGH PRESSURE	5 3/4"	1 1/2"	●	●	●	●	●	●

## Ball Check Valves

Ball type check valves insure flow in one direction only. Material for bodies and covers is 316 stainless steel (30-41HF16 body and cover are 17-4PH). Standard tubing glands and collars are provided unless otherwise specified.

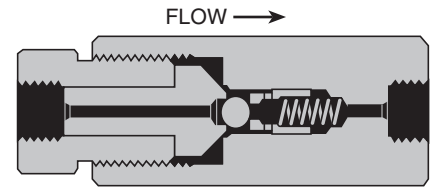

Catalog No.	psi	Connections	Length	Hex
40-41HF9	40,000	9/16" HIGH PRESSURE	5 1/8"	1 1/2"
60-41HF2	60,000	1/8" HIGH PRESSURE	4 3/16"	1 1/2"
60-41HF4	60,000	1/4" HIGH PRESSURE	4 1/4"	1 1/2"
60-41HF6	60,000	3/8" HIGH PRESSURE	4 5/8"	1 1/2"
60-41HF9	60,000	9/16" HIGH PRESSURE	5 1/8"	1 1/2"
30-41HF16	30,000	1" HIGH PRESSURE	6 1/2"	2 1/2" RD with flats

## Soft Seat Check Valves

Soft seat check valves insure flow in one direction only and can be mounted in any position. These are highly reliable for both gas and liquid service. Standard O-ring (soft seat) material for the sealing surface is Buna-N (nitrile) with other materials including Teflon and Viton available on request. Temperature is limited by the choice of O-ring material.

Material of all other parts is high tensile 316 stainless steel. (30-41HF16-T body and cover are 17-4PH). Standard glands and collars are provided unless otherwise specified.

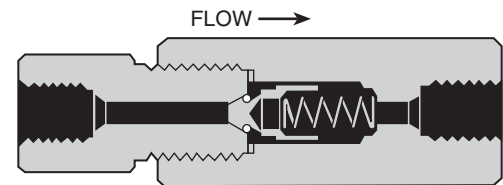

Catalog No.	psi	Connections	Length	Hex
30-41HF2-T	30,000	1/8" HIGH PRESSURE	3 3/4"	1"
30-41HF4-T	30,000	1/4" HIGH PRESSURE	3 7/8"	1"
30-41HF6-T	30,000	3/8" HIGH PRESSURE	3 7/8"	1"
30-41HF9-T	30,000	9/16" HIGH PRESSURE	4 1/4"	1 3/8"
40-41HF9-T	40,000	9/16" HIGH PRESSURE	5 1/16"	1 1/2"
60-41HF4-T	60,000	1/4" HIGH PRESSURE	4 3/16"	1 1/2"
60-41HF6-T	60,000	3/8" HIGH PRESSURE	4 9/16"	1 1/2"
60-41HF9-T	60,000	9/16" HIGH PRESSURE	5 1/16"	1 1/2"
30-41HF16-T	30,000	1" HIGH PRESSURE	6 1/2"	2 1/2" RD with flats



## Excess Surge Check Valves

Excess surge check valves are used to eliminate loss of pressure due to a sudden surge or opening of a pressure component in a pressurized system (such as a breakage of a gauge or test component). These check valves should be mounted in the vertical position. Only one basic size is available (60-41HF9-E) with adapters readily available to convert to other size connections. Standard tubing glands and collars are provided unless otherwise specified.



Catalog No.	psi	Connections	Length	Hex
60-41HF9-E	60,000	$\frac{9}{16}$ " HIGH PRESSURE	3 $\frac{1}{8}$ "	1 $\frac{1}{2}$ "

5

## Rupture Discs $\frac{1}{4}$ " Angled Seat

Standard rupture discs are available from stock in burst pressures as listed in the chart to the right. These discs are 316 stainless steel (except for 1000 psi which are inconel) and may be used with any of the safety heads shown. Note that these rupture discs are supplied with a range of plus 6% and minus 3% of specified burst pressure. Samples of each batch are then tested and typically the actual average burst pressure is stamped on an accompanying metal tag. There is a +/- 5% burst tolerance applied after the burst pressure has been established. Factors influencing rupture disc life include corrosion, metal fatigue, and cyclic effect. Periodic replacement is recommended to prevent premature failure. It is recommended that working pressure does not exceed 70% of burst rating for maximum life cycle of the disc.



**SPECIAL DISCS** are available on special order for pressure ranges not shown below and in numerous materials and coatings. Consult factory for price and delivery.



### Standard Burst Pressures (in psi at 72°F)

1,000	3,000	5,000	7,000	9,000	11,000	17,500	25,000	37,500	55,000
1,500	3,500	5,500	7,500	9,500	11,500	18,000	27,000	40,000	60,000
2,000	4,000	6,000	8,000	10,000	12,500	20,000	30,000	45,000	65,000
2,500	4,500	6,500	8,500	10,500	15,000	22,500	35,000	50,000	

# High Pressure Valves

## Safety Heads

A choice of three safety head designs is available, male inlet, female inlet (straight), and tee type. The male inlet design can be inserted directly into the tubing connections of valves and various fittings such as tees and crosses, or located in pressure vessels.

Outlet connections on all sizes are  $\frac{3}{8}$ " pipe (NPT). This outlet may be connected to a suitable discharge line to vent pressure to a safe location in the event of bursting of the rupture disc. Torque required for sealing rupture discs will range from 40 to 90 foot pounds, depending upon pressure and media being used.

Material of bodies and hold down nuts is high tensile 316 stainless steel. Standard tubing glands and collars are provided unless otherwise specified.

**Note:** Rupture discs are **not** included and must be ordered as a separate item.

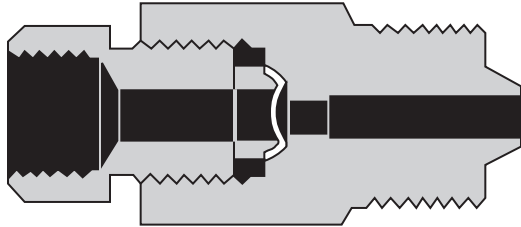

5

CE marked safety heads are now available, add -CE to end of standard part number. Consult factory for pricing.

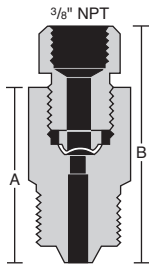

### Male Inlet Safety Heads

Catalog No.	Pressure Rating psi	Inlet Connection	A	B	Hex Size
60-61HM2	60,000	$\frac{1}{8}$ " HIGH PRESSURE	$1\frac{13}{16}$ "	$2\frac{13}{16}$ "	$1\frac{1}{8}$ "
60-61HM4	60,000	$\frac{1}{4}$ " HIGH PRESSURE	$1\frac{7}{8}$ "	$2\frac{7}{8}$ "	$1\frac{1}{8}$ "
60-61HM6	60,000	$\frac{3}{8}$ " HIGH PRESSURE	$2\frac{1}{8}$ "	$3\frac{1}{8}$ "	$1\frac{1}{8}$ "
60-61HM9	60,000	$\frac{9}{16}$ " HIGH PRESSURE	$2\frac{9}{16}$ "	$3\frac{3}{8}$ "	$1\frac{1}{8}$ "
30-61HM16	30,000	1" HIGH PRESSURE	$3\frac{7}{16}$ "	$3\frac{7}{16}$ "	$1\frac{1}{8}$ "

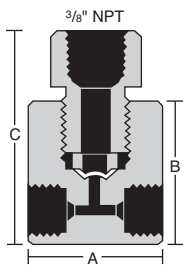

### Tee Type Safety Heads

Catalog No.	Pressure Rating psi	Inlet Connection	A	B	Thickness
60-63HF2	60,000	$\frac{1}{8}$ " HIGH PRESSURE	$1\frac{1}{2}$ "	$1\frac{5}{8}$ "	$2\frac{5}{8}$ "
60-63HF4	60,000	$\frac{1}{4}$ " HIGH PRESSURE	$1\frac{1}{2}$ "	$1\frac{5}{8}$ "	$2\frac{5}{8}$ "
60-63HF6	60,000	$\frac{3}{8}$ " HIGH PRESSURE	2"	$1\frac{3}{4}$ "	$3\frac{3}{4}$ "
60-63HF9	60,000	$\frac{9}{16}$ " HIGH PRESSURE	$2\frac{5}{8}$ "	2"	3"

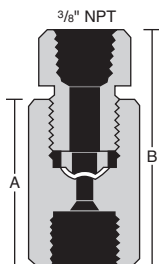

### Female Inlet (Straight) Safety Heads

Catalog No.	Pressure Rating psi	Inlet Connection	A	B	Hex Size
60-61HF2	60,000	$\frac{1}{8}$ " HIGH PRESSURE	$1\frac{7}{8}$ "	$2\frac{7}{8}$ "	$1\frac{1}{8}$ "
60-61HF4	60,000	$\frac{1}{4}$ " HIGH PRESSURE	$1\frac{7}{8}$ "	$2\frac{7}{8}$ "	$1\frac{1}{8}$ "
60-61HF6	60,000	$\frac{3}{8}$ " HIGH PRESSURE	$1\frac{7}{8}$ "	$2\frac{7}{8}$ "	$1\frac{1}{8}$ "
60-61HF9	60,000	$\frac{9}{16}$ " HIGH PRESSURE	$2\frac{7}{8}$ "	$3\frac{7}{8}$ "	$1\frac{1}{2}$ "

## Anti-Vibration Gland Assemblies

Tubing systems that are subject to extreme vibration or shock, such as mobile pressure systems or long tubing runs culminating at a compressor, will benefit from the use of High Pressure Equipment Company's Anti-Vibration Gland Assemblies. These assemblies utilize the same reliable connection geometries as the standard HiP fittings, with the added benefit of essentially unlimited vibrational fatigue life.

A coned and threaded tube, when subjected to unusual or excessive vibration, may fail prematurely and break at the last thread. The Anti-Vibration Gland Assembly acts to move the fulcrum of vibration away from the threaded portion of the tube and onto the strong, solid wall of the tubing. A wedge-like collet firmly holds the assembly in place, virtually eliminating premature tubing failure while reliably maintaining a leak-free connection between the tube and the connection seat.

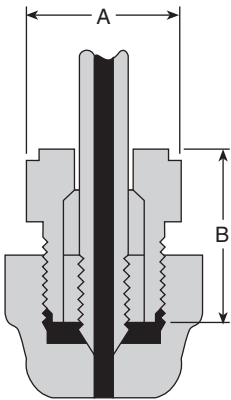

### High Pressure Anti-Vibration Gland Assemblies

Catalog No.	Pressure Rating psi	Connections	A	B
60-3HM4	60,000	1/4" HIGH PRESSURE	5/8"	13/16"
60-3HM6	60,000	3/8" HIGH PRESSURE	13/16"	1 1/8"
60-3HM9	60,000	9/16" HIGH PRESSURE	1 3/16"	1 9/16"
40-3HM9	40,000	9/16" HIGH PRESSURE	1 3/16"	1 9/16"

5

### Anti-Vibration Components

Tubing Size	Slotted Collet	Collet Gland	Collar
1/4"	2-8784	2-8783	60-2H4
3/8"	2-8786	2-8785	60-2H6
9/16"	2-8788	2-8787	60-2H9

# High Pressure Valves

## High Pressure Tubing

Tubing is cold drawn, seamless, and is supplied in the  $\frac{1}{8}$ " hard condition (not annealed). Tensile strength is approximately 40 percent higher than that of annealed tubing. All tubing is manufactured in strict accordance with High Pressure Equipment Company specifications to insure tolerances and bore quality. Tubing is stocked in lengths of 20 to 24 feet but may be ordered in shorter lengths with **no additional cutting charge**.

**Note:** The  $\frac{1}{8}$ " O.D. tubing sizes may be coiled for shipment. Larger sizes must be shipped in straight lengths.

	Tubing Size	Working Pressure psi	Wall Thickness	Type of Connection Used	Material	Catalog Order Number
<b><math>\frac{1}{8}</math>"</b>	$\frac{1}{8}$ " O.D. x 0.020" I.D.	60,000	0.052"	$\frac{1}{8}$ " HIGH PRESSURE (HF2)	316 SS	60-9H2
	$\frac{1}{8}$ " O.D. x 0.040" I.D.	30,000	0.042"	$\frac{1}{8}$ " HIGH PRESSURE (HF2)	316 SS	30-9H2
<b><math>\frac{1}{4}</math>"</b>	$\frac{1}{4}$ " O.D. x 0.083" I.D.	60,000	0.083"	$\frac{1}{4}$ " HIGH PRESSURE (HF4)	316 SS *	60-9H4-316
					304 SS *	60-9H4-304
					HC276	60-9H4-HC276
<b><math>\frac{3}{8}</math>"</b>	$\frac{3}{8}$ " O.D. x $\frac{1}{8}$ " I.D.	60,000	0.125"	$\frac{3}{8}$ " HIGH PRESSURE (HF6)	316 SS	60-9H6-316
					304 SS	60-9H6-304
<b><math>\frac{9}{16}</math>"</b>	$\frac{9}{16}$ " O.D. x $\frac{3}{16}$ " I.D.	60,000	0.154"	$\frac{9}{16}$ " HIGH PRESSURE (HF9)	316 SS	60-9H9-316
					316 SS	60-9H9-316-SGS
					304 SS	60-9H9-304
<b><math>\frac{9}{16}</math>"</b>	$\frac{9}{16}$ " O.D. x $\frac{1}{4}$ " I.D.	40,000	0.155"	$\frac{9}{16}$ " HIGH PRESSURE (HF9)	316 SS	40-9H9-316
					304 SS	40-9H9-304
<b>1"</b>	1" O.D. x 0.437" I.D.	30,000	0.281"	1" HIGH PRESSURE (HF16)	316 SS	30-9H16-316

## Nipples

Nipples as shown below are stocked in Types 304 and 316 Stainless Steel. Nipples in lengths other than those shown are supplied upon request. Nipples are not furnished with collars and glands, unless specified at time of order.



### Coned and Threaded Nipples

Length ↓	Tubing Size (O.D. x I.D.)						
	$\frac{1}{8}$ " x 0.020"	$\frac{1}{8}$ " x 0.040" **	$\frac{1}{4}$ " x 0.083"	$\frac{3}{8}$ " x $\frac{1}{8}$ " *	$\frac{9}{16}$ " x $\frac{1}{4}$ " *	$\frac{9}{16}$ " x $\frac{3}{16}$ " *	1" x 0.437" **
psi →	60,000 psi	30,000 psi	60,000 psi	60,000 psi	40,000 psi	60,000 psi	30,000 psi
2"	60-HM2-2	30-HM2-2					
2 $\frac{3}{4}$ "			60-HM4-2.75				
3"	60-HM2-3	30-HM2-3		60-HM6-3			
4"	60-HM2-4	30-HM2-4			40-HM9-4	60-HM9-4	
6"	60-HM2-6	30-HM2-6	60-HM4-6	60-HM6-6	40-HM9-6	60-HM9-6	30-HM16-6
8"			60-HM4-8	60-HM6-8	40-HM9-8	60-HM9-8	30-HM16-8
9"	60-HM2-9	30-HM2-9					
10"			60-HM4-10	60-HM6-10	40-HM9-10	60-HM9-10	30-HM16-10
12"	60-HM2-12	30-HM2-12	60-HM4-12	60-HM6-12	40-HM9-12	60-HM9-12	30-HM16-12

Specify 316 SS or 304 SS when ordering. \* Also used for 30,000 psi series. \*\* 316 SS

## High Pressure Connections (Coned and Threaded) 30,000/40,000/60,000 psi service

The High Pressure tubing connection is available for 1/8", 1/4", 3/8", 9/16" and 1" O.D. tubing. The tubing may be prepared with the use of tooling (see Tooling section 15) or prepared at the factory to specified lengths. Additionally, standard length coned and threaded tubing nipples are available from stock (see page 54).

This connection has become an industry standard for use at elevated pressures and temperatures in both liquid and gas applications. It may be disassembled and retightened indefinitely.

The threads of the gland are right-hand while the threads of the collar and tubing are left-hand to prevent rotation of the collar during assembly.

### Materials

All of the components required for make-up of a High Pressure connection (glands, collars and plugs) are produced in Type 316 stainless steel.

### Glands and collars.

All valves and fittings are provided (except nipples) unless otherwise requested. (See chart on the right for size details and catalog numbers).

5

30,000 & 60,000 psi						40,000 psi	30,000 psi
HF2 1/8" O.D. Tubing	HF4 1/4" O.D. Tubing	HF6 3/8" O.D. Tubing	HF9 9/16" O.D. Tubing	HF9 9/16" O.D. Tubing	HF16 1" O.D. Tubing		
<b>Female Opening Detail</b>							
HF2	HF4	HF6	HF9	HF9	HF16		
<b>Gland</b>							
60-2HM2	60-2HM4	60-2HM6	60-2HM9	60-2HM9	30-2HM16		
<b>Collar</b>							
60-2H2	60-2H4	60-2H6	60-2H9	60-2H9	30-2H16		
<b>Plug</b>							
60-7HM2	60-7HM4	60-7HM6	60-7HM9	40-7HM9	30-7HM16		
<b>Tube End Prep</b>							
HM2	HM4	HM6	HM9	HM9	HM16		

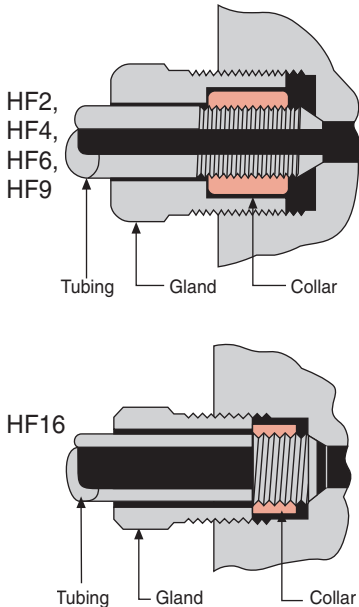



## High Pressure Equipment

---

### **Ultra High Pressure Valves, Fittings and Tubing** **100,000 and 150,000 psi service**

High Pressure Equipment Company has developed a line of Ultra High Pressure products to assure safe and easy plumbing for 100,000 psi and 150,000 psi. These needle valves, fittings, check valves, tubing and nipples are engineered to the highest standards of repeatable quality. The reliable performance of these products has made HiP one of the world's leading suppliers of elevated pressure components.

Ultra High Pressure components use a coned-and-threaded connection which accommodates the extreme conditions found in these applications. Ultra High Pressure valves are available in  $\frac{1}{4}$ " ,  $\frac{3}{8}$ " and  $\frac{9}{16}$ " O.D. tubing sizes and four patterns to satisfy widely varied requirements. A line of fittings is available to facilitate adapting to High Pressure systems.

### **Index**

---

100,000 and 150,000 psi Valves . . .	57-58
Fittings . . . . .	59
Check Valves . . . . .	59
Tubing . . . . .	60
Coned and Threaded Nipples . . . . .	60
Connection Details . . . . .	61







## 100,000 and 150,000 psi Ultra High Pressure Valves

**High Pressure (coned and threaded)** type connections for  $\frac{1}{4}$ ",  $\frac{3}{8}$ " and  $\frac{9}{16}$ " O.D. tubing.

**Non-rotating slotted stems** insure long life on valve seats. Heavy duty "rolled style" stem design is shown below.

**Glands and collars** for tubing are supplied with each valve unless otherwise requested (glands and collars are shown on page 61).

**Materials** include 316 and 17-4 stainless steel for valve bodies with tool steel lower section stems. Valve packing is teflon.

**Corresponding fittings** (elbows, tees, crosses, etc.) are shown on page 59.

**Replaceable Seat Valves** are available for  $\frac{1}{4}$ " O.D. tubing. These valves feature the same body style and body dimensions as the two way angle valves (shown below).

To order add "R" to the corresponding two way valve catalog number (eg. 100-12XF4R).

### Valve Features

- Non-rotating slotted stem design
- Packing below stem threads
- Type 316 ss high tensile bodies
- Positive gland lock device
- No stem adjustment needed
- Black T-handles
- Tube sizes  $\frac{1}{4}$ " through  $\frac{9}{16}$ "

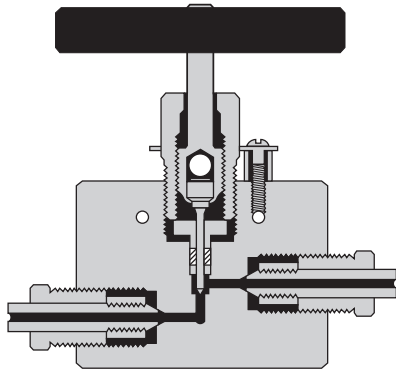

# Ultra High Pressure Valves

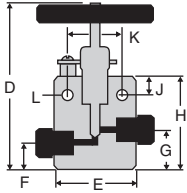

## Two Way Straight Valves

Tubing	Catalog No.	psi	Conn.	Orifice	Cv	D	E	F	G	H	J	K	L	Thickness
1/4" O.D.	100-11XF4	100,000	XF4	1/16"	0.04	5"	2 5/8"	3/4"	1 1/16"	2 1/2"	1/2"	1 5/8"	7/32"	1 1/2"
3/8" O.D.	100-11UF6	100,000	UF6	1/16"	—	5 5/16"	3"	1/2"	1 3/16"	2 1/4"	1/2"	1 5/8"	7/32"	1 1/2"
9/16" O.D.	100-11UF9	100,000	UF9	1/16"	—	4 5/8"	3 1/2"	1"	1 7/16"	2 7/8"	1/2"	1 5/8"	7/32"	1 1/2"
3/8" O.D.	150-11XF6	150,000	XF6	1/16"	0.04	5"	3 1/2"	7/8"	1 3/16"	2 5/8"	1/2"	1 5/8"	7/32"	1 1/2"

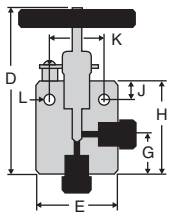

## Two Way Angle Valves

Tubing	Catalog No.	psi	Conn.	Orifice	Cv	D	E	F	G	H	J	K	L	Thickness
1/4" O.D.	100-12XF4	100,000	XF4	1/16"	0.006	5 1/4"	2 5/8"	—	1 5/16"	2 3/4"	1/2"	1 5/8"	7/32"	1 1/2"
3/8" O.D.	100-12UF6	100,000	UF6	1/16"	—	6 1/16"	2 1/4"	—	1 9/16"	3"	1/2"	1 5/8"	7/32"	1 1/2"
9/16" O.D.	100-12UF9	100,000	UF9	1/16"	—	5 3/8"	3 1/2"	—	1 7/16"	3"	1/2"	1 5/8"	7/32"	1 1/2"
3/8" O.D.	150-12XF6	150,000	XF6	1/16"	0.006	5 7/8"	3 1/2"	—	2 1/16"	3 1/2"	1/2"	1 5/8"	7/32"	1 1/2"

6

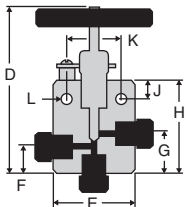

## Three Way Valves / Two Inlets

Tubing	Catalog No.	psi	Connection	Orifice	D	E	F	G	H	J	K	L	Thickness
1/4" O.D.	100-13XF4	100,000	XF4	1/16"	5 1/2"	2 5/8"	1 1/4"	1 9/16"	3"	1/2"	1 5/8"	7/32"	1 1/2"
3/8" O.D.	100-13UF6	100,000	UF6	1/16"	6 5/16"	3"	1 1/2"	1 13/16"	3 1/4"	1/2"	1 5/8"	7/32"	1 1/2"
9/16" O.D.	100-13UF9	100,000	UF9	1/16"	5 3/8"	3 1/2"	1"	1 7/16"	3"	1/2"	1 5/8"	7/32"	1 1/2"
3/8" O.D.	150-13XF6	150,000	XF6	1/16"	5 7/8"	3 1/2"	1 3/4"	2 1/16"	3 1/2"	1/2"	1 5/8"	7/32"	1 1/2"

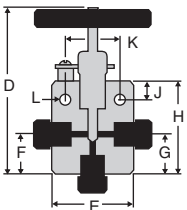

## Three Way Valves / One Inlet

Tubing	Catalog No.	psi	Connection	Orifice	D	E	F	G	H	J	K	L	Thickness
1/4" O.D.	100-14XF4	100,000	XF4	1/16"	5 1/4"	2 5/8"	1 5/16"	1 5/16"	2 3/4"	1/2"	1 5/8"	7/32"	1 1/2"
3/8" O.D.	100-14UF6	100,000	UF6	1/16"	6"	3 1/2"	2 1/16"	2 1/16"	3 1/2"	1/2"	1 5/8"	7/32"	1 1/2"
9/16" O.D.	100-14UF9	100,000	UF9	1/16"	5 3/8"	3 1/2"	1 7/16"	1 7/16"	3"	1/2"	1 5/8"	7/32"	1 1/2"
3/8" O.D.	150-14XF6	150,000	XF6	1/16"	5 7/8"	3 1/2"	2 1/16"	2 1/16"	3 1/2"	1/2"	1 5/8"	7/32"	1 1/2"

## Check Valves/Elbows/Tees/Crosses

We have developed check valves, elbows, tees and crosses for both the 100,000 and 150,000 psi systems. \*Material is high tensile 316 stainless steel. Standard tubing glands and collars are furnished unless otherwise specified.

\* **Note:** Material for 150,000 psi check valve is 17-4. Material for UF6 and UF9 parts is 15-5.

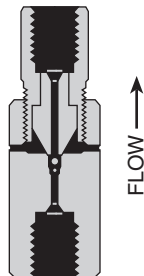

### Ultra High Pressure Check Valves

Catalog No.	psi	Connections	Length	Hex
100-41XF4	100,000	1/4" ULTRA PRESSURE	3 <sup>9</sup> / <sub>16</sub> "	1 <sup>1</sup> / <sub>2</sub> "
100-41UF6	100,000	3/8" ULTRA PRESSURE	4 <sup>1</sup> / <sub>2</sub> "	1 <sup>1</sup> / <sub>2</sub> "
100-41UF9	100,000	9/16" ULTRA PRESSURE	3 <sup>11</sup> / <sub>16</sub> "	1 <sup>7</sup> / <sub>8</sub> "
150-41XF6	150,000	3/8" ULTRA PRESSURE	4 <sup>1</sup> / <sub>2</sub> "	1 <sup>1</sup> / <sub>2</sub> "

**6**

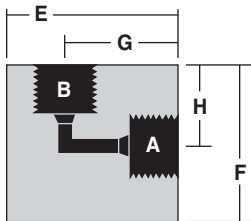

### Ultra High Pressure Elbows

Catalog No.	Pressure Rating psi	Connections	A-B-C-D	E	F	G	H	Thickness
100-22XF4	100,000	1/4" O.D. TUBE	XF4	1 <sup>3</sup> / <sub>4</sub> "	1 <sup>3</sup> / <sub>4</sub> "	1 <sup>1</sup> / <sub>4</sub> "	1 <sup>1</sup> / <sub>4</sub> "	1"
100-22UF6	100,000	3/8" O.D. TUBE	UF6	3"	2 <sup>1</sup> / <sub>8</sub> "	1 <sup>1</sup> / <sub>2</sub> "	1 <sup>1</sup> / <sub>2</sub> "	1 <sup>3</sup> / <sub>8</sub> "
100-22UF9	100,000	9/16" O.D. TUBE	UF9	2 <sup>5</sup> / <sub>8</sub> "	1 <sup>7</sup> / <sub>8</sub> "	1 <sup>7</sup> / <sub>8</sub> "	1 <sup>1</sup> / <sub>8</sub> "	1 <sup>1</sup> / <sub>2</sub> "
150-22XF6	150,000	3/8" O.D. TUBE	XF6	2 <sup>5</sup> / <sub>8</sub> "	2 <sup>5</sup> / <sub>8</sub> "	1 <sup>3</sup> / <sub>4</sub> "	1 <sup>3</sup> / <sub>4</sub> "	1 <sup>1</sup> / <sub>2</sub> "

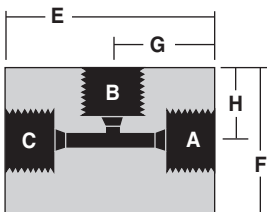

### Ultra High Pressure Tees

Catalog No.	Pressure Rating psi	Connections	A-B-C-D	E	F	G	H	Thickness
100-23XF4	100,000	1/4" O.D. TUBE	XF4	2 <sup>1</sup> / <sub>2</sub> "	1 <sup>3</sup> / <sub>4</sub> "	1 <sup>1</sup> / <sub>4</sub> "	1 <sup>1</sup> / <sub>4</sub> "	1"
100-23UF6	100,000	3/8" O.D. TUBE	UF6	3"	2 <sup>1</sup> / <sub>8</sub> "	1 <sup>1</sup> / <sub>2</sub> "	1 <sup>1</sup> / <sub>2</sub> "	1 <sup>3</sup> / <sub>8</sub> "
100-23UF9	100,000	9/16" O.D. TUBE	UF9	2 <sup>5</sup> / <sub>8</sub> "	2 <sup>1</sup> / <sub>8</sub> "	1 <sup>5</sup> / <sub>16</sub> "	1 <sup>3</sup> / <sub>8</sub> "	1 <sup>1</sup> / <sub>2</sub> "
150-23XF6	150,000	3/8" O.D. TUBE	XF6	3 <sup>1</sup> / <sub>2</sub> "	2 <sup>5</sup> / <sub>8</sub> "	1 <sup>3</sup> / <sub>4</sub> "	1 <sup>3</sup> / <sub>4</sub> "	1 <sup>1</sup> / <sub>2</sub> "

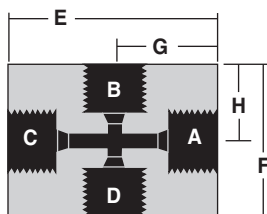

### Ultra High Pressure Crosses

Catalog No.	Pressure Rating psi	Connections	A-B-C-D	E	F	G	H	Thickness
100-24XF4	100,000	1/4" O.D. TUBE	XF4	2 <sup>1</sup> / <sub>2</sub> "	2 <sup>1</sup> / <sub>2</sub> "	1 <sup>1</sup> / <sub>4</sub> "	1 <sup>1</sup> / <sub>4</sub> "	1"
100-24UF6	100,000	3/8" O.D. TUBE	UF6	3"	3"	1 <sup>1</sup> / <sub>2</sub> "	1 <sup>1</sup> / <sub>2</sub> "	1 <sup>3</sup> / <sub>8</sub> "
100-24UF9	100,000	9/16" O.D. TUBE	UF9	2 <sup>5</sup> / <sub>8</sub> "	2 <sup>3</sup> / <sub>4</sub> "	1 <sup>5</sup> / <sub>16</sub> "	1 <sup>3</sup> / <sub>8</sub> "	1 <sup>1</sup> / <sub>2</sub> "
150-24XF6	150,000	3/8" O.D. TUBE	XF6	3 <sup>1</sup> / <sub>2</sub> "	3 <sup>1</sup> / <sub>2</sub> "	1 <sup>3</sup> / <sub>4</sub> "	1 <sup>3</sup> / <sub>4</sub> "	1 <sup>1</sup> / <sub>2</sub> "

# Ultra High Pressure Valves

## Ultra High Pressure Tubing

Tubing is cold drawn, seamless, and is supplied in the  $\frac{1}{8}$  hard condition (not annealed). Tensile strength is approximately 40 percent higher than that of annealed tubing. All tubing is manufactured in strict accordance with High Pressure Equipment Company specifications to insure tolerances and bore quality. Tubing is stocked in lengths of 20 to 24 feet but may be ordered in shorter lengths with **no additional cutting charge**.



6

	Tubing Size	Working Pressure psi	Wall Thickness	Type of Connection Used	Material	Catalog Order Number
$\frac{1}{4}$ "	$\frac{1}{4}$ " O.D. x $\frac{1}{16}$ " I.D.	100,000	0.094"	$\frac{1}{4}$ " ULTRA HIGH PRESSURE (XF4)	316 SS	100-9X4-316
					304 SS	100-9X4-304
$\frac{3}{8}$ "	$\frac{3}{8}$ " O.D. x $\frac{1}{16}$ " I.D.	150,000	0.156"	$\frac{3}{8}$ " ULTRA HIGH PRESSURE (XF6)	304 SS	150-9X6

## Nipples

Nipples in lengths other than those shown are supplied upon request. Nipples are not furnished with collars and glands, unless specified at time of order.

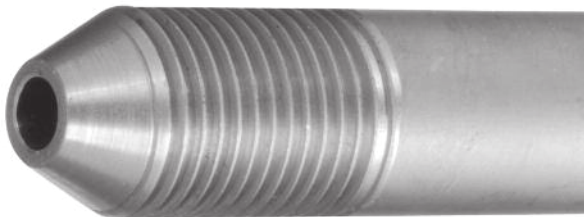

## Coned and Threaded Nipples

Length ↓	Tubing Size (O.D. x I.D.)		
	$\frac{1}{4}$ " O.D. x $\frac{1}{16}$ " I.D. (316 SS)	$\frac{1}{4}$ " O.D. x $\frac{1}{16}$ " I.D. (304 SS)	$\frac{3}{8}$ " O.D. x $\frac{1}{16}$ " I.D. (304 SS)
psi →	100,000 psi	100,000 psi	150,000 psi
$2\frac{3}{4}$ "	100-XM4-2.75	100-XM4-2.75	
4"			150-XM6-4
6"	100-XM4-6	100-XM4-6	150-XM6-6
8"	100-XM4-8	100-XM4-8	150-XM6-8
10"	100-XM4-10	100-XM4-10	150-XM6-10
12"	100-XM4-12	100-XM4-12	150-XM6-12

## Ultra High Pressure Connections (Coned and Threaded) 100,000 and 150,000 psi service

The Ultra High Pressure tubing connection is available for 1/4" and 3/8" O.D. tubing. The tubing may be prepared with the use of tooling (see Tooling section 15) or prepared at the factory to specified lengths. Additionally, standard length coned and threaded nipples are available from stock, see page 60.

This connection has become an industry standard for use at elevated pressures and temperatures in both liquid and gas applications. It may be disassembled and retightened indefinitely.

The threads of the gland are right-hand while the threads of the collar and tubing are left-hand to prevent rotation of the collar during assembly.

**Materials.** All of the components required for make-up of a Ultra High Pressure connection (glands, collars and plugs) are produced in Type 316 stainless steel.

**Necessary glands and collars** are provided with all valves and fittings (except nipples) unless otherwise requested (see chart on the right for size details and catalog numbers).

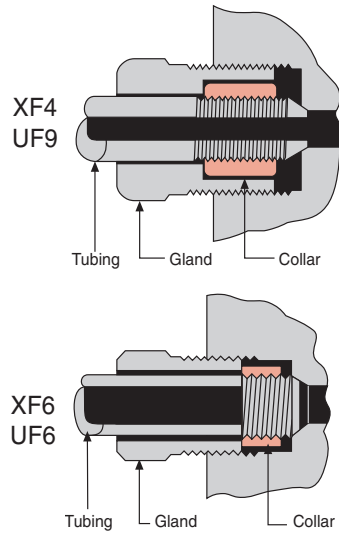

	100,000 psi			150,000 psi
	<b>XF4</b> 1/4" O.D. Tubing	<b>UF6</b> 3/8" O.D. Tubing	<b>UF9</b> 9/16" O.D. Tubing	<b>XF6</b> 3/8" O.D. Tubing
<b>Female Opening Detail</b>				
<b>Gland</b>				
<b>Collar</b>				
<b>Plug</b>				
<b>Tube End Prep</b>				

6



# High Pressure Equipment

## Air Operated Valves

High Pressure Equipment Company offers five lines of air operators to accommodate remote operation of pressure valves up to 100,000 psi. Various models of diaphragm and piston operated valves are available in both normally open and normally closed models, and can be controlled by air regulator, electrical solenoid or low pressure manual valve. The Remetco line of air operated metering valves provides remote operation for fine metering applications.

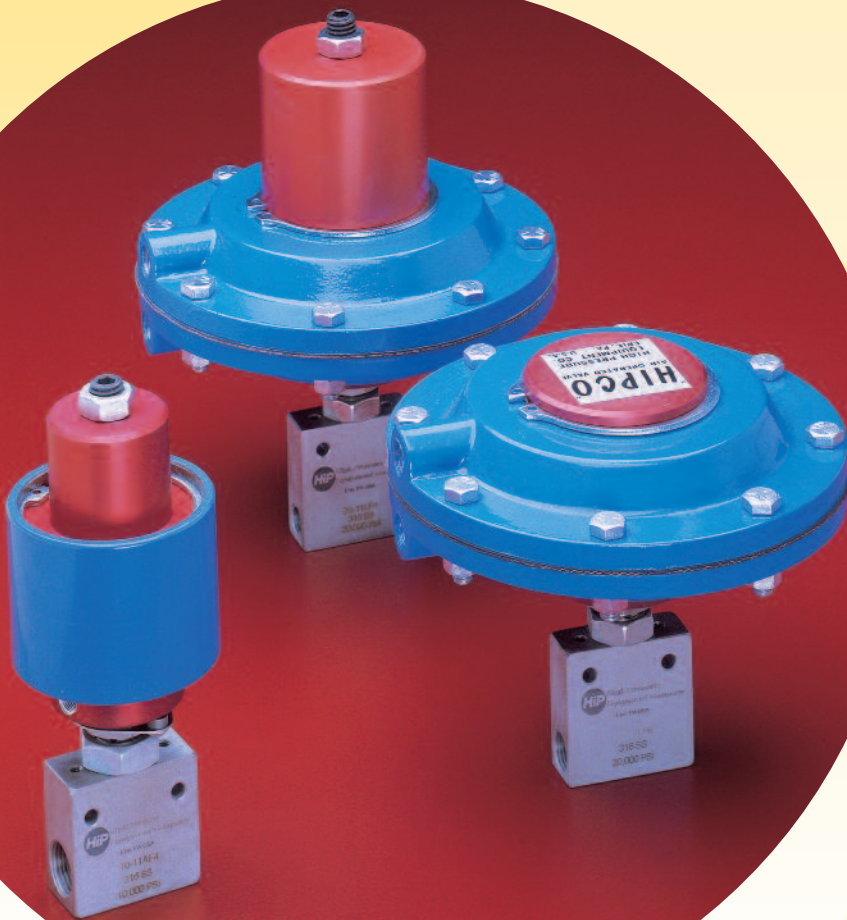

### Index

Mini-Hippo Piston Air Operators .....	.63
Hipco Diaphragm Air Operators .....	.64
Remarco Diaphragm Air Operators .....	.65
Hippo Piston Air Operators .....	.66
Remetco Piston Air Operated Fine Metering Valves .....	.67
Packing Options .....	.68



## 6,000 psi Mini-Hippo Piston Air Operators for Remote Operation

Mini-Hippo Air Operators are available for both normally open service (spring to open/air to close) and for normally closed service (air to open/spring to close). These piston air operators provide remote automatic on/off operation of valves and can be controlled by means of an air regulator, an electrical solenoid, or a manual low pressure valve in the user's air supply line. Air inlet is 1/8" NPT. Air pressure requirement ranges from 50 to 90 psi.

The Mini-Hippo air operators may be supplied with the valves and operating pressures shown in table.

To order simply specify catalog number of valve and type operation required.

EXAMPLES: 30-11HF4-MHNC (normally closed)  
 10-12AF6-MHNO (normally open)  
 10-15AF4-MHNO-MHNC (normally open/normally closed)

### Normally Open (Spring To Open / Air To Close)

Valve Series	Maximum Operating Pressure	Approximate Air Pressure to Seat Valve
15- <b>**AF2</b>	6,000 psi	55 psi
10- <b>**AF4</b>	6,000 psi	55 psi
10- <b>**AF6</b>	6,000 psi	55 psi
30- <b>**HF4</b>	6,000 psi	55 psi
30- <b>**HF6</b>	6,000 psi	55 psi
30- <b>**HF9</b>	6,000 psi	55 psi

### Normally Closed (Air To Open / Spring To Close)

Valve Series	Maximum Operating Pressure	Minimum Adjusting Screw Torque	Approximate Air Pressure to Unseat Valve	Approximate Air Pressure to Fully Open Valve
10- <b>**AF4</b>	6,000 psi	15 in. lb.	50 psi	90 psi
10- <b>**AF6</b>	6,000 psi	15 in. lb.	50 psi	90 psi
30- <b>**HF4</b>	6,000 psi	15 in. lb.	50 psi	90 psi
30- <b>**HF6</b>	6,000 psi	15 in. lb.	50 psi	90 psi
30- <b>**HF9</b>	6,000 psi	15 in. lb.	50 psi	90 psi

\*\* Standard Valve Patterns (reference Page 8)

OPTIONS: *Stems & Seats* . . . Carbide (for cyclic service)  
 Stellite (for cyclic service)  
 17-4 (for cyclic service)

*Valve Bodies* . . . . Hastelloy C, Hastelloy B  
 Inconel 600, Inconel 625  
 Incoloy 800, Incoloy 825  
 Titanium Grade 2, Titanium 6AL4V  
 Nickel  
 Monel

7

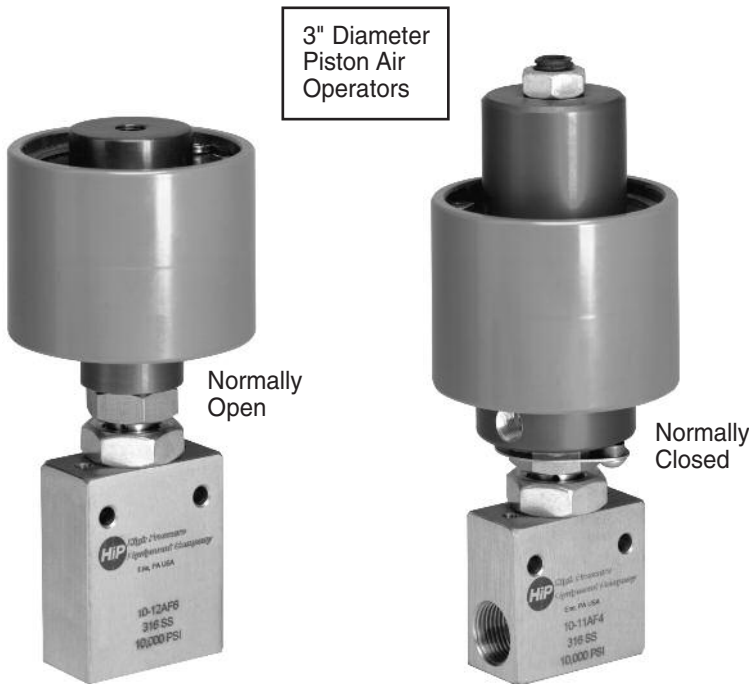

# Air Operated Valves

## Hipco Diaphragm Air Operators for Remote Operation

To 60,000 psi

Hipco Air Operators are available for both normally open service (spring to open/air to close) and for normally closed service (air to open/spring to close). These diaphragm air operators provide remote automatic on/off operation of valves and can be controlled by means of an air regulator, an electrical solenoid, or a manual low pressure valve in the user's air supply line. Air inlet is 1/4" NPT.

The Hipco air operators may be supplied with the valves and operating pressures shown in table.

To order simply specify catalog number of valve and type operation required.

EXAMPLES:

- 30-11HF4-NC (normally closed)
- 10-12NFB-NO (normally open)
- 10-15AF4-NO-NC (normally open/normally closed)

OPTIONS: . . . . .

*Stems & Seats* . . . Carbide (for cyclic service)  
Stellite (for cyclic service)  
17-4 (for cyclic service)

*Valve Bodies* . . . . Hastelloy C, Hastelloy B  
Inconel 600, Inconel 625  
Incoloy 800, Incoloy 825  
Titanium Grade 2,  
Titanium 6AL4V  
Nickel  
Monel

*Packing* . . . . . PolyPak, High Cyclic

*Temperature*

*Considerations* . . . Extended stuffing box for temperatures from -423°F to 1,200°F (medium and high pressure connections only)

6 7/8" Diameter Diaphragm Air Operators

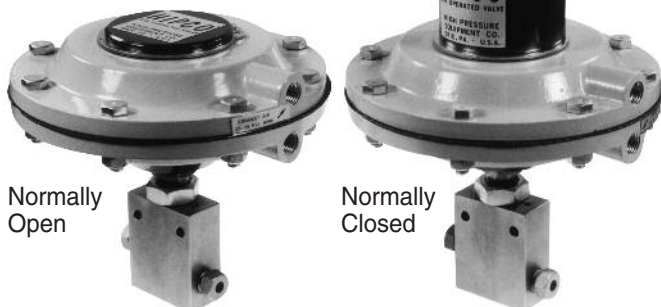

### Normally Open (Spring To Open / Air To Close)

Valve Series	Maximum Operating Pressure	Approximate Air Pressure to Seat Valve
10-**AF4	10,000 psi	35 psi
10-**AF6	10,000 psi	35 psi
10-**NFA	10,000 psi	35 psi
10-**NFB	10,000 psi	35 psi
10-**NFC	10,000 psi	35 psi
15F-**NFA	15,000 psi	85 psi
15F-**NFB	15,000 psi	85 psi
15F-**NFC	10,000 psi	100 psi
15F-**NFD	10,000 psi	100 psi
20-**LF4	20,000 psi	60 psi
20-**LF6	15,000 psi	85 psi
20-**LF9	10,000 psi	100 psi
30-**HF4	30,000 psi	60 psi
30-**HF6	30,000 psi	85 psi
30-**HF9	30,000 psi	85 psi
40-**HF9	30,000 psi	85 psi
60-**HF4	60,000 psi	70 psi
60-**HF6	60,000 psi	70 psi
60-**HF9	60,000 psi	70 psi

### Normally Closed (Air To Open / Spring To Close)

Valve Series	Maximum Operating Pressure	Minimum Adjusting Screw Torque	Approximate Air Pressure to Unseat Valve	Approximate Air Pressure to Fully Open Valve
10-**AF4	10,000 psi	20 in. lb.	30 psi	45 psi
10-**AF6	10,000 psi	20 in. lb.	30 psi	45 psi
10-**NFA	10,000 psi	20 in. lb.	30 psi	45 psi
10-**NFB	10,000 psi	20 in. lb.	30 psi	45 psi
10-**NFC	10,000 psi	20 in. lb.	30 psi	45 psi
15F-**NFA	15,000 psi	60 in. lb.	80 psi	100 psi
15F-**NFB	15,000 psi	60 in. lb.	80 psi	100 psi
15F-**NFC	10,000 psi	75 in. lb.	95 psi	100 psi
15F-**NFD	10,000 psi	75 in. lb.	95 psi	100 psi
20-**LF4	20,000 psi	40 in. lb.	55 psi	90 psi
20-**LF6	15,000 psi	60 in. lb.	80 psi	100 psi
20-**LF9	10,000 psi	75 in. lb.	95 psi	100 psi
30-**HF4	30,000 psi	40 in. lb.	55 psi	75 psi
30-**HF6	30,000 psi	60 in. lb.	80 psi	100 psi
30-**HF9	30,000 psi	60 in. lb.	80 psi	100 psi
40-**HF9	30,000 psi	60 in. lb.	80 psi	100 psi
60-**HF4	60,000 psi	50 in. lb.	65 psi	85 psi
60-**HF6	60,000 psi	50 in. lb.	65 psi	85 psi
60-**HF9	60,000 psi	50 in. lb.	65 psi	85 psi

\*\* Standard Valve Patterns (reference Page 8)

## Remarco Diaphragm Operated Valves for Remote Operation

### To 100,000 psi

Remarco air operated valves are available for both normally open service (spring to open/air to close) and for normally closed service (air to open/spring to close). These diaphragm operated valves provide remote operation up to 100,000 psi by means of an air input supply ranging from 25 to 90 psi to the air actuator.

An electrical solenoid valve for the air supply is provided with all Remarco valves and is mounted directly to the valve. The standard solenoid is 120 volt, 60 cycle, 11 watts with 1/8" NPT air inlet. (Other voltages available at additional charge—consult factory). The solenoid is normally closed and when energized allows air into the diaphragm casing to activate the valve. In the event of an electrical or air line failure, the valve will return to its "normal" position.

The Remarco valve features removable stem seats. Valve bodies are 316 stainless steel. Valve stems are hardened 17-4PH stainless steel up to 60,000 psi. Tool steel stems are standard on 100,000 psi valves. Standard packing on the 30,000 psi and 60,000 psi Remarco valves is Teflon O-ring with Buna-N, Viton, or Silicone, available at no additional cost.

### Normally Open (Spring To Open / Air To Close)

Valve Series	Maximum Operating Pressure	Approximate Air Pressure to Seat Valve	Orifice	Connections	Tubing Size	
					O.D.	I.D.
D10R12LF9R	10,000 psi	60 psi	1/4"	LF9	9/16"	5/16"
D20R12LF9R	20,000 psi	75 psi	1/4"	LF9	9/16"	5/16"
D30R12HF4R	30,000 psi	65 psi	1/8"	HF4	1/4"	.083"
D30R12HF6R	30,000 psi	65 psi	1/8"	HF6	3/8"	1/8"
D30R12HF9R	30,000 psi	65 psi	1/8"	HF9	9/16"	3/16"
D10R12HF9R	10,000 psi	60 psi	1/4"	HF9	9/16"	5/16"
D60R12HF4R	60,000 psi	55 psi	1/16"	HF4	1/4"	1/16"
D60R12HF6R	60,000 psi	55 psi	1/16"	HF6	3/8"	1/8"
D60R12HF9R	60,000 psi	55 psi	1/16"	HF9	9/16"	3/16"
D100R12XF4R	100,000 psi	40 psi	1/16"	XF4	1/4"	1/16"
D100R12XF6R	100,000 psi	50 psi	1/16"	XF6	3/8"	1/16"

### Normally Closed (Air To Open / Spring To Close)

Valve Series	Maximum Operating Pressure	Lock Nut Torque Setting	Approximate Air Pressure to Unseat Valve	Approximate Air Pressure to Fully Open Valve	Orifice	Connections	Tubing Size	
							O.D.	I.D.
SD10R12LF9R	10,000 psi	20 ft. lb.	55 psi	90 psi	1/4"	LF9	9/16"	5/16"
SD20R12LF9R	20,000 psi	40 ft. lb.	70 psi	90 psi	1/4"	LF9	9/16"	5/16"
SD30R12HF4R	30,000 psi	20 ft. lb.	60 psi	75 psi	1/8"	HF4	1/4"	.083"
SD30R12HF6R	30,000 psi	20 ft. lb.	60 psi	75 psi	1/8"	HF6	3/8"	1/8"
SD30R12HF9R	30,000 psi	20 ft. lb.	60 psi	75 psi	1/8"	HF9	9/16"	3/16"
SD10R12HF9R	10,000 psi	20 ft. lb.	55 psi	90 psi	1/4"	HF9	9/16"	5/16"
SD60R12HF4R	60,000 psi	20 ft. lb.	50 psi	65 psi	1/16"	HF4	1/4"	1/16"
SD60R12HF6R	60,000 psi	20 ft. lb.	50 psi	65 psi	1/16"	HF6	3/8"	1/8"
SD60R12HF9R	60,000 psi	20 ft. lb.	50 psi	65 psi	1/16"	HF9	9/16"	3/16"
SD100R12XF4R	100,000 psi	30 ft. lb.	85 psi	100 psi	1/16"	XF4	1/4"	1/16"
SD100R12XF6R	100,000 psi	30 ft. lb.	85 psi	100 psi	1/16"	XF6	3/8"	1/16"

7

9 7/8" Diameter Diaphragm Air Operators

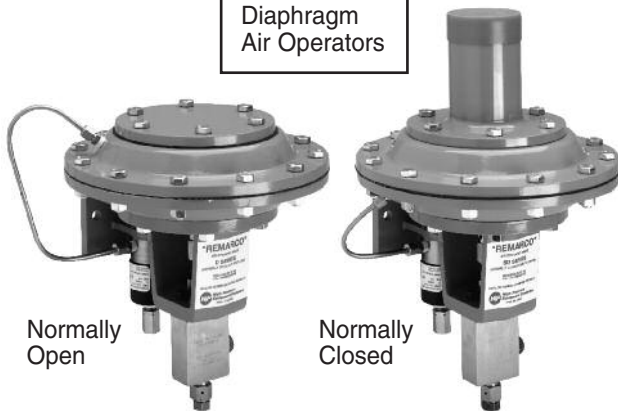

- OPTIONS: *Stems & Seats* . . . Carbide (for cyclic service)  
 Stellite (for cyclic service)
- Valve Bodies* . . . . MP35N – water service 100K valve  
 Hastelloy C, Hastelloy B  
 Inconel 600, Inconel 625  
 Incoloy 800, Incoloy 825  
 Titanium Grade 2, Titanium 6AL4V  
 Nickel, Monel
- Packing* . . . . . PolyPak, High Cyclic

# Air Operated Valves

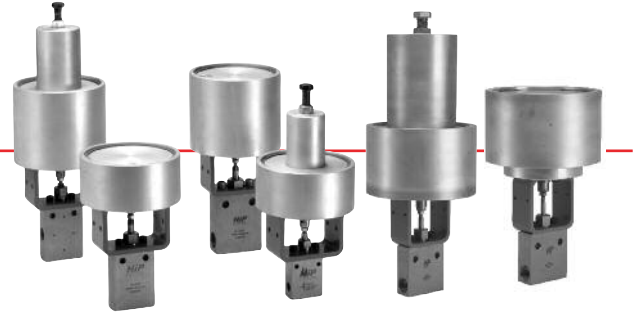

## Hippo Piston Air Operators for Remote Operation

### To 60,000 psi

Hippo Piston Air Operators are available for both normally open service (spring to open/air to close) and for normally closed service (air to open/spring to close). These piston air operators provide remote automatic on/off operation of valves and can be controlled by means of an air regulator, an electrical solenoid, or a manual low pressure valve in the user's air supply line. Air inlet is 1/8" NPT. Air pressure requirement ranges from 35 psi to 120 psi.

These operators may be supplied with the valves and operating pressures shown in table.

### Normally Closed (Air To Open / Spring To Close) Medium Duty

Valve Series	Maximum Operating Pressure	Orifice Size	Minimum Adjusting Screw Torque	Approximate Air Pressure to Unseat Valve	Approximate Air Pressure to Fully Open	Part Number Suffix
10-**AF4	10,000 psi	1/8"	25 in.lb.	30 psi	40 psi	MPO-NC
10-**AF6	10,000 psi	1/8"	25 in.lb.	30 psi	40 psi	MPO-NC
15F-**NFA	15,000 psi	13/64"	45 in.lb.	55 psi	75 psi	MPO-NC
15F-**NFB	15,000 psi	13/64"	45 in.lb.	55 psi	75 psi	MPO-NC
15F-**NFC	10,000 psi	5/16"	55 in.lb.	70 psi	95 psi	MPO-NC
15F-**NFD	10,000 psi	5/16"	55 in.lb.	70 psi	95 psi	MPO-NC
20-**LF4	20,000 psi	1/8"	50 in.lb.	70 psi	95 psi	MPO-NC
20-**LF6	20,000 psi	13/64"	55 in.lb.	70 psi	95 psi	MPO-NC
20-**LF9	10,000 psi	5/16"	55 in.lb.	70 psi	95 psi	MPO-NC
30-**HF4	30,000 psi	3/32"	50 in.lb.	60 psi	75 psi	MPO-NC
30-**HF6	30,000 psi	1/8"	55 in.lb.	60 psi	75 psi	MPO-NC
30-**HF9	30,000 psi	1/8"	55 in.lb.	60 psi	75 psi	MPO-NC
60-**HF4	60,000 psi	1/16"	50 in.lb.	50 psi	65 psi	MPO-NC
60-**HF6	60,000 psi	1/16"	50 in.lb.	50 psi	65 psi	MPO-NC
60-**HF9	60,000 psi	1/16"	50 in.lb.	50 psi	65 psi	MPO-NC

### Heavy Duty

15F-**NFC	15,000 psi	5/16"	85 in.lb.	60 psi	75 psi	HPO-NC
15F-**NFD	15,000 psi	5/16"	85 in.lb.	60 psi	75 psi	HPO-NC
20-**LF4	20,000 psi	1/8"	55 in.lb.	35 psi	50 psi	HPO-NC
20-**LF6	20,000 psi	13/64"	60 in.lb.	35 psi	50 psi	HPO-NC
20-**LF9	16,000 psi	5/16"	85 in.lb.	60 psi	75 psi	HPO-NC
20-**LF12	9,000 psi	7/16"	85 in.lb.	60 psi	75 psi	HPO-NC
20-**LF16	6,000 psi	9/16"	85 in.lb.	60 psi	75 psi	HPO-NC
30-**HF4	30,000 psi	3/32"	50 in.lb.	30 psi	40 psi	HPO-NC
30-**HF6	30,000 psi	1/8"	55 in.lb.	30 psi	40 psi	HPO-NC
30-**HF9	30,000 psi	1/8"	55 in.lb.	30 psi	40 psi	HPO-NC
60-**HF4	60,000 psi	1/16"	50 in.lb.	25 psi	35 psi	HPO-NC
60-**HF6	60,000 psi	1/16"	50 in.lb.	25 psi	35 psi	HPO-NC
60-**HF9	60,000 psi	1/16"	50 in.lb.	25 psi	35 psi	HPO-NC

### Extra Heavy Duty

20-**LF12	20,000 psi	7/16"	60 ft.lb.	35 psi	60 psi	EHPO-NC
10-**NFF	10,000 psi	11/16"	75 ft.lb.	45 psi	70 psi	EHPO-NC
10-**NFH	10,000 psi	11/16"	75 ft.lb.	45 psi	70 psi	EHPO-NC
10-**LF16	10,000 psi	11/16"	75 ft.lb.	45 psi	70 psi	EHPO-NC
20-**LF16	20,000 psi	9/16"	95 ft.lb.	55 psi	95 psi	EHPO-NC
30-**HF16	30,000 psi	7/16"	90 ft.lb.	50 psi	85 psi	EHPO-NC

To order simply specify catalog number of valve and appropriate suffix of operator required.

EXAMPLES: 20-11LF4-MPO-NC (normally closed)  
20-12LF6-HPO-NO (normally open)

### OPTIONS:

Stems & Seat . . . Carbide, ceramic or Stellite (for cyclic service)

Valve Bodies . . . Hastelloy C, Hastelloy B  
Inconel 600, Inconel 625  
Incoloy 800, Incoloy 825  
Titanium Grade 2, Titanium 6AL4V  
Nickel  
Monel

Packing . . . . . PolyPak, High Cyclic

### Temperature

Consideration . . . Extended stuffing box for temperatures from -423°F to 1,200°F (medium and high pressure connections only)

### Normally Open (Spring To Open / Air To Close)

#### Medium Duty

Valve Series	Maximum Operating Pressure	Orifice Size	Approximate Air Pressure to Seat Valve	Part Number Suffix
10-**AF4	10,000 psi	1/8"	35 psi	MPO-NO
10-**AF6	10,000 psi	1/8"	35 psi	MPO-NO
15F-**NFA	15,000 psi	13/64"	75 psi	MPO-NO
15F-**NFB	15,000 psi	13/64"	75 psi	MPO-NO
15F-**NFC	10,000 psi	5/16"	100 psi	MPO-NO
15F-**NFD	10,000 psi	5/16"	100 psi	MPO-NO
20-**LF4	20,000 psi	1/8"	95 psi	MPO-NO
20-**LF6	20,000 psi	13/64"	100 psi	MPO-NO
20-**LF9	10,000 psi	5/16"	100 psi	MPO-NO
20-**LF12	6,000 psi	7/16"	100 psi	MPO-NO
30-**HF4	30,000 psi	3/32"	60 psi	MPO-NO
30-**HF6	30,000 psi	1/8"	60 psi	MPO-NO
30-**HF9	30,000 psi	1/8"	60 psi	MPO-NO
60-**HF4	60,000 psi	1/16"	55 psi	MPO-NO
60-**HF6	60,000 psi	1/16"	55 psi	MPO-NO
60-**HF9	60,000 psi	1/16"	55 psi	MPO-NO

#### Heavy Duty

15F-**NFC	15,000 psi	5/16"	75 psi	HPO-NO
15F-**NFD	15,000 psi	5/16"	75 psi	HPO-NO
20-**LF4	20,000 psi	1/8"	55 psi	HPO-NO
20-**LF6	20,000 psi	13/64"	55 psi	HPO-NO
20-**LF9	20,000 psi	5/16"	95 psi	HPO-NO
20-**LF12	13,000 psi	7/16"	100 psi	HPO-NO
20-**LF16	8,800 psi	9/16"	100 psi	HPO-NO
30-**HF4	30,000 psi	3/32"	35 psi	HPO-NO
30-**HF6	30,000 psi	1/8"	35 psi	HPO-NO
30-**HF9	30,000 psi	1/8"	35 psi	HPO-NO
60-**HF4	60,000 psi	1/16"	30 psi	HPO-NO
60-**HF6	60,000 psi	1/16"	30 psi	HPO-NO
60-**HF9	60,000 psi	1/16"	30 psi	HPO-NO

#### Extra Heavy Duty

20-**LF12	20,000 psi	7/16"	55 psi	EHPO-NO
10-**NFF	10,000 psi	11/16"	45 psi	EHPO-NO
10-**NFH	10,000 psi	11/16"	45 psi	EHPO-NO
10-**LF16	10,000 psi	11/16"	45 psi	EHPO-NO
20-**LF16	20,000 psi	9/16"	55 psi	EHPO-NO
30-**HF16	30,000 psi	7/16"	50 psi	EHPO-NO

\*\* Standard Valve Patterns (reference Page 8)



## Remetco Piston Operated Fine Metering Valves

### For Liquids or Gases

Precise control with fast response is possible in fine metering applications to 60,000 psi with Remetco Valves. Pinpoint accuracy and repeatability are assured by a unique stem travel control device working in concert with a Conoflow operator, which is actuated by an input air pressure of only 15 psi.

Body material is Type 316 stainless steel, with both stem and removable seat of 17-4PH. The stem tip is ground to a 9° included taper, with orifice sizes as listed in the ordering table.

Installation requires only connection to an air supply of 20 to 100 psi. This is connected both to the supply air connection and to the instrument air inlet. The latter is regulated between 3 and 15 psi to actuate the valve to the desired position.

Regulation is effected by the user's instrument or by the optional instrument panel at lower right. Thus the valve is in its full open position with a 3 psi air input and in the closed position with a 15 psi air input.

**Failsafe operation.** In standard configuration, the valve OPENS upon failure of the air supply. It may also be supplied to close upon air failure, to open upon an increase in air signal, or any combination of these specifications.

**Remote Valve Positioner "RVP."** Optional instrument panel shown at bottom can be ordered as an accessory. It is a manually operated remote air signal valve positioner which permits positioning the stem at any desired point within the 1 1/8" travel of the stem (1 1/2" travel on 20M series). The dial indicator is graduated into 100 increments; thus each dial increment moves the stem 0.0112".

**Standard inlet and outlet connections** to the Remetco Valve are for 9/16" OD coned and threaded tubing. Adapters may be supplied for other tubing sizes upon request.

**Shutoff not recommended.** While this valve is capable of on-off operation, it is designed as a fine metering instrument. To assure maximum stem life, a manual on-off valve should be used in the line upstream of the Remetco Valve.

**To order,** use assembly number in table and specify if operation is to be other than the standard closure upon air failure. Add "RVP" as suffix if remote air signal valve positioner is desired.

## Ordering Table

Assembly Number	Pressure Rating	Orifice Size	CV
10M-12HF9R	10,000 psi	1/4"	1.2
20M-12LF12R	20,000 psi	3/8"	1.8
30M-12HF9R	30,000 psi	1/8"	0.22
60M-12HF9R	60,000 psi	1/16"	0.06

OPTIONS: *Stems & Seats* . . . Carbide (for cyclic service)  
Stellite (for cyclic service)

*Valve Bodies* . . . . . Hastelloy-C, Hastelloy B  
Inconel 600, Inconel 625  
Incoloy 800, Incoloy 825  
Titanium Grade 2, Titanium GAL4V  
Nickel  
Monel

*Packing* . . . . . PolyPak available for  
LF12 series only



Dimensions shown for 10M, 30M and 60M size. Consult factory for 20M dimensions.



Remote Valve Stem Positioner "RVP" above permits remote positioning of valve stem in increments of 0.0112". To order, add suffix "RVP" to base order number.

# Packing Options

## NPT Air Operated Valves

### HIPCO 10,000 psi Series

Material	Part Number
	NFA NFB
Teflon*	B-181
Grafoil	B-1417
Buna-N	B-102
Viton	B-849
Silicone	B-147

### HIPCO 15,000 psi Series

Material	Part Number	
	NFA NFB	NFC NFD
Teflon*	B-1392 Set	207341 Set
Grafoil	B-1391 Set	B-1386 Set
Polypak	B-1388 (1)	B-1387 (1)

### HIPPO 15,000 psi Series

Material	Part Number	
	NFA NFB	NFC NFD
Teflon*	B-1392 Set	207341 Set
Grafoil	B-1391 Set	B-1386 Set
Polypak	B-1388 (1)	B-1387 (1)

## Air Operated Valves

### HIPCO Taper Seal

Material	Part Number
	AF4 AF6
Teflon*	B-181
Buna-N	B-102
Viton	B-849
Silicone	B-147

### HIPPO Taper Seal

Material	Part Number
	AF4 AF6
Teflon*	B-181
Buna-N	B-102
Viton	B-849
Silicone	B-147

### Mini HIPPO

Material	Part Number		
	AF2	AF4/ AF6	HF4/HF6/ HF9
Teflon*	B-195	B-181	B-181
Buna-N	B-101	B-102	B-102
Viton	B-614	B-849	B-849
Silicone	B-149	B-147	B-147

### HIPCO Medium Pressure

Material	Part Number	
	LF4/ LF6	LF9
Teflon*	B-1392 Set	207341 Set
Grafoil	B-1391 Set	B-1386 Set
Polypak	B-1388 (1)	B-1387 (1)

### HIPPO Medium Pressure

Material	Part Number	
	LF4/ LF6	LF9
Teflon*	B-1392 Set	207341 Set
Grafoil	B-1391 Set	B-1386 Set
Polypak	B-1388 (1)	B-1387 (1)

### HIPCO High Pressure 30,000 psi

Material	Part Number
	HF4/HF6/ HF9
Teflon*	B-181
Grafoil	B-1417
TFE/Buna-N	209276

### HIPPO High Pressure 30,000 psi

Material	Part Number
	HF4/HF6/ HF9
Teflon*	B-181
Grafoil	B-1417
TFE/Buna-N	209276

### HIPCO High Pressure 60,000 psi

Material	Part Number
	HF2/HF4/ HF6/HF9
Teflon/Nylon**	209689
Grafoil	B-1379
TFE/Viton	212401

### HIPPO High Pressure 60,000 psi

Material	Part Number
	HF2/HF4/ HF6/HF9
Teflon/Nylon**	209689
Grafoil	B-1379
TFE/Viton	212401

## Temperature Ratings for Packing Options

Material	Maximum Temperature Rating
Buna-N	200°F
Grafoil	800°F
PolyPak	200°F
Silicone	400°F
Teflon	450°F
TFE/Nylon	180°F
TFE/Viton	400°F
Viton	400°F

\* Teflon packing supplied as standard

\*\* Teflon/Nylon packing supplied as standard

Note: For pricing see Spare Parts list in Price List





# High Pressure Equipment

## Ball Valves and Subsea Ball Valves

10,000, 15,000 & 20,000 psi service

HiP offers two styles of ball valves (free floating and severe duty trunion) to provide shut-off of liquid or gas flow through 20,000 psi. These valves are available in two-way and three-way configurations, as well as a diverter style in trunion valves.

**Subsea Ball Valves** are designed for the extreme pressures and harsh environments commonly found in the offshore oil and gas industry. HiP offers the industry's broadest line of subsea ball valves for 10, 15 and 20,000 psi.

## Relief Valves

60,000 psi service

**Relief Valves** are engineered to protect a system from over-pressure damage and failure. Relief Valves are available in metal seat, soft seat and field adjustable styles in a variety of pressures ranges up to 60,000 psi. HiP relief valves are now available with CE marking. These products will proudly be marked with the CE symbol, signifying they comply with the stringent requirements of the Pressure Equipment Directive (PED).

## Block & Bleed Valves

20,000 psi service

High Pressure Equipment has developed a line of block and bleed needle valves, double block and bleed needle valves, and double block and bleed ball valves to provide an excellent method of blocking, bleeding and calibrating pressure gauges and transmitters.



### Ball Valves Index

Free Floating Ball Valves	70
Severe Duty Trunion Style Ball Valves	71-72
Ball Valve Actuators	73
Subsea Ball Valves	74-77

### Relief Valves Index

Metal Seat Relief Valves	78
Soft Seat Relief Valves	79
Field Adjustable Relief Valves	80

### Block & Bleed Valves Index

Block and Bleed Needle Valves	81
Double Block and Bleed Needle Valves	82
Double Block and Bleed Ball Valves	83

# Ball Valves

## Ball Valves

### 10,000, 15,000 and 20,000 psi service

High Pressure Equipment offers two styles of ball valves (free floating and trunion) to provide effective shut-off of liquid or gas flow.

Two-way ball valves offer complete shut-off with a convenient  $\frac{1}{4}$  turn. Valve actuators are available for remote control of HiP ball valves.

Virtually all metal components are stainless steel to insure consistent operation under even the most severe applications. Teflon packing provides reliable leak-free service up to 400°F. Other packings, including Polypak and Grafoil are available upon request.

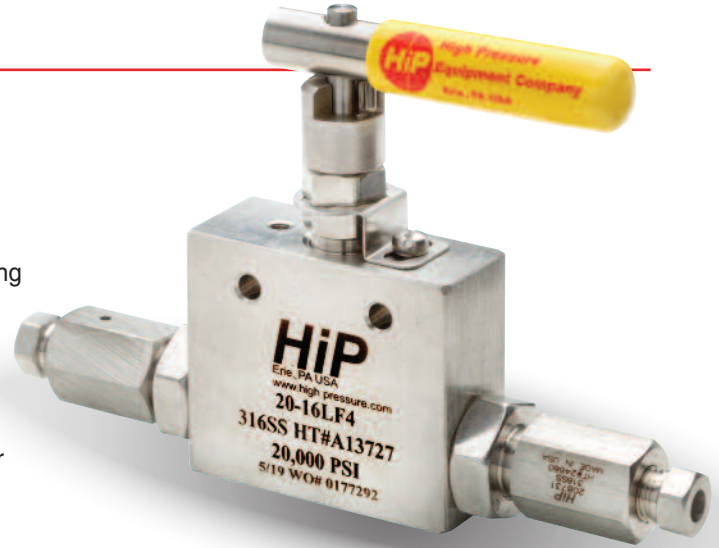

### Two-Way Free Floating Ball Valves

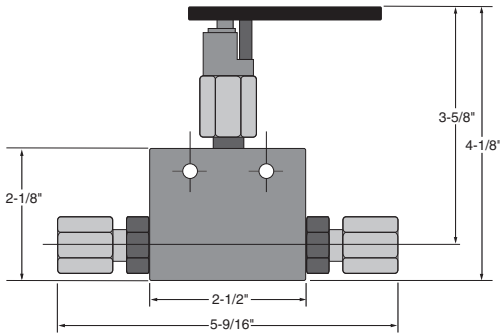

Catalog No.	Tube Size	Conn*	Pressure Rating @RT	Minimum Orifice	C <sub>v</sub>
15-16AF1	$\frac{1}{16}$ "	AF1	15,000 psi	0.052	0.09
15-16AF2	$\frac{1}{8}$ "	AF2	15,000 psi	0.094	0.20
10-16AF4	$\frac{1}{4}$ "	AF4	10,000 psi	0.125	0.45
10-16AF6	$\frac{3}{8}$ "	AF6	10,000 psi	0.250	2.70
20-16LF4	$\frac{1}{4}$ "	LF4	20,000 psi	0.109	0.31
20-16LF6	$\frac{3}{8}$ "	LF6	20,000 psi	0.203	1.70
20-16LF9	$\frac{9}{16}$ "	LF9	20,000 psi	0.250	2.70
20-16HF2	$\frac{1}{8}$ "	HF2	20,000 psi	0.062	0.12
20-16HF4	$\frac{1}{4}$ "	HF4	20,000 psi	0.094	0.20
20-16HF6	$\frac{3}{8}$ "	HF6	20,000 psi	0.125	0.45
20-16HF9	$\frac{9}{16}$ "	HF9	20,000 psi	0.188	1.45
15-16NFA	$\frac{1}{8}$ "	$\frac{1}{8}$ " NPT	15,000 psi	0.250	2.70
15-16NFB	$\frac{1}{4}$ "	$\frac{1}{4}$ " NPT	15,000 psi	0.250	2.70
15-16NFC	$\frac{3}{8}$ "	$\frac{3}{8}$ " NPT	15,000 psi	0.250	2.70
15-16NFD	$\frac{1}{2}$ "	$\frac{1}{2}$ " NPT	15,000 psi	0.250	2.70

\* Other connections available upon request. Consult factory.

## Severe Duty Ball Valves (Trunion Style) 10,000, 15,000 and 20,000 psi service

High Pressure Equipment Company introduces its TRUNION STYLE ball valves for effective shut-off of liquid and gas flow through 20,000 psi @ 400°F maximum. Our offering features a trunion ball design, making this type of valve ideal for severe duty applications. This valve is available in two-way or three-way configurations with orifices of .187", .375", .500" or 1.000".

The two-way ball valve offers complete shut-off with a convenient 1/4 turn. The standard configuration of the three-way ball valve requires 1/2 turn to change port outlets and provides for complete shut-off. An optional diverter style three-way ball valve requires only a 1/4 turn to change the port outlets. Air operated actuators are available for remote control.

Material of construction is 316 stainless steel, O-rings are Viton, ball seat is PEEK. Alternate materials of construction are available upon request.

- Trunion style closure, ideal for severe duty applications
- Two-way and three-way valve configurations
- Three-way, 1/4 turn diverter valve
- .187", .375", .500" or 1.000" orifices
- Air actuators for remote operation
- Convenient panel mount design (cut 1 1/16" diameter hole) .187 and .375 only
- Large selection of tube and pipe fittings available
- Optional wetted parts available
- Optional O-rings available

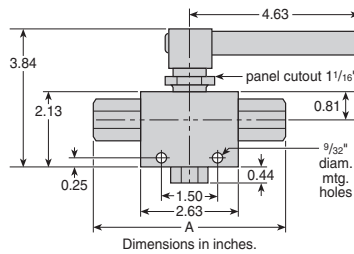

**.187 Orifice**

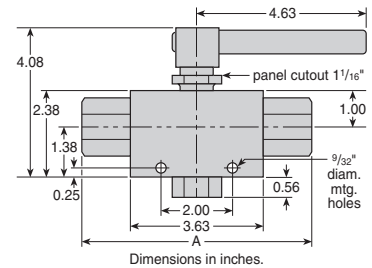

**.375 Orifice**

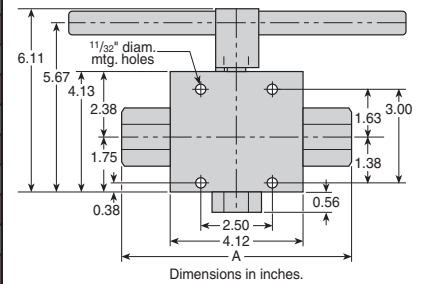

**.500 Orifice**

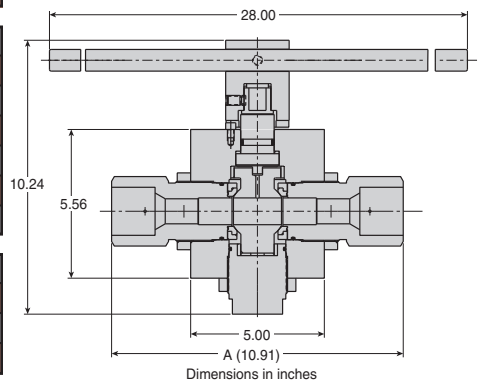

**1.000 Orifice**

## Two-Way Trunion Ball Valves - 90°

Orifice	Tube Size	Connection	Pressure Rating	Minimum Orifice	C <sub>v</sub>	A	Catalog No.
.187	1/16"	AF1	15,000 psi	.052	0.09	4.19	15-71AF1
	1/8"	AF2	15,000 psi	.094	0.20	4.19	15-71AF2
	1/4"	AF4	10,000 psi	.125	0.45	4.69	10-71AF4
	3/8"	AF6	10,000 psi	.187	1.45	4.69	10-71AF6
	1/4"	LF4	20,000 psi	.109	0.31	4.63	20-71LF4
	3/8"	LF6	20,000 psi	.187	1.45	4.63	20-71LF6
	9/16"	LF9	20,000 psi	.187	1.45	5.13	20-71LF9
	1/4"	HF4	20,000 psi	.094	0.20	4.63	20-71HF4
	3/8"	HF6	20,000 psi	.125	0.45	4.63	20-71HF6
	9/16"	HF9	20,000 psi	.187	1.45	4.87	20-71HF9
	1/8"	1/8" NPT	15,000 psi	.187	1.45	4.63	15-71NFA
	1/4"	1/4" NPT	15,000 psi	.187	1.45	4.63	15-71NFB
3/8"	3/8" NPT	15,000 psi	.187	1.45	4.65	15-71NFC	
.375	3/8"	AF6	10,000 psi	.250	2.70	5.13	10-74AF6
	9/16"	LF9	15,000 psi	.312	4.22	6.25	15-74LF9
	3/4"	LF12	15,000 psi	.375	6.08	6.67	15-74LF12
	1"	LF16	15,000 psi	.375	6.08	7.45	15-74LF16
	1/4"	1/4" NPT	15,000 psi	.250	2.70	5.63	15-74NFB
	3/8"	3/8" NPT	15,000 psi	.375	6.08	5.63	15-74NFC
.500	3/4"	LF12	10,000 psi	.500	10.2	6.56	10-80LF12
	1"	LF16	10,000 psi	.500	10.2	7.44	10-80LF16
	3/4"	3/4" NPT	10,000 psi	.500	10.2	6.44	10-80NFF
	1"	1" NPT	10,000 psi	.500	10.2	7.44	10-80NFH
1.000	1 1/2"	LF24	10,000 psi	1.000	30.0	10.91	10-83LF24



# Ball Valves

## Three-Way Trunion Ball Valves

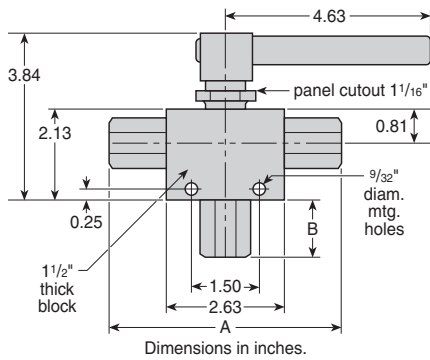

**.187 Orifice**

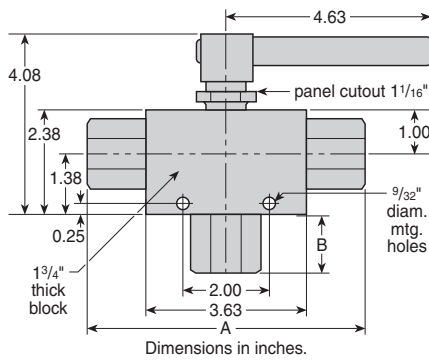

**.375 Orifice**

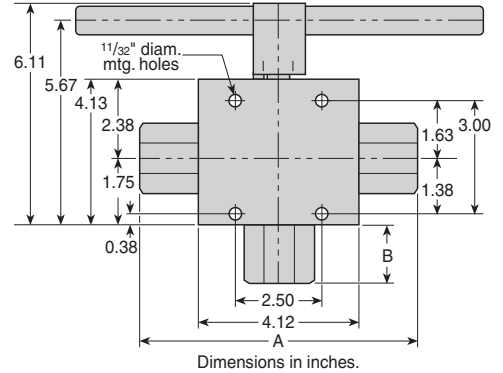

**.500 Orifice**

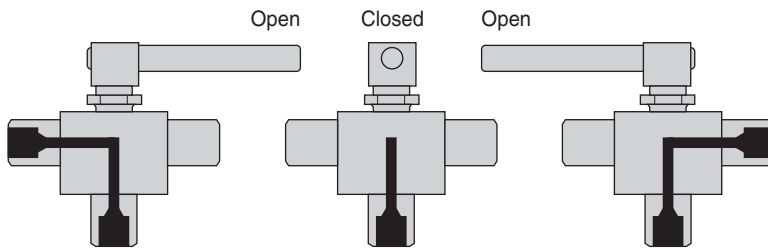

**180° Three-Way Ball Valve**

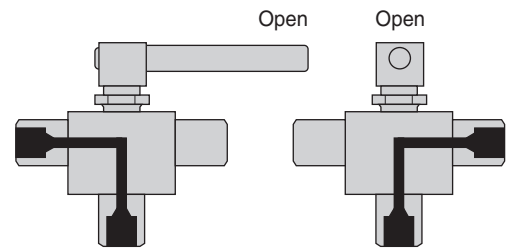

**90° Three-Way Diverter Valve**

8

Orifice	Tube Size	Connection	Pressure Rating	Minimum Orifice	C <sub>v</sub>	A	B	3-Way 90° Catalog No.	3-Way 180° Catalog No.
.187	1/16"	AF1	15,000 psi	.052	0.04	4.19	0.55	15-73AF1	15-72AF1
	1/8"	AF2	15,000 psi	.094	0.10	4.19	0.55	15-73AF2	15-72AF2
	1/4"	AF4	10,000 psi	.125	0.22	4.69	0.83	10-73AF4	10-72AF4
	3/8"	AF6	10,000 psi	.187	0.71	4.69	1.01	10-73AF6	10-72AF6
	1/4"	LF4	20,000 psi	.109	0.15	4.63	1.00	20-73LF4	20-72LF4
	3/8"	LF6	20,000 psi	.187	0.71	4.63	1.00	20-73LF6	20-72LF6
	9/16"	LF9	20,000 psi	.187	0.71	5.13	1.25	20-73LF9	20-72LF9
	1/4"	HF4	20,000 psi	.094	0.10	4.63	0.81	20-73HF4	20-72HF4
	3/8"	HF6	20,000 psi	.125	0.22	4.63	0.94	20-73HF6	20-72HF6
	9/16"	HF9	20,000 psi	.187	0.71	4.87	1.19	20-73HF9	20-72HF9
	1/8"	1/8" NPT	15,000 psi	.187	0.71	4.63	0.50	15-73NFA	15-72NFA
	1/4"	1/4" NPT	15,000 psi	.187	0.71	4.63	1.06	15-73NFB	15-72NFB
3/8"	3/8" NPT	15,000 psi	.187	0.71	4.65	1.06	15-73NFC	15-72NFC	
.375	3/8"	AF6	10,000 psi	.250	1.07	5.13	0.75	10-76AF6	10-75AF6
	9/16"	LF9	15,000 psi	.312	1.67	6.25	1.06	15-76LF9	15-75LF9
	3/4"	LF12	15,000 psi	.375	2.40	6.67	1.18	15-76LF12	15-75LF12
	1"	LF16	15,000 psi	.375	2.40	7.45	1.99	15-76LF16	15-75LF16
	1/4"	1/4" NPT	15,000 psi	.250	1.07	5.63	1.06	15-76NFB	15-75NFB
	3/8"	3/8" NPT	15,000 psi	.375	2.40	5.63	1.06	15-76NFC	15-75NFC
	1/2"	1/2" NPT	15,000 psi	.375	2.40	5.63	1.06	15-76NFD	15-75NFD
.500	3/4"	LF12	10,000 psi	.500	7.43	6.56	1.30	10-82LF12	10-81LF12
	1"	LF16	10,000 psi	.500	7.43	7.44	1.74	10-82LF16	10-81LF16
	3/4"	3/4" NPT	10,000 psi	.500	7.43	6.44	1.30	10-82NFF	10-81NFF
	1"	1" NPT	10,000 psi	.500	7.43	7.44	1.74	10-82NFH	10-81NFH

## Ball Valve Actuators

High Pressure Equipment Company offers air operated actuators to accommodate remote operation. **NOTE: These air operators are only for use with two-way and three-way diverter style valves.**

**To order:** simply specify the appropriate ball valve catalog number and add the suffix “-TSR8” for air to open/spring to close, or “-TDA8” for air to open and close (double acting) or TSR20 for 0.500 orifice. For trunion only.

Use TDA4 and TSR4 for floating ball style valves.

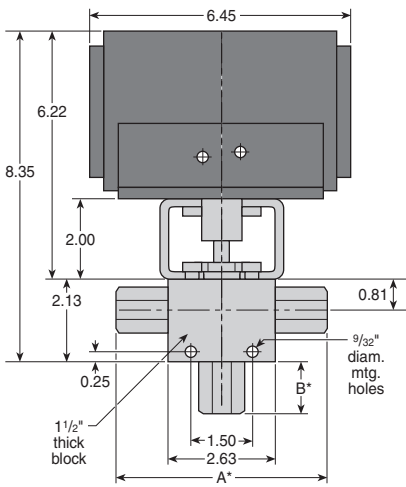
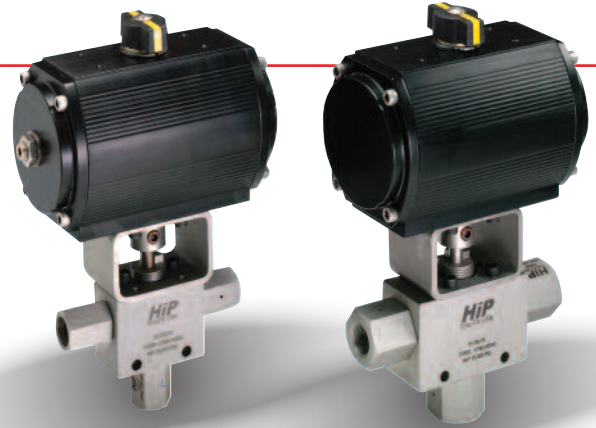

Dimensions in inches.  
\* Dimensions found within charts on pages 6.3-6.4

**.187 Orifice**

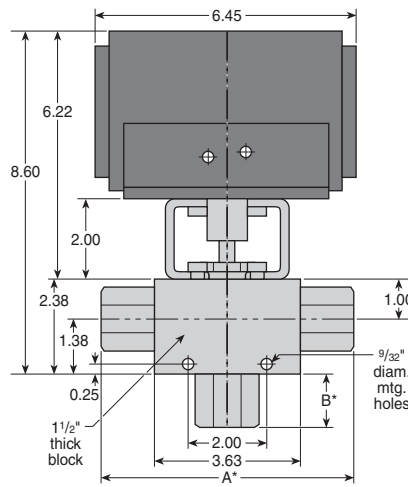

Dimensions in inches.  
\* Dimensions found within charts on pages 6.3-6.4

**.375 Orifice**

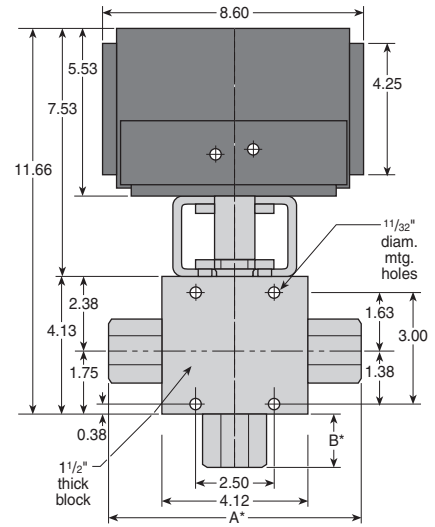

Dimensions in inches.  
\* Dimensions found within charts on pages 6.3-6.4

**.500 Orifice**

**8**



# Ball Valves

## Subsea Ball Valves

In today's offshore oil and gas industry, wells have become deeper than ever, causing a growing demand for subsea ball valves that can withstand extreme pressures and harshest environments. As a leader in developing ways to provide effective shut off under increasing temperature and pressure requirements at greater depths, High Pressure Equipment offers subsea ball valves that provide safe and reliable operation at very high external pressures.

High Pressure Equipment's Subsea Ball Valves feature their reliable trunion style ball design and incorporate the required design modifications for ideal performance in critical subsea systems. HiP offers the industry's widest range of subsea valve sizes, these valves are available in 2 or 3 way configurations with 180° operation or 90° diverter styles in .187", .375" and .500" orifices and 10, 15 and 20,000 psi pressure ranges.

### Subsea Valve Features

- Trunion style ball design
- 316 cold-worked SS construction
- Two and three-way valve configurations
- 90° diverter or 180° styles
- .187", .375" and .500" orifices
- PEEK ball seats, which offers excellent resistance to chemicals, heat and wear/abrasion
- Optional O-rings available
- Optional wetted materials
- Available to NACE MR-01-75





## .187 Orifice Subsea Ball Valves

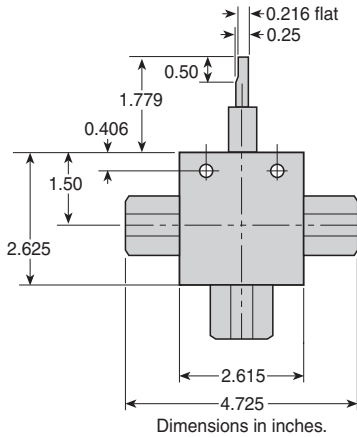

**3-Way Ball Valve**

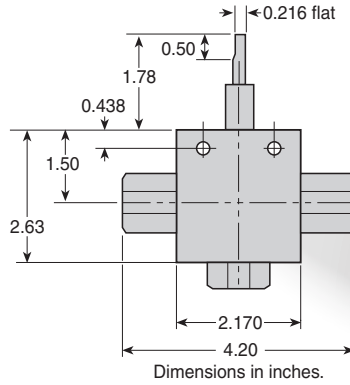

**2-Way Ball Valve**

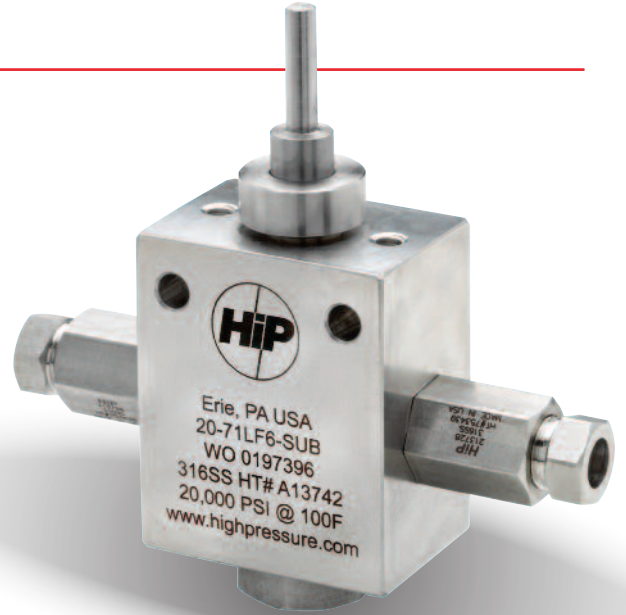

Orifice	Tube Size	Connection	Pressure Rating	Minimum Orifice	Cv	Catalog No.
3-Way 180°	3/8"	HF6	20,000 psi	0.125	0.22	20-72HF6-SUB
	1/4"	HF4	20,000 psi	0.094	0.10	20-72HF4-SUB
	9/16"	LF9	20,000 psi	0.187	0.71	20-72HF9-SUB
	3/8"	LF6	20,000 psi	0.187	0.71	20-72LF6-SUB
	1/4"	LF4	20,000 psi	0.109	0.15	20-72LF4-SUB
	3/8"	3/8" NPT	15,000 psi	0.187	0.71	15-72NFC-SUB
3-Way 90° Diverter	3/8"	HF6	20,000 psi	0.125	0.22	20-73HF6-SUB
	1/4"	HF4	20,000 psi	0.094	0.10	20-73HF4-SUB
	9/16"	LF9	20,000 psi	0.187	0.71	20-73LF9-SUB
	3/8"	LF6	20,000 psi	0.187	0.71	20-73LF6-SUB
	1/4"	LF4	20,000 psi	0.109	0.15	20-73LF4-SUB
	3/8"	3/8" NPT	15,000 psi	0.187	0.71	15-73NFC-SUB
2-Way	1/4"	1/4" NPT	15,000 psi	0.187	0.71	15-73NFB-SUB
	9/16"	HF9	20,000 psi	0.187	1.45	20-71HF9-SUB
	3/8"	HF6	20,000 psi	0.125	0.45	20-71HF6-SUB
	1/4"	HF4	20,000 psi	0.094	0.20	20-71HF4-SUB
	9/16"	LF9	20,000 psi	0.187	1.45	20-71LF9-SUB
	3/8"	LF6	20,000 psi	0.187	1.45	20-71LF6-SUB
	1/4"	LF4	20,000 psi	0.109	0.31	20-71LF4-SUB
	1/2"	1/2" NPT	15,000 psi	0.187	1.45	15-71NFD-SUB
	3/8"	3/8" NPT	15,000 psi	0.187	1.45	15-71NFC-SUB
1/4"	1/4" NPT	15,000 psi	0.187	1.45	15-71NFB-SUB	
1/8"	1/8" NPT	15,000 psi	0.187	1.45	15-71NFA-SUB	

8

# Ball Valves

## .375 Orifice Subsea Ball Valves

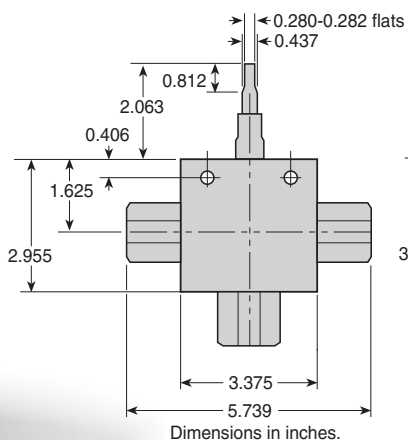
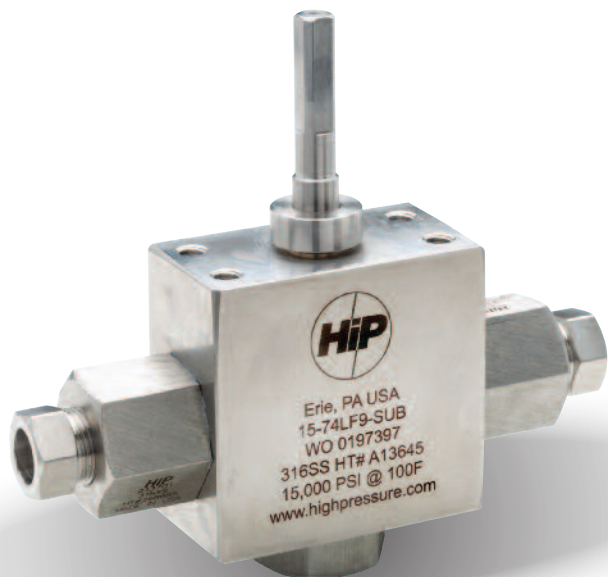

**3-Way Ball Valve**

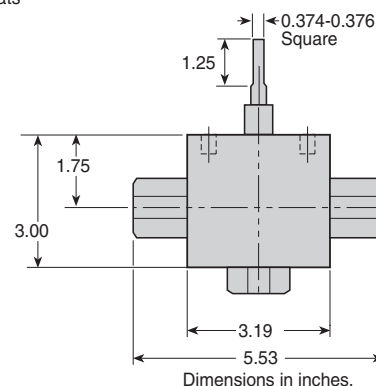

**2-Way Ball Valve**

8

Orifice	Tube Size	Connection	Pressure Rating	Minimum Orifice	Cv	Catalog No.
3-Way 180°	3/4"	LF12	15,000 psi	0.375	2.40	15-75LF12-SUB
	9/16"	LF9	15,000 psi	0.312	1.67	15-75LF9-SUB
	3/8"	LF6	15,000 psi	0.203	0.81	15-75LF6-SUB
	1/2"	1/2" NPT	15,000 psi	0.375	2.40	15-75NFD-SUB
	3/8"	3/8" NPT	15,000 psi	0.375	2.40	15-75NFC-SUB
	1/4"	1/4" NPT	15,000 psi	0.250	1.07	15-75NFB-SUB
3-Way 90° Diverter	3/4"	LF12	15,000 psi	0.375	2.40	15-76LF12-SUB
	9/16"	LF9	15,000 psi	0.312	1.67	15-76LF9-SUB
	3/8"	LF6	15,000 psi	0.203	0.81	15-76LF6-SUB
	1/2"	1/2" NPT	15,000 psi	0.375	2.40	15-76NFD-SUB
	3/8"	3/8" NPT	15,000 psi	0.375	2.40	15-76NFC-SUB
	1/4"	1/4" NPT	15,000 psi	0.250	1.07	15-76NFB-SUB
2-Way	3/4"	LF12	15,000 psi	0.375	6.08	15-74LF12-SUB
	9/16"	LF9	15,000 psi	0.312	4.22	15-74LF9-SUB
	3/8"	LF6	15,000 psi	0.203	2.20	15-74LF6-SUB
	1/2"	1/2" NPT	15,000 psi	0.375	6.08	15-74NFD-SUB
	3/8"	3/8" NPT	15,000 psi	0.375	6.08	15-74NFC-SUB
	1/4"	1/4" NPT	15,000 psi	0.250	2.70	15-74NFB-SUB

## **.500 Orifice Subsea Ball Valves**

Orifice	Tube Size	Connection	Pressure Rating	Minimum Orifice	Cv	Catalog No.
3-Way 180°	1"	1" NPT	10,000 psi	.500	4.40	10-81NFH-SUB
	3/4"	3/4" NPT	10,000 psi	.500	4.40	10-81NFF-SUB
	1"	LF16	10,000 psi	.500	4.40	10-81LF16-SUB
	3/4"	LF12	10,000 psi	.500	4.40	10-81LF12-SUB
3-Way 90° Diverter	1"	1" NPT	10,000 psi	.500	4.40	10-82NFH-SUB
	3/4"	3/4" NPT	10,000 psi	.500	4.40	10-82NFF-SUB
	1"	LF16	10,000 psi	.500	4.40	10-82LF16-SUB
	3/4"	LF12	10,000 psi	.500	4.40	10-82LF12-SUB
2-Way	1"	1" NPT	10,000 psi	.500	10.2	10-80NFH-SUB
	3/4"	3/4" NPT	10,000 psi	.500	10.2	10-80NFF-SUB
	1"	LF16	10,000 psi	.500	10.2	10-80LF16-SUB
	3/4"	LF12	10,000 psi	.500	10.2	10-80LF12-SUB

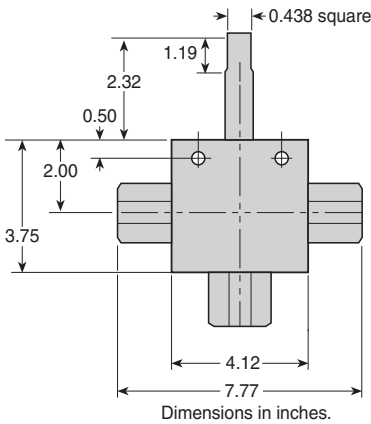

**3-Way Ball Valve**

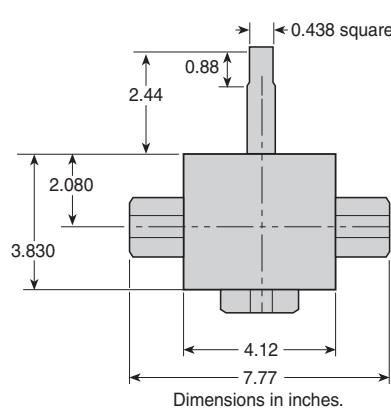

**2-Way Ball Valve**

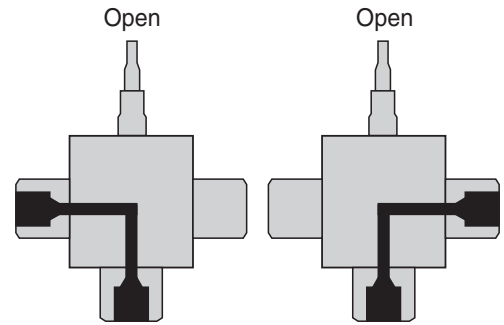

**90° Three-Way Diverter Valve**

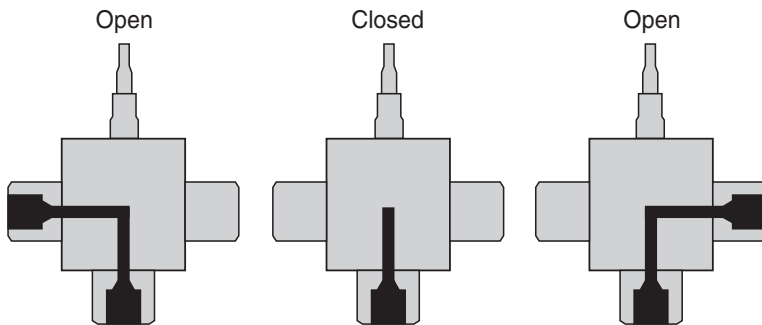

**180° Three-Way Ball Valve**

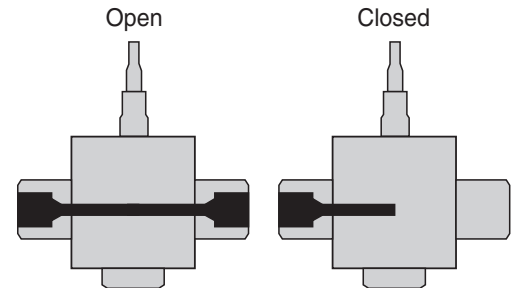

**Two-Way Valve**

**8**

# Relief Valves

## Metal Seat Relief Valves (Factory Set)

Relief valves are offered in pressure ranges: 1,500 through 60,000 psi.

**Standard materials** include 316 stainless steel bodies and removable seat glands with 17-4PH stainless steel removable stem and stem seats. Standard O-ring material on the stem is Viton Valves may be used up to 400°F.

**Inlet connections** are for  $\frac{9}{16}$ " O.D. tubing (HF9) with adapters for other sizes available. Outlet connections are  $\frac{1}{2}$ " NPT.

These valves are not recommended for use below 1,500 psi, and are not readily adjustable in the field without proper test equipment. Pressure settings are made at the factory and valves are tagged accordingly.

**To order**, simply specify catalog number and set pressure.

- Metal Seated - Catalog Number: 402633
- Minimum Temperature: 0°F
- Maximum Temperature with standard Viton O-ring: 400°F
- Maximum Temperature with Kalrez O-ring: 500°F

## Metal Seat Relief Valves (Factory Set)

Pressure Range	Orifice Size	Type of Service*	Assembly Part No.	Max Flow Capacity H <sub>2</sub> O (GPM)
1,500 to 2,999 psi	1/4"	GAS OR LIQUID	402633-03	13
3,000 to 10,999 psi	1/4"	GAS OR LIQUID	402633-10	25
11,000 to 20,999 psi	3/16"	GAS OR LIQUID	402633-20	20
21,000 to 30,000 psi	1/8"	GAS OR LIQUID	402633-30	10
30,001 to 45,000 psi	7/64"	GAS OR LIQUID	402633-45	10
45,001 to 60,000 psi	3/32"	GAS OR LIQUID	402633-60	8

\*Valves not bubble tight on gas service.

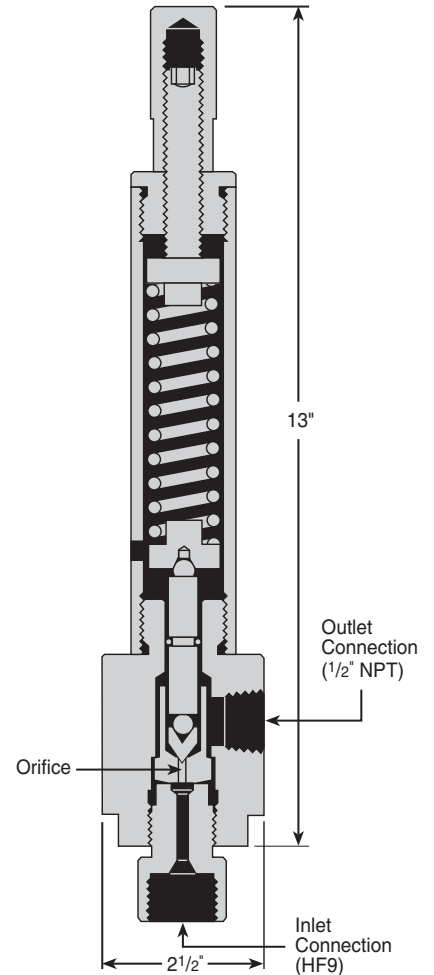

9

402633-20 Relief Valve (Factory Set)

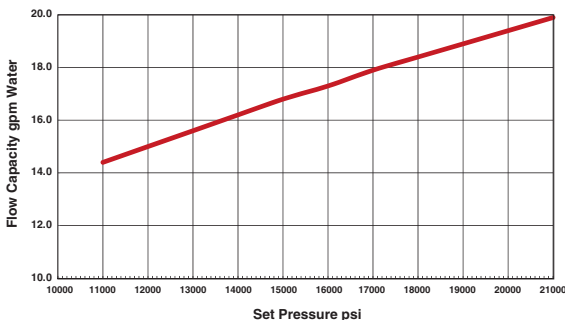

## CE Marked Relief Valves

HiP relief valves are now available with CE marking. These products will proudly be marked with the CE symbol, signifying they comply with the stringent requirements of the Pressure Equipment Directive (PED). To order, add -CE to your relief valve part number.

## Soft Seat Relief Valves (Factory Set)

Relief valves are offered in pressure ranges: 1,500 through 25,000 psi.

**Standard materials** include 316 stainless steel bodies and removable seat glands with 17-4PH stem and seal ring. Standard O-ring material on the stem is Viton. The seat material is Peek. Valves may be used up to 400°F with standard Viton O-ring or 450°F with the Kalrez O-ring option.

**Inlet connections** are for 9/16" O.D. tubing (HF9) with adapters for other sizes available. Outlet connections are 1/2" NPT. These valves are not recommended for use below 1,500 psi, and are not readily adjustable in the field without proper test equipment. Pressure settings are made at the factory and valves are tagged accordingly.

**To order**, simply specify catalog number and set pressure.

- Soft Seat - Catalog Number: 602923
- Minimum Temperature: 0°F
- Maximum Temperature standard Viton O-ring: 400°F
- Maximum Temperature with Kalrez O-ring: 450°F

## Soft Seat Relief Valves (Factory Set)

Pressure Range	Orifice Size	Type of Service	Assembly Part No.	Max Flow Capacity H <sub>2</sub> O (GPM)
1,500 to 2,999 psi	3/16"	GAS OR LIQUID	602923-03	8
3,000 to 9,999 psi	3/16"	GAS OR LIQUID	602923-10	14
10,000 to 19,999 psi	1/8"	GAS OR LIQUID	602923-20	8
20,000 to 25,000 psi	1/8"	GAS OR LIQUID	602923-25	10

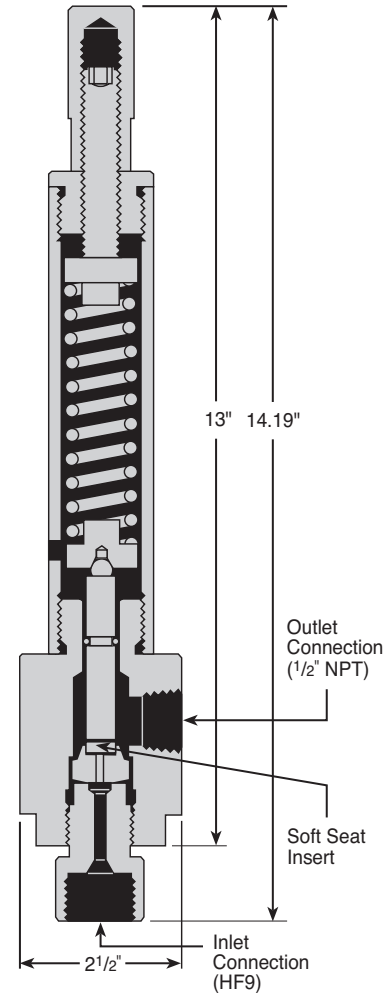
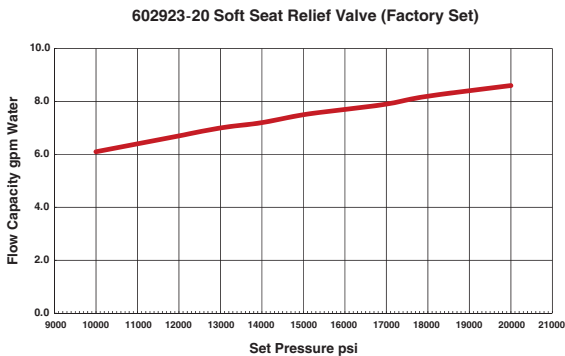

## CE Marked Relief Valves

HiP relief valves are now available with CE marking. These products will proudly be marked with the CE symbol, signifying they comply with the stringent requirements of the Pressure Equipment Directive (PED). To order, add -CE to your relief valve part number.

# Relief Valves

## Relief Valves (Field Adjustable)

Relief valves are offered in pressure ranges: 1,000 through 20,000 psi.

**Standard materials** include 316 stainless steel bodies and seat glands. Standard O-ring material is EPDM, with teflon packing and nylon seats.

**Inlet connections**  $\frac{1}{4}$ " NPT-HIP-10RV; HF4-HIP-20RV. Outlet connections are  $\frac{1}{4}$ " NPT.

These valves are not recommended for use below 1,000 psi, and are **readily** adjustable in the field.

**To order**, simply specify catalog number. Example: HIP-10RV

- Metal Seated - HIP-10RV and HIP-20RV
- Seat Material: Nylon standard, Peek optional
- Minimum Temperature: 0°F
- Maximum Temperature with standard EPDM: 350°F
- Maximum Temperature with Peek seats: 450°F
- Maximum Temperature Kalrez O-rings: 450°F

## Relief Valves (Field Adjustable)

Pressure Range	Orifice Size	Type of Service	Part number	Cv
1,000 to 10,000 psi	0.070	GAS OR LIQUID	HIP-10RV	.12
10,001 - 20,000 psi	0.070	GAS OR LIQUID	HIP-20RV	.12

HIP 10RV & HIP 20RV Relief Valves (Field Adjustable)

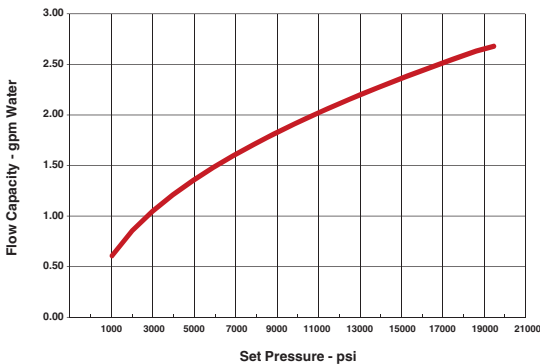

## CE Marked Relief Valves

HiP relief valves are now available with CE marking. These products will proudly be marked with the CE symbol, signifying they comply with the stringent requirements of the Pressure Equipment Directive (PED). To order, add -CE to your relief valve part number.

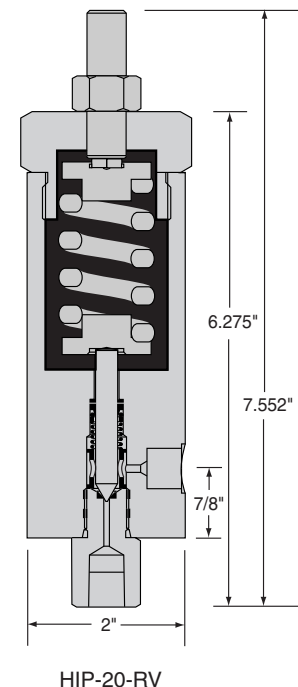
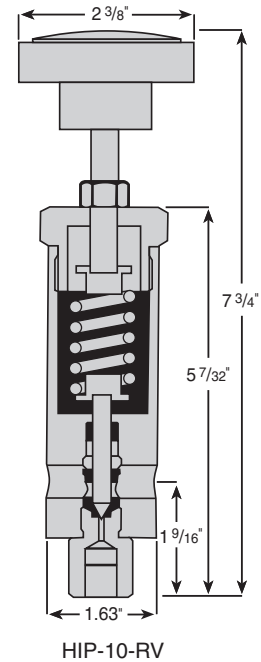

\*Please note HIP-20RV does not have handle, the valve is shipped with  $\frac{1}{2}$ -13" set screw.



## Block and Bleed Needle Valves

High Pressure Equipment offers Block and Bleed needle valves designed for calibration operations. Block and Bleed needle valves provide controlled flow to high-pressure hydraulic and pneumatic systems through both shut-off regulation and diversion. These needle valves deliver safe, reliable operation to 20,000 psi.\* Teflon packing provides dependable leak-free service up to 400°F (204°C).

- Tube sizes: 1/4", 3/8", 9/16" medium pressure and 1/4" FNPT, 3/8" FNPT, 1/2" FNPT
- Non-rotating stem design
- Type 300 stainless steel tee handles
- Teflon packing to 400°F (204°C)
- Optional wetted parts available
- Optional O-rings available

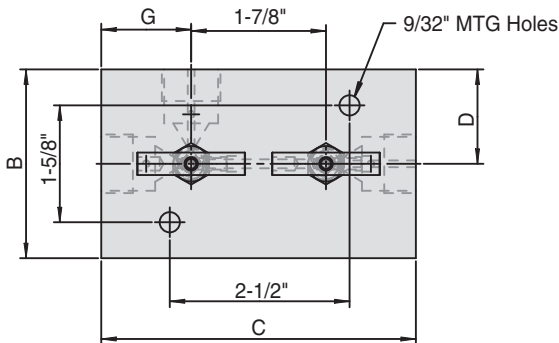
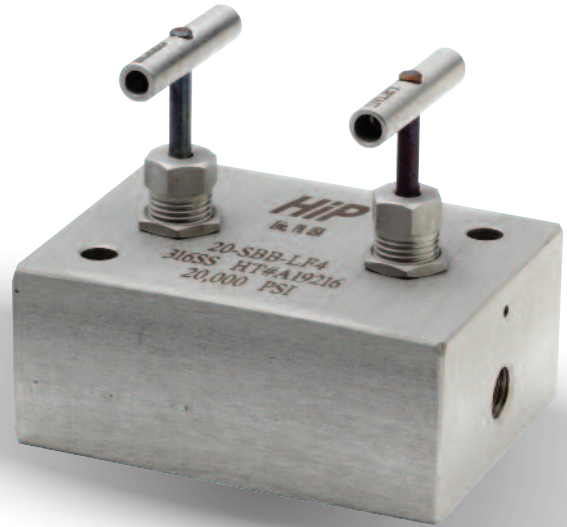

Catalog Number	Connector	A	B	C	D	E	F	G
15-SBB-NFB	1/4" NPT	1 1/2"	2 5/8"	3 7/8"	1 5/16"	7/8"	9/16"	1"
15-SBB-NFC	3/8" NPT	1 3/4"	3"	4 3/8"	1 1/2"	1 1/8"	13/16"	1 1/4"
15-SBB-NFD	1/2" NPT	1 3/4"	3"	4 3/8"	1 1/2"	1 1/8"	13/16"	1 1/4"
20-SBB-LF4	LF4	1 1/2"	2 5/8"	3 1/2"	1 5/16"	7/8"	9/16"	1 3/16"
20-SBB-LF6	LF6	1 1/2"	2 5/8"	3 3/4"	1 5/16"	7/8"	9/16"	1 5/16"
20-SBB-LF9	LF9	1 1/2"	2 5/8"	4 3/8"	1 5/16"	7/8"	9/16"	1 1/4"

**10**

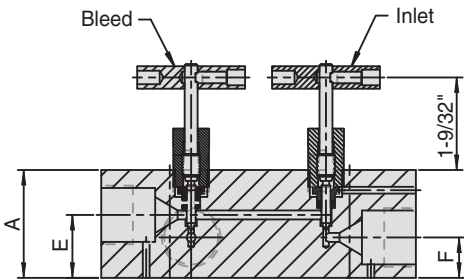

Dimensions in inches

\* NPT connection: rated 15,000 psi

# Block and Bleed Valves

## Double Block and Bleed Needle Valves

High Pressure Equipment Company introduces its Double Block and Bleed needle valves that deliver safe, reliable operation to 20,000 psi. Our valves feature coned and threaded connections for 1/4" to 1" medium pressure tubing, making them ideal for pressure monitoring and testing, chemical injection and drain line isolation applications. This valve is manufactured from cold worked stainless steel and 17-4-H1075 with 300 stainless steel tee handles and a non-rotating stem design. Teflon packing provides reliable leak-free service from 0°F (-17.8°C) to 400°F (204°C).

- Rated for service to 20,000 psi
- DBB series: 1/4" to 1" medium pressure, coned and threaded connections
- Non-rotating stem design
- Type 300 stainless steel tee handles
- Manufactured from cold worked stainless steel and 17-4-H1075
- 1/4" FNPT vent
- Teflon packing from 0°F (-17.8°C) to 400°F (204°C)
- Optional wetted parts available
- Optional PolyPak available

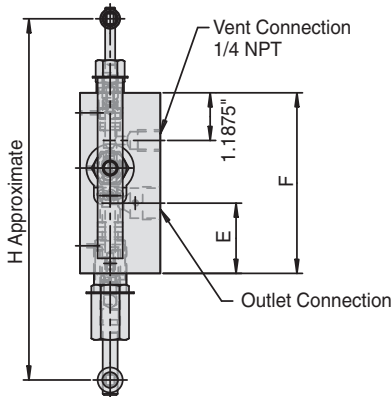
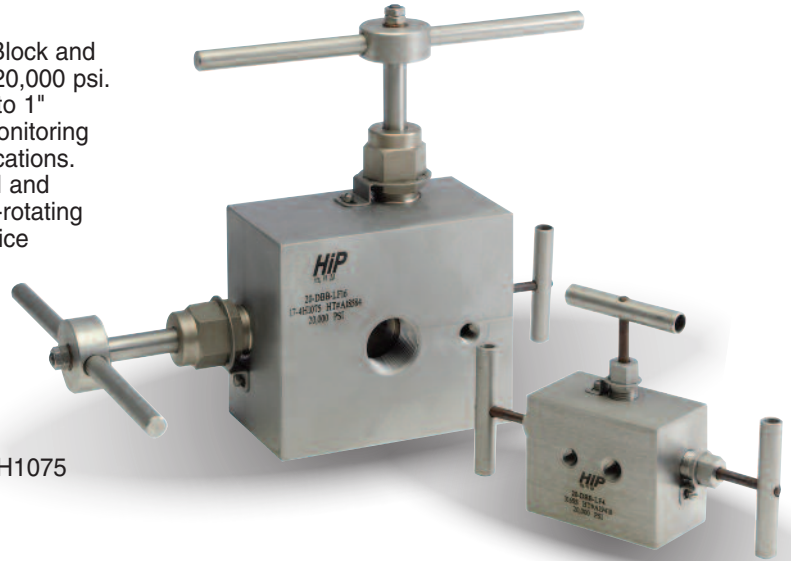

Catalog Number	Inlet Connector	Outlet Connector	A	B	C	D	E	F	G	H	K
20-DBB-LF4	LF4	LF4	2"	1 1/4"	1 3/16"	2 3/4"	1 3/16"	3 1/2"	4 5/8"	7 3/16"	3"
20-DBB-LF6	LF6	LF6	2"	1 1/4"	1 3/16"	2 3/4"	1 3/16"	3 1/2"	4 5/8"	7 3/16"	3"
20-DBB-LF9	LF9	LF9	2"	1 1/4"	1 3/4"	3 3/8"	1 3/4"	4 1/2"	6 1/16"	9"	4 1/2"
20-DBB-LF12	LF12	LF12	2 1/2"	1 3/4"	2 1/4"	4 1/4"	2 1/4"	5"	6 7/8"	9 1/2"	8 3/4"
20-DBB-LF16	LF16	LF16	3 1/2"	2 1/2"	2 13/16"	5 1/4"	2 13/16"	6"	8 7/16"	11"	10 1/4"

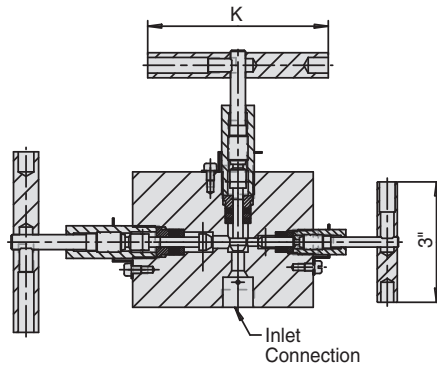

Dimensions in inches

10

## Double Block and Bleed Ball Valves

High Pressure Equipment has designed a trunion style block and bleed ball valve for calibration applications to 15,000 psi. This reliable ball valve is an excellent method to block and bleed high pressure hydraulic and pneumatic systems used for pressure monitoring and test, chemical injection and drain line isolation. This is a full port, quarter turn double ball valve.

- Trunion style closure, ideal for severe service applications
- .203", .250", .313" and .375" orifices
- Tube sizes:  $\frac{3}{8}$ ",  $\frac{9}{16}$ ",  $\frac{3}{4}$ ",  $\frac{1}{4}$ " NPT,  $\frac{3}{8}$ " NPT and  $\frac{1}{2}$ " NPT
- 316 stainless steel construction
- Viton O-rings
- PEEK ball seats provide excellent environmental and chemical resistance
- Optional O-rings, wetted parts and materials of construction available
- Double positive isolation
- Vent port is  $\frac{1}{4}$ " FNPT

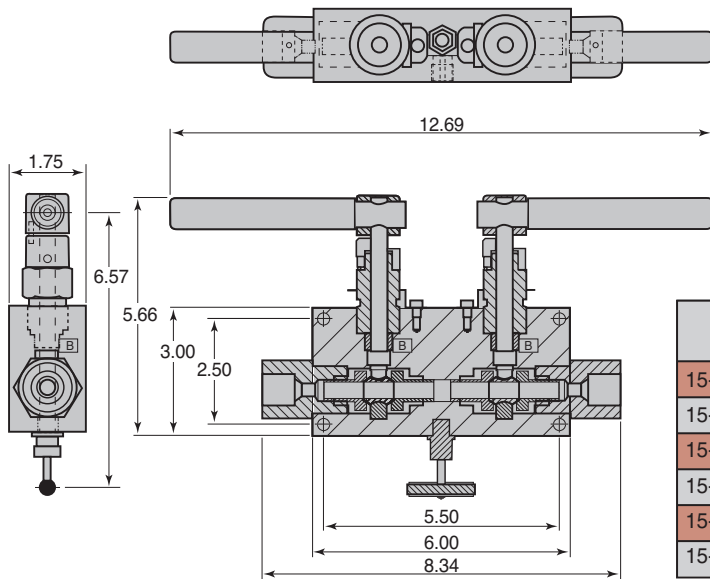

Dimensions in inches

Catalog Number	Tube Size	Connector	Pressure Rating	Minimun Orifice	C <sub>v</sub>
15-DBB-BV-NFD	$\frac{1}{2}$ " NPT	NFD	15,000	.375	6.08
15-DBB-BV-NFC	$\frac{3}{8}$ " NPT	NFC	15,000	.375	6.08
15-DBB-BV-NFB	$\frac{1}{4}$ " NPT	NFB	15,000	.250	2.70
15-DBB-BV-LF12	$\frac{3}{4}$ "	LF12	15,000	.375	6.08
15-DBB-BV-LF9	$\frac{9}{16}$ "	LF9	15,000	.313	4.22
15-DBB-BV-LF6	$\frac{3}{8}$ "	LF6	15,000	.203	2.01

10



# High Pressure Equipment

---

## Oil and Gas Products

Since 1954, HiP has been designing and manufacturing the highest quality and most dependable high pressure products for oil and gas applications. Our ISO 9001 certified operation is part of a quality focus that has helped us gain the trust of many oil and gas industry leaders. And our on-time delivery and competitive pricing have made us integral partners in our customers' cost-reduction efforts.

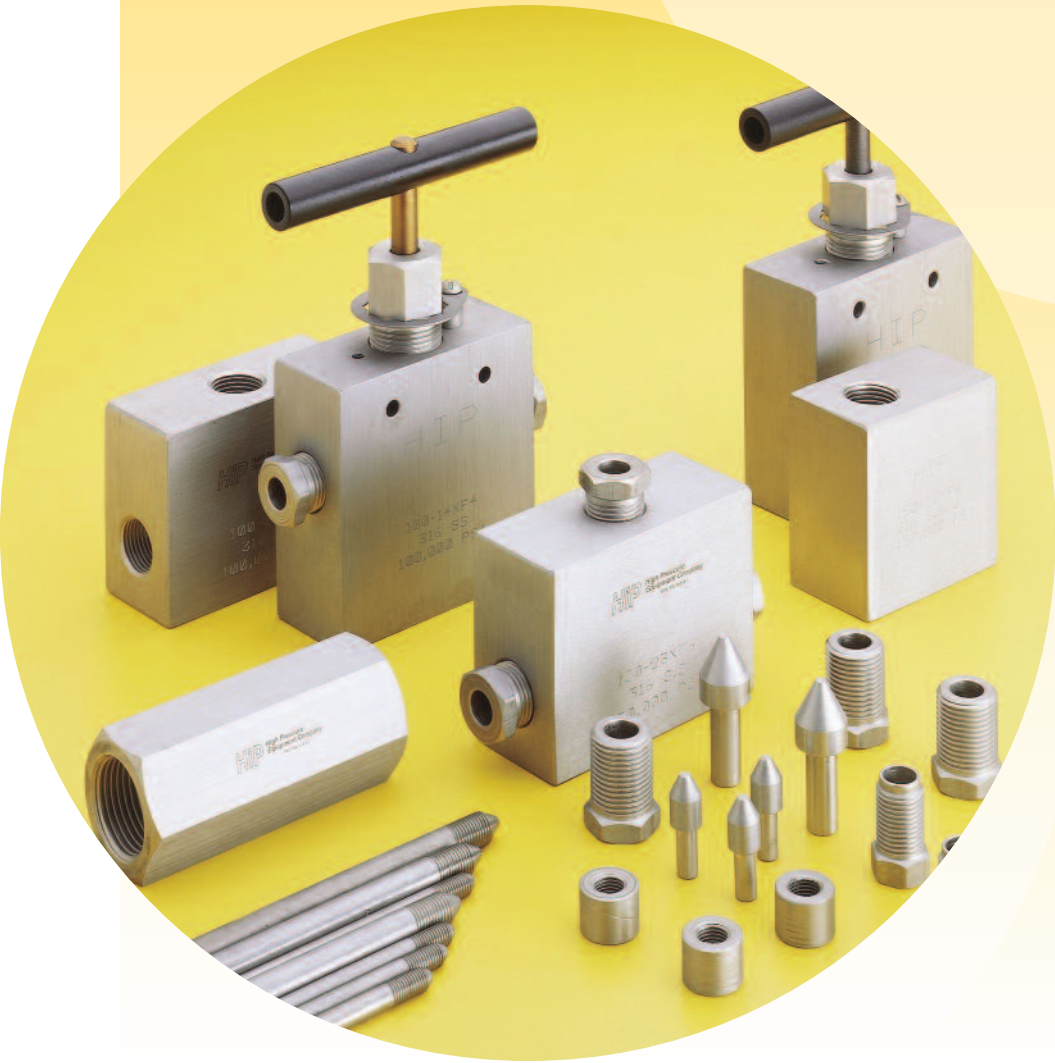

### **Index**

---

Sour Oil and Gas Valves . . . . .	85-86
Fittings . . . . .	87
Bulkheads, Caps, Line Filters & Check Valves . . . . .	88
Adapters & Tubing . . . . .	89
Coned & Threaded Nipples . . . . .	89
Wellhead Gauge & Bleed Valves . . .	90

## Sour Oil & Gas Valves

High Pressure Equipment Company has developed a complete line of valves and affiliated components specifically for the unique requirements of the oil and gas industry. We offer valves, fittings and tubing for use with sour oil and gas (H<sub>2</sub>S) in a 10,000 psi, 20,000 psi and 30,000 psi series. Our "SGS" products are constructed of annealed 316 stainless steel and meet or exceed all requirements of NACE MR0175 and the American Petroleum Institute. For those applications where H<sub>2</sub>S is not present, our standard line of valves, fittings and tubing will accommodate pressures to 150,000 psi.



## Hastelloy & Other Exotic Material Products in Stock

We know that some oil and gas applications demand material performance beyond our "SGS" stainless steel products. In an effort to provide our customers with their material of choice and meet tight shipping deadlines, we maintain an inventory of Hastelloy and Monel valves and fittings.

## Sour Oil & Gas Valves

- 1/4", 3/8" & 9/16" O.D. tube connections
- 10,000, 20,000 & 30,000 psi series
- Vee and regulating stem types
- Annealed 316 stainless steel construction
- Meet or exceed requirements of NACE MR0175

## High Pressure Coned and Threaded Connections

HiP oil field products use a high pressure coned and threaded connection which accommodates the high temperatures, high pressures and extreme conditions common in these applications. These connections may be disassembled and retightened indefinitely.

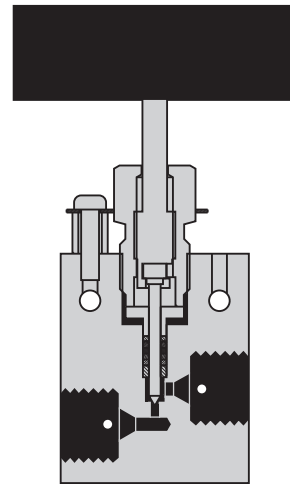

HF4 (1/4"), HF6 (3/8") and HF9 (9/16")

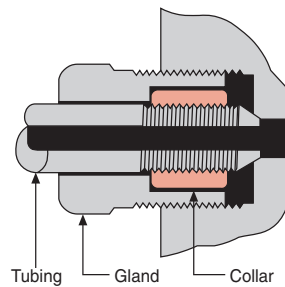



# Oil and Gas Products

## Two Way Straight Valves

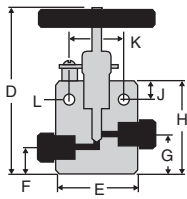

Tubing	Catalog No.	psi	Connection	Orifice	D	E	F	G	H	J	K	L	Thickness
1/4" O.D.	30-11HF4-SGS	20,000	HF4	3/32"	5 3/16"	2"	5/8"	1"	2 7/16"	1/2"	1 3/8"	7/32"	1"
3/8" O.D.	30-11HF6-SGS	20,000	HF6	1/8"	5 3/16"	2"	5/8"	1"	2 7/16"	1/2"	1 3/8"	7/32"	1"
9/16" O.D.	30-11HF9-SGS	20,000	HF9	1/8"	5 5/8"	2 5/8"	1"	1 7/16"	2 7/8"	1/2"	1 3/8"	7/32"	1 1/2"
1/4" O.D.	60-11HF4-SGS	30,000	HF4	1/16"	5 3/16"	2"	5/8"	1"	2 7/16"	1/2"	1 3/8"	7/32"	1"
3/8" O.D.	60-11HF6-SGS	30,000	HF6	1/16"	5 3/16"	2"	5/8"	1"	2 7/16"	1/2"	1 3/8"	7/32"	1"
9/16" O.D.	60-11HF9-SGS	30,000	HF9	1/16"	5 5/8"	2 5/8"	1"	1 7/16"	2 7/8"	1/2"	1 3/8"	7/32"	1 1/2"

## Two Way Angle Valves

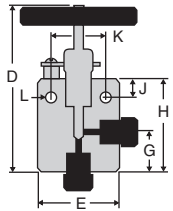

Tubing	Catalog No.	psi	Connection	Orifice	D	E	F	G	H	J	K	L	Thickness
1/4" O.D.	30-12HF4-SGS	20,000	HF4	3/32"	5 3/16"	2"	—	1"	2 7/16"	1/2"	1 3/8"	7/32"	1"
3/8" O.D.	30-12HF6-SGS	20,000	HF6	1/8"	5 3/16"	2"	—	1 3/8"	2 13/16"	1/2"	1 3/8"	7/32"	1"
9/16" O.D.	30-12HF9-SGS	20,000	HF9	1/8"	5 5/8"	2 5/8"	—	1 7/16"	2 7/8"	1/2"	1 3/8"	7/32"	1 1/2"
1/4" O.D.	60-12HF4-SGS	30,000	HF4	1/16"	5 3/16"	2"	—	1"	2 7/16"	1/2"	1 3/8"	7/32"	1"
3/8" O.D.	60-12HF6-SGS	30,000	HF6	1/16"	5 3/16"	2"	—	1 3/8"	2 13/16"	1/2"	1 3/8"	7/32"	1"
9/16" O.D.	60-12HF9-SGS	30,000	HF9	1/16"	5 5/8"	2 5/8"	—	1 7/16"	2 7/8"	1/2"	1 3/8"	7/32"	1 1/2"

## Three Way Valves / Two Pressure Connections

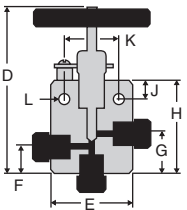

Tubing	Catalog No.	psi	Connection	Orifice	D	E	F	G	H	J	K	L	Thickness
1/4" O.D.	30-13HF4-SGS	20,000	HF4	3/32"	5 3/16"	2"	5/8"	1"	2 7/16"	1/2"	1 3/8"	7/32"	1"
3/8" O.D.	30-13HF6-SGS	20,000	HF6	1/8"	5 3/16"	2"	1"	1 3/8"	2 13/16"	1/2"	1 3/8"	7/32"	1"
9/16" O.D.	30-13HF9-SGS	20,000	HF9	1/8"	6 1/16"	2 5/8"	1 7/16"	1 7/8"	3 5/16"	1/2"	1 3/8"	7/32"	1 1/2"
1/4" O.D.	60-13HF4-SGS	30,000	HF4	1/16"	5 3/16"	2"	5/8"	1"	2 7/16"	1/2"	1 3/8"	7/32"	1"
3/8" O.D.	60-13HF6-SGS	30,000	HF6	1/16"	5 3/16"	2"	1"	1 3/8"	2 13/16"	1/2"	1 3/8"	7/32"	1"
9/16" O.D.	60-13HF9-SGS	30,000	HF9	1/16"	6 1/16"	2 5/8"	1 7/16"	1 7/8"	2 5/16"	1/2"	1 3/8"	7/32"	1 1/2"

## Three Way Valves / One Pressure Connection

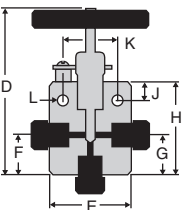

Tubing	Catalog No.	psi	Connection	Orifice	D	E	F	G	H	J	K	L	Thickness
1/4" O.D.	30-14HF4-SGS	20,000	HF4	3/32"	5 3/16"	2"	1"	1"	2 7/16"	1/2"	1 3/8"	7/32"	1"
3/8" O.D.	30-14HF6-SGS	20,000	HF6	1/8"	5 3/16"	2"	2"	1 7/16"	2 13/16"	1/2"	1 3/8"	7/32"	1"
9/16" O.D.	30-14HF9-SGS	20,000	HF9	1/8"	5 5/8"	2 5/8"	2 3/16"	1 7/16"	2 7/8"	1/2"	1 3/8"	7/32"	1 1/2"
1/4" O.D.	60-14HF4-SGS	30,000	HF4	1/16"	5 3/16"	2"	1"	1"	2 7/16"	1/2"	1 3/8"	7/32"	1"
3/8" O.D.	60-14HF6-SGS	30,000	HF6	1/16"	5 3/16"	2"	1 3/8"	1 3/8"	2 13/16"	1/2"	1 3/8"	7/32"	1"
9/16" O.D.	60-14HF9-SGS	30,000	HF9	1/16"	5 5/8"	2 5/8"	1 7/16"	1 7/8"	2 7/8"	1/2"	1 3/8"	7/32"	1 1/2"

## Three Way / Two Stem Connection Valves

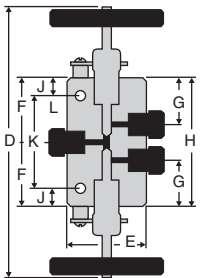

Tubing	Catalog No.	psi	Connection	Orifice	D	E	F	G	H	J	K	L	Thickness
1/4" O.D.	30-15HF4-SGS	20,000	HF4	3/32"	9 1/4"	2"	1"	1 7/16"	3 3/4"	1/2"	2 3/4"	7/32"	1"
3/8" O.D.	30-15HF6-SGS	20,000	HF6	1/8"	9 1/2"	2"	2"	1 7/16"	4"	1/2"	3"	7/32"	1"
9/16" O.D.	30-15HF9-SGS	20,000	HF9	1/8"	9 7/8"	2 5/8"	2 3/16"	1 7/16"	4 3/8"	1/2"	3 3/8"	7/32"	1 1/2"
1/4" O.D.	60-15HF4-SGS	30,000	HF4	1/16"	9 1/4"	2"	1"	1 7/16"	3 3/4"	1/2"	2 3/4"	7/32"	1"
3/8" O.D.	60-15HF6-SGS	30,000	HF6	1/16"	9 1/2"	2"	2"	1 7/16"	4"	1/2"	3"	7/32"	1"
9/16" O.D.	60-15HF9-SGS	30,000	HF9	1/16"	9 7/8"	2 5/8"	2 3/16"	1 7/16"	4 3/8"	1/2"	3 3/8"	7/32"	1 1/2"

## Replaceable Seat Valves

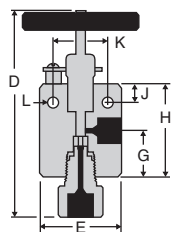



Tubing	Catalog No.	psi	Connection	Orifice	D	E	F	G	H	J	K	L	Thickness
1/4" O.D.	30-12HF4-R-SGS	20,000	HF4	3/32"	5 3/16"	2"	—	1"	2 7/16"	1/2"	1 3/8"	7/32"	1"
3/8" O.D.	30-12HF6-R-SGS	20,000	HF6	1/8"	5 3/16"	2"	—	1 3/8"	2 13/16"	1/2"	1 3/8"	7/32"	1"
9/16" O.D.	30-12HF9-R-SGS	20,000	HF9	1/8"	5 5/8"	2 5/8"	—	1 7/16"	2 7/8"	1/2"	1 3/8"	7/32"	1 1/2"
1/4" O.D.	60-12HF4-R-SGS	30,000	HF4	1/16"	5 3/16"	2"	—	1"	2 7/16"	1/2"	1 3/8"	7/32"	1"
3/8" O.D.	60-12HF6-R-SGS	30,000	HF6	1/16"	5 3/16"	2"	—	1 3/8"	2 13/16"	1/2"	1 3/8"	7/32"	1"
9/16" O.D.	60-12HF9-R-SGS	30,000	HF9	1/16"	5 5/8"	2 5/8"	—	1 7/16"	2 7/8"	1/2"	1 3/8"	7/32"	1 1/2"



## Glands/Sleeves/Plugs/Elbows/Tees/Crosses

A complete range of elbows, tees, and crosses is available for use with sour oil and gas. Material is annealed 316 stainless steel. All connection components and fittings are rated for 30,000 psi service. Standard tubing collars and glands are provided unless otherwise specified.

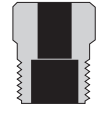
### Connection Components

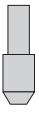
Catalog No.	Tube Size	Gland	Catalog No.	Tube Size	Collar	Catalog No.	Tube Size	Plug
60-2HM4-SGS	1/4"		60-2H4-SGS	1/4"		60-7HM4-SGS	1/4"	
60-2HM6-SGS	3/8"		60-2H6-SGS	3/8"		60-7HM6-SGS	3/8"	
60-2HM9-SGS	9/16"		60-2H9-SGS	9/16"		60-7HM9-SGS	9/16"	

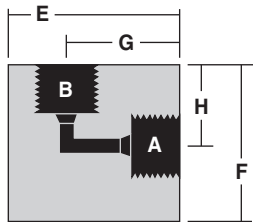

### High Pressure Elbows

Catalog No.	Pressure Rating psi	Connections	A-B	E	F	G	H	Thickness
60-22HF4-SGS	30,000	1/4" O.D. TUBE	HF4	1 3/8"	1 1/2"	7/8"	1"	1"
60-22HF6-SGS	30,000	3/8" O.D. TUBE	HF6	1 3/4"	1 1/2"	1 1/4"	1"	1"
60-22HF9-SGS	30,000	9/16" O.D. TUBE	HF9	2 5/8"	1 7/8"	1 7/8"	1 1/8"	1 1/2"

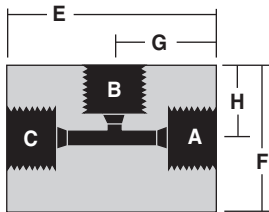

### High Pressure Tees

Catalog No.	Pressure Rating psi	Connections	A-B-C	E	F	G	H	Thickness
60-23HF4-SGS	30,000	1/4" O.D. TUBE	HF4	2"	1 3/8"	1"	7/8"	1"
60-23HF6-SGS	30,000	3/8" O.D. TUBE	HF6	2"	1 9/16"	1"	1 1/16"	1"
60-23HF9-SGS	30,000	9/16" O.D. TUBE	HF9	2 5/8"	2 1/8"	1 5/8"	1 3/8"	1 1/2"

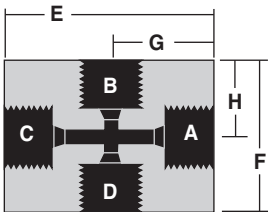

### High Pressure Crosses

Catalog No.	Pressure Rating psi	Connections	A-B-C-D	E	F	G	H	Thickness
60-24HF4-SGS	30,000	1/4" O.D. TUBE	HF4	2"	1 1/2"	1"	3/4"	1"
60-24HF6-SGS	30,000	3/8" O.D. TUBE	HF6	2 1/8"	2"	1 1/16"	1"	1"
60-24HF9-SGS	30,000	9/16" O.D. TUBE	HF9	2 3/4"	2 5/8"	1 3/8"	1 5/16"	1 1/2"

## Union Couplings (Slip Type)

Union (slip Type) couplings are ideal for use in confined space installations. This design allows the entire coupling to be disconnected and slipped back over the tubing to facilitate assembly and disassembly. In installations where tubing is easily assembled, it is preferable (and less expensive) to use standard straight couplings (see Accessories section). Sour oil and gas material is annealed 316 stainless steel. Standard tubing collars and glands are provided unless otherwise specified.

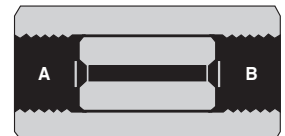

Catalog No.	Pressure Rating psi	Connections	A	B	Length	Hex Size
60-21HF4-U-SGS	30,000	1/4" O.D. TUBING	HF4	HF4	1 3/4"	1"
60-21HF6-U-SGS	30,000	3/8" O.D. TUBING	HF6	HF6	2"	1"
60-21HF9-U-SGS	30,000	9/16" O.D. TUBING	HF9	HF9	2 3/8"	1 3/8"

# Oil and Gas Products

## Bulkhead Couplings

Bulkhead couplings are designed specifically for passing a tubing connection through a panel or steel barricade. These couplings include a locknut as shown. Material is annealed 316 stainless steel. Standard tubing collars and glands are included unless otherwise specified.

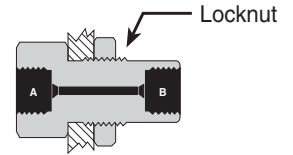

Catalog No.	Pressure Rating psi	Connections	Panel Hole	A	B	Length	Hex Size	Outside Thread	Max Panel Thickness
60-21HF4-B-SGS	30,000	1/4" O.D. TUBING	15/16"	HF4	HF4	2"	1"	7/8" - 14	7/16"
60-21HF6-B-SGS	30,000	3/8" O.D. TUBING	1 1/8"	HF6	HF6	2 3/8"	1 3/8"	1 1/16" - 12	5/8"
60-21HF9-B-SGS	30,000	9/16" O.D. TUBING	1 11/16"	HF9	HF9	2 3/4"	1 7/8"	1 5/8" - 12	7/16"

## Caps

Tubing end caps are offered for use in sealing off tubing ends either for temporary use or permanent use such as on small volume reservoirs. Standard material is annealed 316 stainless steel. Standard tubing collars and glands are provided unless otherwise specified.

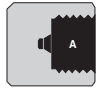

Catalog No.	Pressure Rating psi	Connections	A	Length	Hex Size
60-21HF4-C-SGS	30,000	1/4" O.D. TUBING	HF4	7/8"	3/4"
60-21HF6-C-SGS	30,000	3/8" O.D. TUBING	HF6	1 1/4"	1"
60-21HF9-C-SGS	30,000	9/16" O.D. TUBING	HF9	1 1/2"	1 3/8"

## Line Filters

The line filters as shown utilize sintered stainless steel filter discs 3 pc./set. Porosities are available as per the chart to the right. If not otherwise specified, 100 micron filter discs are supplied. (One micron = 0.001 millimeters). Material of bodies and end covers is annealed 316 stainless steel. Standard tubing glands and collars are provided unless otherwise specified.

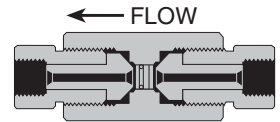

Catalog No.	Pressure Rating psi	Connections	Length	Hex Size	Micron Size Filter Available					
					0.5	2	5	10	40	100
60F-51HF4-SGS	30,000	1/4" HIGH PRESSURE	5 1/4"	1 1/2"	●	●	●	●	●	●
60F-51HF6-SGS	30,000	3/8" HIGH PRESSURE	5 1/4"	1 1/2"	●	●	●	●	●	●
60F-51HF9-SGS	30,000	9/16" HIGH PRESSURE	5 1/4"	1 1/2"	●	●	●	●	●	●

## Ball Check Valves

Ball type check valves insure flow in one direction only. Material for bodies and covers is annealed 316 stainless steel, the ball is 17-4PH. Standard tubing glands and collars are provided unless otherwise specified.

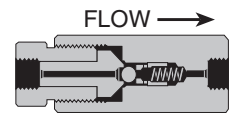

Catalog No.	psi	Connections	Length	Hex
60-41HF4-SGS	30,000	1/4" HIGH PRESSURE	4 1/4"	1 1/2"
60-41HF6-SGS	30,000	3/8" HIGH PRESSURE	4 5/8"	1 1/2"
60-41HF9-SGS	30,000	9/16" HIGH PRESSURE	5 1/8"	1 1/2"

## Soft Seat Check Valves

Soft seat check valves insure flow in one direction only and can be mounted in any position. These are highly reliable for both gas and liquid service. Standard O-ring (soft seat) material for the sealing surface is Buna-N (nitrile) with other materials including Teflon and Viton available on request. Temperature is limited by the choice of O-ring material. Material of all other parts is annealed 316 stainless steel. Standard glands and collars are provided unless otherwise specified.

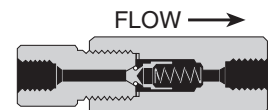

Catalog No.	psi	Connections	Length	Hex
30-41HF4-T-SGS	20,000	1/4" HIGH PRESSURE	3 7/8"	1"
30-41HF6-T-SGS	20,000	3/8" HIGH PRESSURE	3 7/8"	1"
30-41HF9-T-SGS	20,000	9/16" HIGH PRESSURE	4 1/4"	1 3/8"
60-41HF4-T-SGS	30,000	1/4" HIGH PRESSURE	4 9/16"	1 1/2"
60-41HF6-T-SGS	30,000	3/8" HIGH PRESSURE	4 9/16"	1 1/2"
60-41HF9-T-SGS	30,000	9/16" HIGH PRESSURE	5 1/16"	1 1/2"

## Adapters

Connect different sizes of tubing or tubing and pipe with our female-to-female couplings, female-to-male adapters, male-to-male adapters, reducer couplings and thermocouple adapters. For complete adapter information, see Accessories section.

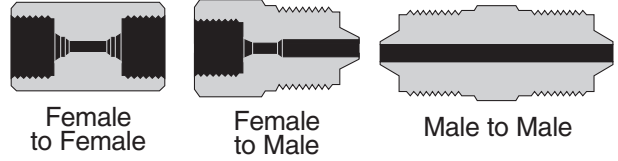

## Tubing

For sour gas applications, our tubing is annealed stainless steel, available for all standard valve and fitting sizes, and in any length specified.

For sweet applications, HiP tubing is cold drawn, seamless and supplied in the hard condition (not annealed). Tubing is stocked in lengths of 18 to 22 feet but may be ordered in true tubing lengths with **no additional cutting charge**.

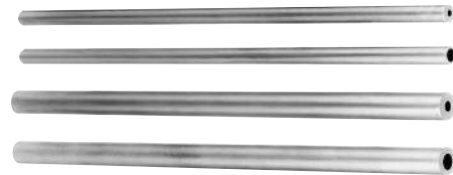

	Tubing Size	Working Pressure psi	Type of Connection Used	Material	Catalog Order Number
<b>1/4"</b>	1/4" O.D. x 0.083" I.D.	30,000	1/4" HIGH PRESSURE (HF4)	316 SS	60-9H4-316-SGS
				304 SS	60-9H4-304-SGS
<b>3/8"</b>	3/8" O.D. x 1/8" I.D.	30,000	3/8" HIGH PRESSURE (HF6)	316 SS	60-9H6-316-SGS
				304 SS	60-9H6-304-SGS
<b>9/16"</b>	9/16" O.D. x 3/16" I.D.	30,000	9/16" HIGH PRESSURE (HF9)	316 SS	60-9H9-316-SGS
				304 SS	60-9H9-304-SGS

## Coned and Threaded Nipples

Connection-ready nipples are available in annealed and standard tubing for all valve and fitting sizes, and in any length specified. Nipples are not furnished with collars and glands, unless specified at time of order. Sour gas nipples are annealed 316 SS.



Length ↓	Tubing Size (O.D. x I.D.)		
	1/4" x 0.083"	3/8" x 1/8"	9/16" x 3/16"
psi →	30,000 psi	30,000 psi	30,000 psi
2 3/4"	60-HM4-2.75-SGS		
3"		60-HM6-3-SGS	
4"			60-HM9-4-SGS
6"	60-HM4-6-SGS	60-HM6-6-SGS	60-HM9-6-SGS
8"	60-HM4-8-SGS	60-HM6-8-SGS	60-HM9-8-SGS
10"	60-HM4-10-SGS	60-HM6-10-SGS	60-HM9-10-SGS
12"	60-HM4-12-SGS	60-HM6-12-SGS	60-HM9-12-SGS

# Oil and Gas Products

## Wellhead Gauge Valves

- One inlet and three outlet ports
- Packing located below stem threads
- Metal-to-metal seat for bubble tight shut-off
- Two piece non-rotating stem for standard service valves
- One piece stem for sour gas service
- Designed for line sampling or instrument calibration

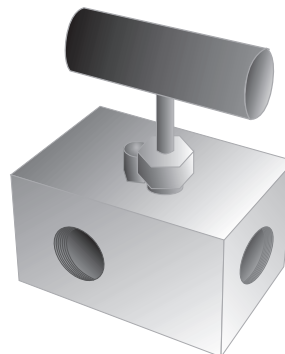

Catalog No.	Pressure Rating psi	Service	Connections	Material	Inlet Port	Outlet Port
30GVHF9	30,000	Standard	3/16" HIGH PRESSURE	316 SS	HF9	HF9
30GVHF9-SGS	20,000	H <sub>2</sub> S		Annealed 316 SS		

## Bleed Valves

- Tee handle for easy operation
- Vent port tapped for safe plumbing
- Positive blow-out prevention on stem
- Metal-to-metal seat for bubble tight shut-off
- One piece hex construction for easy installation
- Compatible with standard API test and gauge connections for 20,000 psi
- Designed for pressure bleeding



Catalog No.	Pressure Rating psi	Service	Connections	Material	Inlet Port	Outlet Port
30BVHM9	30,000	Standard	3/16" HIGH PRESSURE	316 SS	HM9	NFA
30BVHM9-SGS	20,000	H <sub>2</sub> S	x 1/8" Female NPT	Annealed 316 SS		



# High Pressure Equipment

## Accessories

High Pressure Equipment Company offers an extensive selection of accessory components to enable you to completely plumb a fluid system. These accessories allow you to move from tube to tube, tube to pipe, facilitate system pressure changes and monitor the temperatures and pressures within your system.

**Adapters** are available in both female to male and male to male configurations. Adapter models exist for all HiP connections and in the various pressure ranges to complement our valve and fitting lines.

**Couplings** enable you to make a wide variety of female to female connections. As with our adapters, couplings accommodate our complete line of valves and fittings. In addition, reducer couplings allow you to reduce line size within a given pressure range.

**Thermocouple adapters** are an excellent method to provide for temperature measurement in pressure systems up to 15,000 psi.

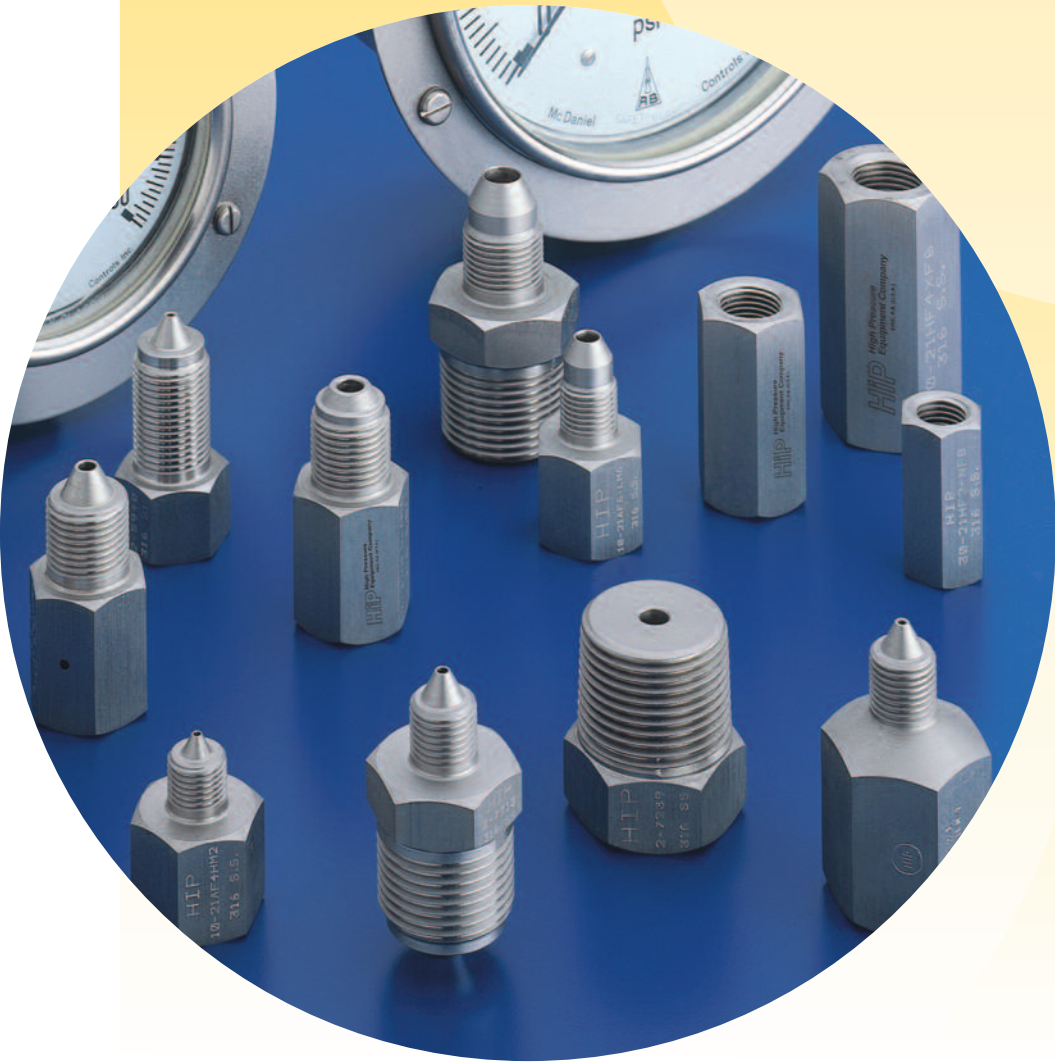

## Index

### Selection Guide:

Female to Female Couplings . . .	.92-93
Female to Male Adapters . . . . .	.94-95
Male to Male Adapters . . . . .	.96-97

### Adapters:

Female to Male . . . . .	.98-104
--------------------------	---------

### Adapters:

Male to Male . . . . .	.105-108
------------------------	----------

### Fittings:

NPT . . . . .	.109-110
Hose . . . . .	.111-112

### Couplings:

Female to Female . . . . .	.113-117
----------------------------	----------

Thermocouple Adapters . . . . .	.118
---------------------------------	------

# Accessories

## Coupling Selection Guide

**Female to Female**



		AF1	AF2	AF4	AF6
		$\frac{1}{16}$ " Taper Seal	$\frac{1}{8}$ " Taper Seal	$\frac{1}{4}$ " Taper Seal	$\frac{3}{8}$ " Taper Seal
$\frac{1}{16}$ " TAPER SEAL	AF1	15-21AF1	15-21AF1AF2	10-21AF1AF4	10-21AF1AF6
$\frac{1}{8}$ " TAPER SEAL	AF2	15-21AF1AF2	15-21AF2	10-21AF2AF4	10-21AF2AF6
$\frac{1}{4}$ " TAPER SEAL	AF4	10-21AF1AF4	10-21AF2AF4	10-21AF4	10-21AF4AF6
$\frac{3}{8}$ " TAPER SEAL	AF6	10-21AF1AF6	10-21AF2AF6	10-21AF4AF6	10-21AF6
$\frac{1}{4}$ " MEDIUM PRESSURE	LF4	15-21AF1LF4	15-21AF2LF4	10-21AF4LF4	10-21AF6LF4
$\frac{3}{8}$ " MEDIUM PRESSURE	LF6	15-21AF1LF6	15-21AF2LF6	10-21AF4LF6	10-21AF6LF6
$\frac{9}{16}$ " MEDIUM PRESSURE	LF9	15-21AF1LF9	15-21AF2LF9	10-21AF4LF9	10-21AF6LF9
$\frac{3}{4}$ " MEDIUM PRESSURE	LF12	15-21AF1LF12	15-21AF2LF12	10-21AF4LF12	10-21AF6LF12
1" MEDIUM PRESSURE	LF16	15-21AF1LF16	15-21AF2LF16	10-21AF4LF16	10-21AF6LF16
$\frac{1}{8}$ " HIGH PRESSURE	HF2	15-21AF1HF2	15-21AF2HF2	10-21AF4HF2	10-21AF6HF2
$\frac{1}{4}$ " HIGH PRESSURE	HF4	15-21AF1HF4	15-21AF2HF4	10-21AF4HF4	10-21AF6HF4
$\frac{3}{8}$ " HIGH PRESSURE	HF6	15-21AF1HF6	15-21AF2HF6	10-21AF4HF6	10-21AF6HF6
$\frac{9}{16}$ " HIGH PRESSURE	HF9	15-21AF1HF9	15-21AF2HF9	10-21AF4HF9	10-21AF6HF9
1" HIGH PRESSURE	HF16	15-21AF1HF16	15-21AF2HF16	10-21AF4HF16	10-21AF6HF16
$\frac{1}{4}$ " ULTRA HIGH PRESSURE	XF4	15-21AF1XF4	15-21AF2XF4	10-21AF4XF4	10-21AF6XF4
$\frac{3}{8}$ " ULTRA HIGH PRESSURE	XF6	15-21AF1XF6	15-21AF2XF6	10-21AF4XF6	10-21AF6XF6
$\frac{1}{8}$ " NPT PIPE	NFA	15-21AF1NFA	15-21AF2NFA	10-21AF4NFA	10-21AF6NFA
$\frac{1}{4}$ " NPT PIPE	NFB	15-21AF1NFB	15-21AF2NFB	10-21AF4NFB	10-21AF6NFB
$\frac{3}{8}$ " NPT PIPE	NFC	15-21AF1NFC	15-21AF2NFC	10-21AF4NFC	10-21AF6NFC
$\frac{1}{2}$ " NPT PIPE	NFD	15-21AF1NFD	15-21AF2NFD	10-21AF4NFD	10-21AF6NFD
$\frac{3}{4}$ " NPT PIPE	NFF	10-21AF1NFF	10-21AF2NFF	10-21AF4NFF	10-21AF6NFF
1" NPT PIPE	NFH	10-21AF1NFH	10-21AF2NFH	10-21AF4NFH	10-21AF6NFH

### Female to Female (continued)

		HF6	HF9	HF16	XF4
		$\frac{3}{8}$ " High Pressure	$\frac{9}{16}$ " High Pressure	1" High Pressure	Ultra $\frac{1}{4}$ " High Pressure
$\frac{1}{16}$ " TAPER SEAL	AF1	15-21AF1HF6	15-21AF1HF9	15-21AF1HF16	15-21AF1XF4
$\frac{1}{8}$ " TAPER SEAL	AF2	15-21AF2HF6	15-21AF2HF9	15-21AF2HF16	15-21AF2XF4
$\frac{1}{4}$ " TAPER SEAL	AF4	10-21AF4HF6	10-21AF4HF9	10-21AF4HF16	10-21AF4XF4
$\frac{3}{8}$ " TAPER SEAL	AF6	10-21AF6HF6	10-21AF6HF9	10-21AF6HF16	10-21AF6XF4
$\frac{1}{4}$ " MEDIUM PRESSURE	LF4	20-21LF4HF6	20-21LF4HF9	20-21LF4HF16	20-21LF4XF4
$\frac{3}{8}$ " MEDIUM PRESSURE	LF6	20-21LF6HF6	20-21LF6HF9	20-21LF6HF16	20-21LF6XF4
$\frac{9}{16}$ " MEDIUM PRESSURE	LF9	20-21LF9HF6	20-21LF9HF9	20-21LF9HF16	20-21LF9XF4
$\frac{3}{4}$ " MEDIUM PRESSURE	LF12	20-21LF12HF6	20-21LF12HF9	20-21LF12HF16	20-21LF12XF4
1" MEDIUM PRESSURE	LF16	20-21LF16HF6	20-21LF16HF9	20-21LF16HF16	20-21LF16XF4
$\frac{1}{8}$ " HIGH PRESSURE	HF2	60-21HF2HF6	60-21HF2HF9	30-21HF2HF16	60-21HF2XF4
$\frac{1}{4}$ " HIGH PRESSURE	HF4	60-21HF4HF6	60-21HF4HF9	30-21HF4HF16	60-21HF4XF4
$\frac{3}{8}$ " HIGH PRESSURE	HF6	60-21HF6	60-21HF6HF9	30-21HF6HF16	60-21HF6XF4
$\frac{9}{16}$ " HIGH PRESSURE	HF9	60-21HF6HF9	60-21HF9	30-21HF9HF16	60-21HF9XF4
1" HIGH PRESSURE	HF16	30-21HF6HF16	30-21HF9HF16	30-21HF16	30-21HF16XF4
$\frac{1}{4}$ " ULTRA HIGH PRESSURE	XF4	60-21HF6XF4	60-21HF9XF4	30-21HF16XF4	100-21XF4
$\frac{3}{8}$ " ULTRA HIGH PRESSURE	XF6	60-21HF6XF6	60-21HF9XF6	30-21HF16XF6	100-21XF4XF6
$\frac{1}{8}$ " NPT PIPE	NFA	30-21HF6NFA	30-21HF9NFA	30-21HF16NFA	30-21XF4NFA
$\frac{1}{4}$ " NPT PIPE	NFB	30-21HF6NFB	30-21HF9NFB	30-21HF16NFB	30-21XF4NFB
$\frac{3}{8}$ " NPT PIPE	NFC	30-21HF6NFC	30-21HF9NFC	30-21HF16NFC	30-21XF4NFC
$\frac{1}{2}$ " NPT PIPE	NFD	30-21HF6NFD	30-21HF9NFD	30-21HF16NFD	30-21XF4NFD
$\frac{3}{4}$ " NPT PIPE	NFF	10-21HF6NFF	10-21HF9NFF	10-21HF16NFF	10-21XF4NFF
1" NPT PIPE	NFH	10-21HF6NFH	10-21HF9NFH	10-21HF16NFH	10-21XF4NFH



## Coupling Selection Guide

LF4	LF6	LF9	LF12	LF16	HF2	HF4
1/4" Medium Pressure	3/8" Medium Pressure	9/16" Medium Pressure	3/4" Medium Pressure	1" Medium Pressure	1/8" High Pressure	1/4" High Pressure
15-21AF1LF4	15-21AF1LF6	15-21AF1LF9	15-21AF1LF12	15-21AF1LF16	15-21AF1HF2	15-21AF1HF4
15-21AF2LF4	15-21AF2LF6	15-21AF2LF9	15-21AF2LF12	15-21AF2LF16	15-21AF2HF2	15-21AF2HF4
10-21AF4LF4	10-21AF4LF6	10-21AF4LF9	10-21AF4LF12	10-21AF4LF16	10-21AF4HF2	10-21AF4HF4
10-21AF6LF4	10-21AF6LF6	10-21AF6LF9	10-21AF6LF12	10-21AF6LF16	10-21AF6HF2	10-21AF6HF4
20-21LF4	20-21LF4LF6	10-21LF4LF9	20-21LF4LF12	20-21LF4LF16	20-21LF4HF2	20-21LF4HF4
20-21LF4LF6	20-21LF6	20-21LF6LF9	20-21LF6LF12	20-21LF6LF16	20-21LF6HF2	20-21LF6HF4
20-21LF4LF9	20-21LF6LF9	20-21LF9	20-21LF9LF12	20-21LF9LF16	20-21LF9HF2	20-21LF9HF4
20-21LF4LF12	20-21LF6LF12	20-21LF9LF12	20-21LF12	20-21LF12LF16	20-21LF12HF2	20-21LF12HF4
20-21LF4LF16	20-21LF6LF16	20-21LF9LF16	20-21LF12LF16	20-21LF16	20-21LF16HF2	20-21LF16HF4
20-21LF4HF2	20-21LF6HF2	20-21LF9HF2	20-21LF12HF2	20-21LF16HF2	60-21HF2	60-21HF2HF4
20-21LF4HF4	20-21LF6HF4	20-21LF9HF4	20-21LF12HF4	20-21LF16HF4	60-21HF2HF4	60-21HF4
20-21LF4HF6	20-21LF6HF6	20-21LF9HF6	20-21LF12HF6	20-21LF16HF6	60-21HF2HF6	60-21HF4HF6
20-21LF4HF9	20-21LF6HF9	20-21LF9HF9	20-21LF12HF9	20-21LF16HF9	60-21HF2HF9	60-21HF4HF9
20-21LF4HF16	20-21LF6HF16	20-21LF9HF16	20-21LF12HF16	20-21LF16HF16	30-21HF2HF16	30-21HF4HF16
20-21LF4XF4	20-21LF6XF4	20-21LF9XF4	20-21LF12XF4	20-21LF16XF4	60-21HF2XF4	60-21HF4XF4
20-21LF4XF6	20-21LF6XF6	20-21LF9XF6	20-21LF12XF6	20-21LF16XF6	60-21HF2XF6	60-21HF4XF6
20-21LF4NFA	20-21LF6NFA	20-21LF9NFA	20-21LF12NFA	20-21LF16NFA	30-21HF2NFA	30-21HF4NFA
20-21LF4NFB	20-21LF6NFB	20-21LF9NFB	20-21LF12NFB	20-21LF16NFB	30-21HF2NFB	30-21HF4NFB
20-21LF4NFC	20-21LF6NFC	20-21LF9NFC	20-21LF12NFC	20-21LF16NFC	30-21HF2NFC	30-21HF4NFC
20-21LF4NFD	20-21LF6NFD	20-21LF9NFD	20-21LF12NFD	20-21LF16NFD	30-21HF2NFD	30-21HF4NFD
10-21LF4NFF	10-21LF6NFF	10-21LF9NFF	10-21LF12NFF	10-21LF16NFF	10-21HF2NFF	10-21HF4NFF
10-21LF4NFH	10-21LF6NFH	10-21LF9NFH	10-21LF12NFH	10-21LF16NFH	10-21HF2NFH	10-21HF4NFH

XF6	NFA	NFB	NFC	NFD	NFF	NFH
3/8" Ultra High Pressure	1/8" NPT Pipe	1/4" NPT Pipe	3/8" NPT Pipe	1/2" NPT Pipe	3/4" NPT Pipe	1" NPT Pipe
15-21AF1XF6	15-21AF1NFA	15-21AF1NFB	15-21AF1NFC	15-21AF1NFD	10-21AF1NFF	10-21AF1NFH
15-21AF2XF6	15-21AF2NFA	15-21AF2NFB	15-21AF2NFC	15-21AF2NFD	10-21AF2NFF	10-21AF2NFH
10-21AF4XF6	10-21AF4NFA	10-21AF4NFB	10-21AF4NFC	10-21AF4NFD	10-21AF4NFF	10-21AF4NFH
10-21AF6XF6	10-21AF6NFA	10-21AF6NFB	10-21AF6NFC	10-21AF6NFD	10-21AF6NFF	10-21AF6NFH
20-21LF4XF6	20-21LF4NFA	20-21LF4NFB	20-21LF4NFC	20-21LF4NFD	10-21LF4NFF	10-21LF4NFH
20-21LF6XF6	20-21LF6NFA	20-21LF6NFB	20-21LF6NFC	20-21LF6NFD	10-21LF6NFF	10-21LF6NFH
20-21LF9XF6	20-21LF9NFA	20-21LF9NFB	20-21LF9NFC	20-21LF9NFD	10-21LF9NFF	10-21LF9NFH
20-21LF12XF6	20-21LF12NFA	20-21LF12NFB	20-21LF12NFC	20-21LF12NFD	10-21LF12NFF	10-21LF12NFH
20-21LF16XF6	20-21LF16NFA	20-21LF16NFB	20-21LF16NFC	20-21LF16NFD	10-21LF16NFF	10-21LF16NFH
60-21HF2XF6	30-21HF2NFA	30-21HF2NFB	30-21HF2NFC	30-21HF2NFD	10-21HF2NFF	10-21HF2NFH
60-21HF4XF6	30-21HF4NFA	30-21HF4NFB	30-21HF4NFC	30-21HF4NFD	10-21HF4NFF	10-21HF4NFH
60-21HF6XF6	30-21HF6NFA	30-21HF6NFB	30-21HF6NFC	30-21HF6NFD	10-21HF6NFF	10-21HF6NFH
60-21HF9XF6	30-21HF9NFA	30-21HF9NFB	30-21HF9NFC	30-21HF9NFD	10-21HF9NFF	10-21HF9NFH
30-21HF16XF6	30-21HF16NFA	30-21HF16NFB	30-21HF16NFC	30-21HF16NFD	10-21HF16NFF	10-21HF16NFH
100-21XF4XF6	30-21XF4NFA	30-21XF4NFB	30-21XF4NFC	30-21XF4NFD	10-21XF4NFF	10-21XF4NFH
150-21XF6	30-21XF6NFA	30-21XF6NFB	30-21XF6NFC	30-21XF6NFD	10-21XF6NFF	10-21XF6NFH
30-21XF6NFA	15-21NFA	15-21NFANFB	15-21NFANFC	15-21NFANFD	10-21NFANFF	10-21NFANFH
30-21XF6NFB	15-21NFB	15-21NFBNFB	15-21NFBNFC	15-21NFBNFD	10-21NFBNFF	10-21NFBNFH
30-21XF6NFC	15-21NFC	15-21NFCNFB	15-21NFC	15-21NFCNFD	10-21NFCNFF	10-21NFCNFH
30-21XF6NFD	15-21NFD	15-21NFDNFB	15-21NFDNFC	15-21NFDNFD	10-21NFDNFF	10-21NFDNFH
10-21XF6NFF	10-21NFF	10-21NFFNFB	10-21NFFNFC	10-21NFFNFD	10-21NFF	10-21NFFNFH
10-21XF6NFH	10-21NFH	10-21NFBNFH	10-21NFCNFH	10-21NFDNFH	10-21NFFNFH	10-21NFH

12

# Accessories

## Adapter Selection Guide

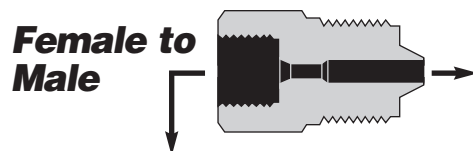

		AM1	AM2	AM4	AM6
		$\frac{1}{16}$ " Taper Seal	$\frac{1}{8}$ " Taper Seal	$\frac{1}{4}$ " Taper Seal	$\frac{3}{8}$ " Taper Seal
$\frac{1}{16}$ " TAPER SEAL	AF1	15-21AF1AM1	15-21AF1AM2	10-21AF1AM4	10-21AF1AM6
$\frac{1}{8}$ " TAPER SEAL	AF2	15-21AF2AM1	15-21AF2AM2	10-21AF2AM4	10-21AF2AM6
$\frac{1}{4}$ " TAPER SEAL	AF4	10-21AF4AM1	10-21AF4AM2	10-21AF4AM4	10-21AF4AM6
$\frac{3}{8}$ " TAPER SEAL	AF6	10-21AF6AM1	10-21AF6AM2	10-21AF6AM4	10-21AF6AM6
$\frac{1}{4}$ " MEDIUM PRESSURE	LF4	15-21LF4AM1	15-21LF4AM2	10-21LF4AM4	10-21LF4AM6
$\frac{3}{8}$ " MEDIUM PRESSURE	LF6	15-21LF6AM1	15-21LF6AM2	10-21LF6AM4	10-21LF6AM6
$\frac{9}{16}$ " MEDIUM PRESSURE	LF9	15-21LF9AM1	15-21LF9AM2	10-21LF9AM4	10-21LF9AM6
$\frac{3}{4}$ " MEDIUM PRESSURE	LF12	15-21LF12AM1	15-21LF12AM2	10-21LF12AM4	10-21LF12AM6
1" MEDIUM PRESSURE	LF16	15-21LF16AM1	15-21LF16AM2	10-21LF16AM4	10-21LF16AM6
$\frac{1}{8}$ " HIGH PRESSURE	HF2	15-21HF2AM1	15-21HF2AM2	10-21HF2AM4	10-21HF2AM6
$\frac{1}{4}$ " HIGH PRESSURE	HF4	15-21HF4AM1	15-21HF4AM2	10-21HF4AM4	10-21HF4AM6
$\frac{3}{8}$ " HIGH PRESSURE	HF6	15-21HF6AM1	15-21HF6AM2	10-21HF6AM4	10-21HF6AM6
$\frac{9}{16}$ " HIGH PRESSURE	HF9	15-21HF9AM1	15-21HF9AM2	10-21HF9AM4	10-21HF9AM6
1" HIGH PRESSURE	HF16	15-21HF16AM1	15-21HF16AM2	10-21HF16AM4	10-21HF16AM6
$\frac{1}{4}$ " ULTRA HIGH PRESSURE	XF4	15-21XF4AM1	15-21XF4AM2	10-21XF4AM4	10-21XF4AM6
$\frac{3}{8}$ " ULTRA HIGH PRESSURE	XF6	15-21XF6AM1	15-21XF6AM2	10-21XF6AM4	10-21XF6AM6
$\frac{1}{8}$ " NPT PIPE	NFA	15-21NFAAM1	15-21NFAAM2	10-21NFAAM4	10-21NFAAM6
$\frac{1}{4}$ " NPT PIPE	NFB	15-21NFBAM1	15-21NFBAM2	10-21NFBAM4	10-21NFBAM6
$\frac{3}{8}$ " NPT PIPE	NFC	15-21NFCAM1	15-21NFCAM2	10-21NFCAM4	10-21NFCAM6
$\frac{1}{2}$ " NPT PIPE	NFD	15-21NFDAM1	15-21NFDAM2	10-21NFDAM4	10-21NFDAM6
$\frac{3}{4}$ " NPT PIPE	NFF	10-21NFFAM1	10-21NFFAM2	10-21NFFAM4	10-21NFFAM6
1" NPT PIPE	NFH	10-21NFHAM1	10-21NFHAM2	10-21NFHAM4	10-21NFHAM6

## Female to Male (continued)

		HM6	HM9	HM16	XM4
		$\frac{3}{8}$ " High Pressure	$\frac{9}{16}$ " High Pressure	1" High Pressure	Ultra $\frac{1}{4}$ " High Pressure
$\frac{1}{16}$ " TAPER SEAL	AF1	15-21AF1HM6	15-21AF1HM9	15-21AF1HM16	15-21AF1XM4
$\frac{1}{8}$ " TAPER SEAL	AF2	15-21AF2HM6	15-21AF2HM9	15-21AF2HM16	15-21AF2XM4
$\frac{1}{4}$ " TAPER SEAL	AF4	10-21AF4HM6	10-21AF4HM9	10-21AF4HM16	10-21AF4XM4
$\frac{3}{8}$ " TAPER SEAL	AF6	10-21AF6HM6	10-21AF6HM9	10-21AF6HM16	10-21AF6XM4
$\frac{1}{4}$ " MEDIUM PRESSURE	LF4	20-21LF4HM6	20-21LF4HM9	20-21LF4HM16	20-21LF4XM4
$\frac{3}{8}$ " MEDIUM PRESSURE	LF6	20-21LF6HM6	20-21LF6HM9	20-21LF6HM16	20-21LF6XM4
$\frac{9}{16}$ " MEDIUM PRESSURE	LF9	20-21LF9HM6	20-21LF9HM9	20-21LF9HM16	20-21LF9XM4
$\frac{3}{4}$ " MEDIUM PRESSURE	LF12	20-21LF12HM6	20-21LF12HM9	20-21LF12HM16	20-21LF12XM4
1" MEDIUM PRESSURE	LF16	20-21LF16HM6	20-21LF16HM9	20-21LF16HM16	20-21LF16XM4
$\frac{1}{8}$ " HIGH PRESSURE	HF2	60-21HF2HM6	60-21HF2HM9	30-21HF2HM16	60-21HF2XM4
$\frac{1}{4}$ " HIGH PRESSURE	HF4	60-21HF4HM6	60-21HF4HM9	30-21HF4HM16	60-21HF4XM4
$\frac{3}{8}$ " HIGH PRESSURE	HF6	60-21HF6HM6	60-21HF6HM9	30-21HF6HM16	60-21HF6XM4
$\frac{9}{16}$ " HIGH PRESSURE	HF9	60-21HF9HM6	60-21HF9HM9	30-21HF9HM16	60-21HF9XM4
1" HIGH PRESSURE	HF16	30-21HF16HM6	30-21HF16HM9	30-21HF16HM16	30-21HF16XM4
$\frac{1}{4}$ " ULTRA HIGH PRESSURE	XF4	60-21XF4HM6	60-21XF4HM9	30-21XF4HM16	100-21XF4XM4
$\frac{3}{8}$ " ULTRA HIGH PRESSURE	XF6	60-21XF6HM6	60-21XF6HM9	30-21XF6HM16	100-21XF6XM4
$\frac{1}{8}$ " NPT PIPE	NFA	30-21NFAHM6	30-21NFAHM9	30-21NFAHM16	30-21NFAXM4
$\frac{1}{4}$ " NPT PIPE	NFB	30-21NFBHM6	30-21NFBHM9	30-21NFBHM16	30-21NFBXM4
$\frac{3}{8}$ " NPT PIPE	NFC	30-21NFCM6	30-21NFCM9	30-21NFCM16	30-21NFCXM4
$\frac{1}{2}$ " NPT PIPE	NFD	30-21NFDHM6	30-21NFDHM9	30-21NFDHM16	30-21NFDXM4
$\frac{3}{4}$ " NPT PIPE	NFF	10-21NFFHM6	10-21NFFHM9	10-21NFFHM16	10-21NFFXM4
1" NPT PIPE	NFH	10-21NFHHM6	10-21NFHHM9	10-21NFHHM16	10-21NFHXM4

## Adapter Selection Guide

LM4	LM6	LM9	LM12	LM16	HM2	HM4
1/4" Medium Pressure	3/8" Medium Pressure	9/16" Medium Pressure	3/4" Medium Pressure	1" Medium Pressure	1/8" High Pressure	1/4" High Pressure
15-21AF1LM4	15-21AF1LM6	15-21AF1LM9	15-21AF1LM12	15-21AF1LM16	15-21AF1HM2	15-21AF1HM4
15-21AF2LM4	15-21AF2LM6	15-21AF2LM9	15-21AF2LM12	15-21AF2LM16	15-21AF2HM2	15-21AF2HM4
10-21AF4LM4	10-21AF4LM6	10-21AF4LM9	10-21AF4LM12	10-21AF4LM16	10-21AF4HM2	10-21AF4HM4
10-21AF6LM4	10-21AF6LM6	10-21AF6LM9	10-21AF6LM12	10-21AF6LM16	10-21AF6HM2	10-21AF6HM4
20-21LF4LM4	20-21LF4LM6	20-21LF4LM9	20-21LF4LM12	20-21LF4LM16	20-21LF4HM2	20-21LF4HM4
20-21LF6LM4	20-21LF6LM6	20-21LF6LM9	20-21LF6LM12	20-21LF6LM16	20-21LF6HM2	20-21LF6HM4
20-21LF9LM4	20-21LF9LM6	20-21LF9LM9	20-21LF9LM12	20-21LF9LM16	20-21LF9HM2	20-21LF9HM4
20-21LF12LM4	20-21LF12LM6	20-21LF12LM9	20-21LF12LM12	20-21LF12LM16	20-21LF12HM2	20-21LF12HM4
20-21LF16LM4	20-21LF16LM6	20-21LF16LM9	20-21LF16LM12	20-21LF16LM16	20-21LF16HM2	20-21LF16HM4
20-21HF2LM4	20-21HF2LM6	20-21HF2LM9	20-21HF2LM12	20-21HF2LM16	60-21HF2HM2	60-21HF2HM4
20-21HF4LM4	20-21HF4LM6	20-21HF4LM9	20-21HF4LM12	20-21HF4LM16	60-21HF4HM2	60-21HF4HM4
20-21HF6LM4	20-21HF6LM6	20-21HF6LM9	20-21HF6LM12	20-21HF6LM16	60-21HF6HM2	60-21HF6HM4
20-21HF9LM4	20-21HF9LM6	20-21HF9LM9	20-21HF9LM12	20-21HF9LM16	60-21HF9HM2	60-21HF9HM4
20-21HF16LM4	20-21HF16LM6	20-21HF16LM9	20-21HF16LM12	20-21HF16LM16	30-21HF16HM2	30-21HF16HM4
20-21XF4LM4	20-21XF4LM6	20-21XF4LM9	20-21XF4LM12	20-21XF4LM16	60-21XF4HM2	60-21XF4HM4
20-21XF6LM4	20-21XF6LM6	20-21XF6LM9	20-21XF6LM12	20-21XF6LM16	60-21XF6HM2	60-21XF6HM4
20-21NFALM4	20-21NFALM6	20-21NFALM9	20-21NFALM12	20-21NFALM16	30-21NFAHM2	30-21NFAHM4
20-21NFBLM4	20-21NFBLM6	20-21NFBLM9	20-21NFBLM12	20-21NFBLM16	30-21NFBHM2	30-21NFBHM4
20-21NFCLM4	20-21NFCLM6	20-21NFCLM9	20-21NFCLM12	20-21NFCLM16	30-21NFCM2	30-21NFCM4
20-21NFDLM4	20-21NFDLM6	20-21NFDLM9	20-21NFDLM12	20-21NFDLM16	30-21NFDHM2	30-21NFDHM4
10-21NFFLM4	10-21NFFLM6	10-21NFFLM9	10-21NFFLM12	10-21NFFLM16	10-21NFFHM2	10-21NFFHM4
10-21NFHLM4	10-21NFHLM6	10-21NFHLM9	10-21NFHLM12	10-21NFHLM16	10-21NFHHM2	10-21NFHHM4

XM6	NMA	NMB	NMC	NMD	NMF	NMH
3/8" Ultra High Pressure	1/8" NPT Pipe	1/4" NPT Pipe	3/8" NPT Pipe	1/2" NPT Pipe	3/4" NPT Pipe	1" NPT Pipe
15-21AF1XM6	15-21AF1NMA	15-21AF1NMB	15-21AF1NMC	15-21AF1NMD	10-21AF1NMF	10-21AF1NMH
15-21AF2XM6	15-21AF2NMA	15-21AF2NMB	15-21AF2NMC	15-21AF2NMD	10-21AF2NMF	10-21AF2NMH
10-21AF4XM6	10-21AF4NMA	10-21AF4NMB	10-21AF4NMC	10-21AF4NMD	10-21AF4NMF	10-21AF4NMH
10-21AF6XM6	10-21AF6NMA	10-21AF6NMB	10-21AF6NMC	10-21AF6NMD	10-21AF6NMF	10-21AF6NMH
20-21LF4XM6	20-21LF4NMA	20-21LF4NMB	20-21LF4NMC	20-21LF4NMD	10-21LF4NMF	10-21LF4NMH
20-21LF6XM6	20-21LF6NMA	20-21LF6NMB	20-21LF6NMC	20-21LF6NMD	10-21LF6NMF	10-21LF6NMH
20-21LF9XM6	20-21LF9NMA	20-21LF9NMB	20-21LF9NMC	20-21LF9NMD	10-21LF9NMF	10-21LF9NMH
20-21LF12XM6	20-21LF12NMA	20-21LF12NMB	20-21LF12NMC	20-21LF12NMD	10-21LF12NMF	10-21LF12NMH
20-21LF16XM6	20-21LF16NMA	20-21LF16NMB	20-21LF16NMC	20-21LF16NMD	10-21LF16NMF	10-21LF16NMH
60-21HF2XM6	30-21HF2NMA	30-21HF2NMB	30-21HF2NMC	30-21HF2NMD	10-21HF2NMF	10-21HF2NMH
60-21HF4XM6	30-21HF4NMA	30-21HF4NMB	30-21HF4NMC	30-21HF4NMD	10-21HF4NMF	10-21HF4NMH
60-21HF6XM6	30-21HF6NMA	30-21HF6NMB	30-21HF6NMC	30-21HF6NMD	10-21HF6NMF	10-21HF6NMH
60-21HF9XM6	30-21HF9NMA	30-21HF9NMB	30-21HF9NMC	30-21HF9NMD	10-21HF9NMF	10-21HF9NMH
30-21HF16XM6	30-21HF16NMA	30-21HF16NMB	30-21HF16NMC	30-21HF16NMD	10-21HF16NMF	10-21HF16NMH
100-21XF4XM6	30-21XF4NMA	30-21XF4NMB	30-21XF4NMC	30-21XF4NMD	10-21XF4NMF	10-21XF4NMH
150-21XF6XM6	30-21XF6NMA	30-21XF6NMB	30-21XF6NMC	30-21XF6NMD	10-21XF6NMF	10-21XF6NMH
30-21NFXM6	15-21NFANMA	15-21NFANMB	15-21NFANMC	15-21NFANMD	10-21NFANMF	10-21NFANMH
30-21NFBXM6	15-21NFBNMA	15-21NFBNMB	15-21NFBNMC	15-21NFBNMD	10-21NFBNMF	10-21NFBNMH
30-21NFCXM6	15-21NFCNMA	15-21NFCNMB	15-21NFCNMC	15-21NFCNMD	10-21NFCNMF	10-21NFCNMH
30-21NFDXM6	15-21NFDNMA	15-21NFDNMB	15-21NFDNMC	15-21NFDNMD	10-21NFDNMF	10-21NFDNMH
10-21NFFXM6	10-21NFFNMA	10-21NFFNMB	10-21NFFNMC	10-21NFFNMD	10-21NFFNMF	10-21NFFNMH
10-21NFHXM6	10-21NFHNMA	10-21NFHNMB	10-21NFHNMC	10-21NFHNMD	10-21NFHNMF	10-21NFHNMH

12

# Accessories

## Adapter Selection Guide

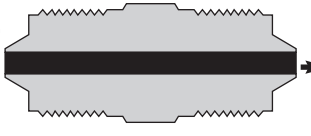

**Male to Male**

		AM1	AM2	AM4	AM6
		1/16" Taper Seal	1/8" Taper Seal	1/4" Taper Seal	3/8" Taper Seal
1/16" TAPER SEAL	AM1	15-21AM1AM1	15-21AM1AM2	10-21AM1AM4	10-21AM1AM6
1/8" TAPER SEAL	AM2	15-21AM1AM2	15-21AM2AM2	10-21AM2AM4	10-21AM2AM6
1/4" TAPER SEAL	AM4	10-21AM1AM4	10-21AM2AM4	10-21AM4AM4	10-21AM4AM6
3/8" TAPER SEAL	AM6	10-21AM1AM6	10-21AM2AM6	10-21AM4AM6	10-21AM6AM6
1/4" MEDIUM PRESSURE	LM4	15-21AM1LM4	15-21AM2LM4	10-21AM4LM4	10-21AM6LM4
3/8" MEDIUM PRESSURE	LM6	15-21AM1LM6	15-21AM2LM6	10-21AM4LM6	10-21AM6LM6
9/16" MEDIUM PRESSURE	LM9	15-21AM1LM9	5-21AM2LM9	10-21AM4LM9	10-21AM6LM9
3/4" MEDIUM PRESSURE	LM12	15-21AM1LM12	15-21AM2LM12	10-21AM4LM12	10-21AM6LM12
1" MEDIUM PRESSURE	LM16	15-21AM1LM16	15-21AM2LM16	10-21AM4LM16	10-21AM6LM16
1/8" HIGH PRESSURE	HM2	15-21AM1HM2	15-21AM2HM2	10-21AM4HM2	10-21AM6HM2
1/4" HIGH PRESSURE	HM4	15-21AM1HM4	15-21AM2HM4	10-21AM4HM4	10-21AM6HM4
3/8" HIGH PRESSURE	HM6	15-21AM1HM6	15-21AM2HM6	10-21AM4HM6	10-21AM6HM6
9/16" HIGH PRESSURE	HM9	15-21AM1HM9	15-21AM2HM9	10-21AM4HM9	10-21AM6HM9
1" HIGH PRESSURE	HM16	15-21AM1HM16	15-21AM2HM16	10-21AM4HM16	10-21AM6HM16
1/4" ULTRA HIGH PRESSURE	XM4	15-21AM1XM4	15-21AM2XM4	10-21AM4XM4	10-21AM6XM4
3/8" ULTRA HIGH PRESSURE	XM6	15-21AM1XM6	15-21AM2XM6	10-21AM4XM6	10-21AM6XM6
1/8" NPT PIPE	NMA	15-21AM1NMA	15-21AM2NMA	10-21AM4NMA	10-21AM6NMA
1/4" NPT PIPE	NMB	15-21AM1NMB	15-21AM2NMB	10-21AM4NMB	10-21AM6NMB
3/8" NPT PIPE	NMC	15-21AM1NMC	15-21AM2NMC	10-21AM4NMC	10-21AM6NMC
1/2" NPT PIPE	NMD	15-21AM1NMD	15-21AM2NMD	10-21AM4NMD	10-21AM6NMD
3/4" NPT PIPE	NMF	10-21AM1NMF	10-21AM2NMF	10-21AM4NMF	10-21AM6NMF
1" NPT PIPE	NMH	10-21AM1NMH	10-21AM2NMH	10-21AM4NMH	10-21AM6NMH

### Male to Male (continued)

		HM6	HM9	HM16	XM4
		3/8" High Pressure	9/16" High Pressure	1" High Pressure	Ultra 1/4" High Pressure
1/16" TAPER SEAL	AM1	15-21AM1HM6	15-21AM1HM9	15-21AM1HM16	15-21AM1XM4
1/8" TAPER SEAL	AM2	15-21AM2HM6	15-21AM2HM9	15-21AM2HM16	15-21AM2XM4
1/4" TAPER SEAL	AM4	10-21AM4HM6	10-21AM4HM9	10-21AM4HM16	10-21AM4XM4
3/8" TAPER SEAL	AM6	10-21AM6HM6	10-21AM6HM9	10-21AM6HM16	10-21AM6XM4
1/4" MEDIUM PRESSURE	LM4	20-21LM4HM6	20-21LM4HM9	20-21LM4HM16	20-21LM4XM4
3/8" MEDIUM PRESSURE	LM6	20-21LM6HM6	20-21LM6HM9	20-21LM6HM16	20-21LM6XM4
9/16" MEDIUM PRESSURE	LM9	20-21LM9HM6	20-21LM9HM9	20-21LM9HM16	20-21LM9XM4
3/4" MEDIUM PRESSURE	LM12	20-21LM12HM6	20-21LM12HM9	20-21LM12HM16	20-21LM12XM4
1" MEDIUM PRESSURE	LM16	20-21LM16HM6	20-21LM16HM9	20-21LM16HM16	20-21LM16XM4
1/8" HIGH PRESSURE	HM2	60-21HM2HM6	60-21HM2HM9	60-21HM2HM16	60-21HM2XM4
1/4" HIGH PRESSURE	HM4	60-21HM4HM6	60-21HM4HM9	60-21HM4HM16	60-21HM4XM4
3/8" HIGH PRESSURE	HM6	60-21HM6HM6	60-21HM6HM9	60-21HM6HM16	60-21HM6XM4
9/16" HIGH PRESSURE	HM9	60-21HM9HM6	60-21HM9HM9	30-21HM9HM16	60-21HM9XM4
1" HIGH PRESSURE	HM16	30-21HM6HM16	30-21HM9HM16	30-21HM16HM16	30-21HM16XM4
1/4" ULTRA HIGH PRESSURE	XM4	60-21HM6XM4	60-21HM9XM4	60-21HM16XM4	100-21XM4XM4
3/8" ULTRA HIGH PRESSURE	XM6	60-21HM6XM6	60-21HM9XM6	60-21HM16XM6	100-21XM4XM6
1/8" NPT PIPE	NMA	30-21HM6NMA	30-21HM9NMA	30-21HM16NMA	30-21XM4NMA
1/4" NPT PIPE	NMB	30-21HM6NMB	30-21HM9NMB	30-21HM16NMB	30-21XM4NMB
3/8" NPT PIPE	NMC	30-21HM6NMC	30-21HM9NMC	30-21HM16NMC	30-21XM4NMC
1/2" NPT PIPE	NMD	30-21HM6NMD	30-21HM9NMD	30-21HM16NMD	30-21XM4NMD
3/4" NPT PIPE	NMF	10-21HM6NMF	10-21HM9NMF	10-21HM16NMF	10-21XM4NMF
1" NPT PIPE	NMH	10-21HM6NMH	10-21HM9NMH	10-21HM16NMH	10-21XM4NMH

## Adapter Selection Guide

LM4	LM6	LM9	LM12	LM16	HM2	HM4
1/4" Medium Pressure	3/8" Medium Pressure	9/16" Medium Pressure	3/4" Medium Pressure	1" Medium Pressure	1/8" High Pressure	1/4" High Pressure
15-21AM1LM4	15-21AM1LM6	15-21AM1LM9	15-21AM1LM12	15-21AM1LM16	15-21AM1HM2	15-21AM1HM4
15-21AM2LM4	15-21AM2LM6	15-21AM2LM9	15-21AM2LM12	15-21AM2LM16	15-21AM2HM2	15-21AM2HM4
10-21AM4LM4	10-21AM4LM6	10-21AM4LM9	10-21AM4LM12	10-21AM4LM16	10-21AM4HM2	10-21AM4HM4
10-21AM6LM4	10-21AM6LM6	10-21AM6LM9	10-21AM6LM12	10-21AM6LM16	10-21AM6HM2	10-21AM6HM4
20-21LM4LM4	20-21LM4LM6	10-21LM4LM9	20-21LM4LM12	20-21LM4LM16	20-21LM4HM2	20-21LM4HM4
20-21LM4LM6	20-21LM6LM6	20-21LM6LM9	20-21LM6LM12	20-21LM6LM16	20-21LM6HM2	20-21LM6HM4
20-21LM4LM9	20-21LM6LM9	20-21LM9LM9	20-21LM9LM12	20-21LM9LM16	20-21LM9HM2	20-21LM9HM4
20-21LM4LM12	20-21LM6LM12	20-21LM9LM12	20-21LM12LM12	20-21LM12LM16	20-21LM12HM2	20-21LM12HM4
20-21LM4LM16	20-21LM6LM16	20-21LM9LM16	20-21LM12LM16	20-21LM16LM16	20-21LM16HM2	20-21LM16HM4
20-21LM4HM2	20-21LM6HM2	20-21LM9HM2	20-21LM12HM2	20-21LM16HM2	60-21HM2HM2	60-21HM2HM4
20-21LM4HM4	20-21LM6HM4	20-21LM9HM4	20-21LM12HM4	20-21LM16HM4	60-21HM2HM4	60-21HM4HM4
20-21LM4HM6	20-21LM6HM6	20-21LM9HM6	20-21LM12HM6	20-21LM16HM6	60-21HM2HM6	60-21HM4HM6
20-21LM4HM9	20-21LM6HM9	20-21LM9HM9	20-21LM12HM9	20-21LM16HM9	60-21HM2HM9	60-21HM4HM9
20-21LM4HM16	20-21LM6HM16	20-21LM9HM16	20-21LM12HM16	20-21LM16HM16	30-21HM2HM16	30-21HM4HM16
20-21LM4XM4	20-21LM6XM4	20-21LM9XM4	20-21LM12XM4	20-21LM16XM4	60-21HM2XM4	60-21HM4XM4
20-21LM4XM6	20-21LM6XM6	20-21LM9XM6	20-21LM12XM6	20-21LM16XM6	60-21HM2XM6	60-21HM4XM6
20-21LM4NMA	20-21LM6NMA	20-21LM9NMA	20-21LM12NMA	20-21LM16NMA	30-21HM2NMA	30-21HM4NMA
20-21LM4NMB	20-21LM6NMB	20-21LM9NMB	20-21LM12NMB	20-21LM16NMB	30-21HM2NMB	30-21HM4NMB
20-21LM4NMC	20-21LM6NMC	20-21LM9NMC	20-21LM12NMC	20-21LM16NMC	30-21HM2NMC	30-21HM4NMC
20-21LM4NMD	20-21LM6NMD	20-21LM9NMD	20-21LM12NMD	20-21LM16NMD	30-21HM2NMD	30-21HM4NMD
10-21LM4NMF	10-21LM6NMF	10-21LM9NMF	10-21LM12NMF	10-21LM16NMF	10-21HM2NMF	10-21HM4NMF
10-21LM4NMH	10-21LM6NMH	10-21LM9NMH	10-21LM12NMH	10-21LM16NMH	10-21HM2NMH	10-21HM4NMH

XM6	NMA	NMB	NMC	NMD	NMF	NMH
3/8" Ultra High Pressure	1/8" NPT Pipe	1/4" NPT Pipe	3/8" NPT Pipe	1/2" NPT Pipe	3/4" NPT Pipe	1" NPT Pipe
15-21AM1XM6	15-21AM1NMA	15-21AM1NMB	15-21AM1NMC	15-21AM1NMD	10-21AM1NMF	10-21AM1NMH
15-21AM2XM6	15-21AM2NMA	15-21AM2NMB	15-21AM2NMC	15-21AM2NMD	10-21AM2NMF	10-21AM2NMH
10-21AM4XM6	10-21AM4NMA	10-21AM4NMB	10-21AM4NMC	10-21AM4NMD	10-21AM4NMF	10-21AM4NMH
10-21AM6XM6	10-21AM6NMA	10-21AM6NMB	10-21AM6NMC	10-21AM6NMD	10-21AM6NMF	10-21AM6NMH
20-21LM4XM6	20-21LM4NMA	20-21LM4NMB	20-21LM4NMC	20-21LM4NMD	10-21LM4NMF	10-21LM4NMH
20-21LM6XM6	20-21LM6NMA	20-21LM6NMB	20-21LM6NMC	20-21LM6NMD	10-21LM6NMF	10-21LM6NMH
20-21LM9XM6	20-21LM9NMA	20-21LM9NMB	20-21LM9NMC	20-21LM9NMD	10-21LM9NMF	10-21LM9NMH
20-21LM12XM6	20-21LM12NMA	20-21LM12NMB	20-21LM12NMC	20-21LM12NMD	10-21LM12NMF	10-21LM12NMH
20-21LM16XM6	20-21LM16NMA	20-21LM16NMB	20-21LM16NMC	20-21LM16NMD	10-21LM16NMF	10-21LM16NMH
60-21HM2XM6	30-21HM2NMA	30-21HM2NMB	30-21HM2NMC	30-21HM2NMD	10-21HM2NMF	10-21HM2NMH
60-21HM4XM6	30-21HM4NMA	30-21HM4NMB	30-21HM4NMC	30-21HM4NMD	10-21HM4NMF	10-21HM4NMH
60-21HM6XM6	30-21HM6NMA	30-21HM6NMB	30-21HM6NMC	30-21HM6NMD	10-21HM6NMF	10-21HM6NMH
60-21HM9XM6	30-21HM9NMA	30-21HM9NMB	30-21HM9NMC	30-21HM9NMD	10-21HM9NMF	10-21HM9NMH
30-21HM16XM6	30-21HM16NMA	30-21HM16NMB	30-21HM16NMC	30-21HM16NMD	10-21HM16NMF	10-21HM16NMH
100-21XM4XM6	30-21XM4NMA	30-21XM4NMB	30-21XM4NMC	30-21XM4NMD	10-21XM4NMF	10-21XM4NMH
150-21XM6XM6	30-21XM6NMA	30-21XM6NMB	30-21XM6NMC	30-21XM6NMD	10-21XM6NMF	10-21XM6NMH
30-21XM6NMA	15-21NMANMA	15-21NMANMA	15-21NMANMC	15-21NMANMD	10-21NMANMF	10-21NMANMH
30-21XM6NMB	15-21NMBNMA	15-21NMBNMA	15-21NMBNMC	15-21NMBNMD	10-21NMBNMF	10-21NMBNMH
30-21XM6NMC	15-21NMCNMA	15-21NMCNMA	15-21NMCNMC	15-21NMCNMD	10-21NMCNMF	10-21NMCNMH
30-21XM6NMD	15-21NMDNMA	15-21NMDNMA	15-21NMDNMC	15-21NMDNMD	10-21NMDNMF	10-21NMDNMH
10-21XM6NMF	10-21NMANMF	10-21NMBNMF	10-21NMCNMF	10-21NMDNMF	10-21NMFNMF	10-21NMFNMH
10-21XM6NMH	10-21NMANMH	10-21NMBNMH	10-21NMCNMH	10-21NMDNMH	10-21NMFNMH	10-21NMHNMH

12

# Accessories

## Adapters: Female to Male

A complete range of adapters is offered for flexibility in going from tube to tube and from tube to pipe.

All standard adapter bodies are made from high tensile 316 stainless steel. Standard tubing glands and collars (sleeves) are provided with adapters unless otherwise specified.

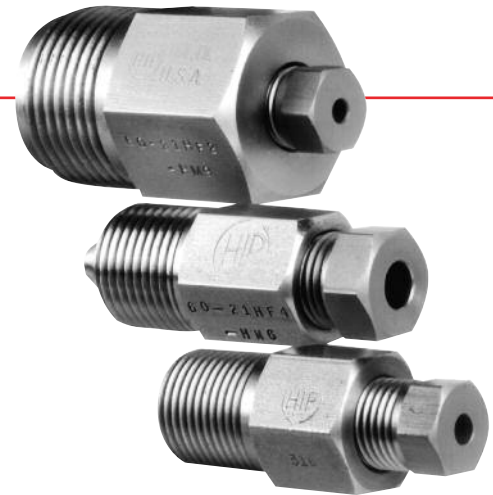

### Female Taper Seal to Male Taper Seal

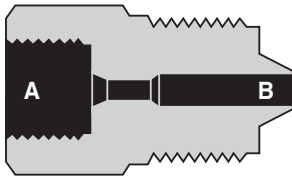

Catalog No.	Pressure Rating psi	Connections	A	B	Length	Hex Size
15-21AF1AM2	15,000	1/16" O.D. TUBE TO 1/8" TAPER SEAL	AF1	AM2	15/16"	5/8"
10-21AF1AM4	10,000	1/16" O.D. TUBE TO 1/4" TAPER SEAL	AF1	AM4	1 1/4"	3/4"
10-21AF1AM6	10,000	1/16" O.D. TUBE TO 3/8" TAPER SEAL	AF1	AM6	1 1/4"	3/4"
10-21AF2AM4	10,000	1/8" O.D. TUBE TO 1/4" TAPER SEAL	AF2	AM4	1 1/4"	3/4"
10-21AF2AM6	10,000	1/8" O.D. TUBE TO 3/8" TAPER SEAL	AF2	AM6	1 1/4"	3/4"

### Female Taper Seal to Male High Pressure

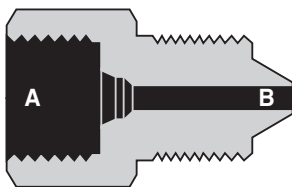

Catalog No.	Pressure Rating psi	Connections	A	B	Length	Hex Size
15-21AF1HM2	15,000	1/16" T.S. TO 1/8" H.P. MALE	AF1	HM2	7/8"	1/2"
15-21AF1HM4	15,000	1/16" T.S. TO 1/4" H.P. MALE	AF1	HM4	1 1/4"	5/8"
15-21AF1HM6	15,000	1/16" T.S. TO 3/8" H.P. MALE	AF1	HM6	1 3/4"	3/4"
15-21AF1HM9	15,000	1/16" T.S. TO 9/16" H.P. MALE	AF1	HM9	2 1/8"	1 1/8"
15-21AF2HM2	15,000	1/8" T.S. TO 1/8" H.P. MALE	AF2	HM2	1 1/8"	5/8"
15-21AF2HM4	15,000	1/8" T.S. TO 1/4" H.P. MALE	AF2	HM4	1 1/4"	5/8"
15-21AF2HM6	15,000	1/8" T.S. TO 3/8" H.P. MALE	AF2	HM6	1 3/4"	3/4"
15-21AF2HM9	15,000	1/8" T.S. TO 9/16" H.P. MALE	AF2	HM9	2 1/8"	1 1/8"
10-21AF4HM2	10,000	1/4" T.S. TO 1/8" H.P. MALE	AF4	HM2	1 7/16"	1"
10-21AF4HM4	10,000	1/4" T.S. TO 1/4" H.P. MALE	AF4	HM4	1 1/2"	1"
10-21AF4HM6	10,000	1/4" T.S. TO 3/8" H.P. MALE	AF4	HM6	1 5/8"	1"
10-21AF4HM9	10,000	1/4" T.S. TO 9/16" H.P. MALE	AF4	HM9	2 1/8"	1 1/8"
10-21AF6HM2	10,000	3/8" T.S. TO 1/8" H.P. MALE	AF6	HM2	1 1/2"	1"
10-21AF6HM4	10,000	3/8" T.S. TO 1/4" H.P. MALE	AF6	HM4	1 1/2"	1"
10-21AF6HM6	10,000	3/8" T.S. TO 3/8" H.P. MALE	AF6	HM6	1 3/4"	1"
10-21AF6HM9	10,000	3/8" T.S. TO 9/16" H.P. MALE	AF6	HM9	2 1/8"	1 1/8"



## Female to Male Adapters

### Female Taper Seal to Male Pipe

Catalog No.	Pressure Rating psi	Connections	A	B	Length	Hex Size
15-21AF1NMA	15,000	1/16" T.S. TO 1/8" NPT MALE	AF1	NMA	1"	1/2"
15-21AF1NMB	15,000	1/16" T.S. TO 1/4" NPT MALE	AF1	NMB	1 1/4"	5/8"
15-21AF1NMC	15,000	1/16" T.S. TO 3/8" NPT MALE	AF1	NMC	1 3/8"	3/4"
15-21AF1NMD	15,000	1/16" T.S. TO 1/2" NPT MALE	AF1	NMD	1 3/4"	1"
10-21AF1NMF	10,000	1/16" T.S. TO 3/4" NPT MALE	AF1	NMF	1 5/8"	1 3/8"
10-21AF1NMH	10,000	1/16" T.S. TO 1" NPT MALE	AF1	NMH	1 5/8"	1 3/8"
15-21AF2NMA	15,000	1/8" T.S. TO 1/8" NPT MALE	AF2	NMA	1 1/4"	3/4"
15-21AF2NMB	15,000	1/8" T.S. TO 1/4" NPT MALE	AF2	NMB	1 1/4"	5/8"
15-21AF2NMC	15,000	1/8" T.S. TO 3/8" NPT MALE	AF2	NMC	1 3/8"	3/4"
15-21AF2NMD	15,000	1/8" T.S. TO 1/2" NPT MALE	AF2	NMD	1 3/4"	1"
10-21AF2NMF	10,000	1/8" T.S. TO 3/4" NPT MALE	AF2	NMF	1 5/8"	1 3/8"
10-21AF2NMH	10,000	1/8" T.S. TO 1" NPT MALE	AF2	NMH	1 5/8"	1 3/8"
10-21AF4NMA	10,000	1/4" T.S. TO 1/8" NPT MALE	AF4	NMA	1 1/2"	1"
10-21AF4NMB	10,000	1/4" T.S. TO 1/4" NPT MALE	AF4	NMB	1 5/8"	1"
10-21AF4NMC	10,000	1/4" T.S. TO 3/8" NPT MALE	AF4	NMC	1 5/8"	1"
10-21AF4NMD	10,000	1/4" T.S. TO 1/2" NPT MALE	AF4	NMD	1 3/4"	1"
10-21AF4NMF	10,000	1/4" T.S. TO 3/4" NPT MALE	AF4	NMF	1 1/2"	1 3/8"
10-21AF4NMH	10,000	1/4" T.S. TO 1" NPT MALE	AF4	NMH	1 7/8"	1 3/8"
10-21AF6NMA	10,000	3/8" T.S. TO 1/8" NPT MALE	AF6	NMA	1 1/2"	1"
10-21AF6NMB	10,000	3/8" T.S. TO 1/4" NPT MALE	AF6	NMB	1 5/8"	1"
10-21AF6NMC	10,000	3/8" T.S. TO 3/8" NPT MALE	AF6	NMC	1 5/8"	1"
10-21AF6NMD	10,000	3/8" T.S. TO 1/2" NPT MALE	AF6	NMD	1 3/4"	1"
10-21AF6NMF	10,000	3/8" T.S. TO 3/4" NPT MALE	AF6	NMF	1 7/8"	1 3/8"
10-21AF6NMH	10,000	3/8" T.S. TO 1" NPT MALE	AF6	NMH	1 7/8"	1 3/8"

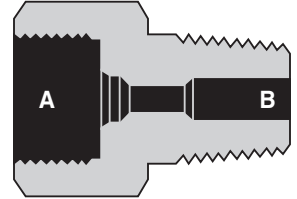

### Female High Pressure to Male High Pressure

Catalog No.	Pressure Rating psi	Connections	A	B	Length	Hex Size
60-21HF2HM4	60,000	1/8" O.D. TUBE TO 1/4" H.P.	HF2	HM4	1 1/4"	5/8"
60-21HF2HM6	60,000	1/8" O.D. TUBE TO 3/8" H.P.	HF2	HM6	1 3/4"	3/4"
60-21HF2HM9	60,000	1/8" O.D. TUBE TO 9/16" H.P.	HF2	HM9	2 1/8"	1 1/8"
60-21HF4HM2	60,000	1/4" O.D. TUBE TO 1/8" H.P.	HF4	HM2	1 3/8"	3/4"
60-21HF4HM6	60,000	1/4" O.D. TUBE TO 3/8" H.P.	HF4	HM6	1 3/4"	3/4"
60-21HF4HM9	60,000	1/4" O.D. TUBE TO 9/16" H.P.	HF4	HM9	2 1/8"	1 1/8"
60-21HF6HM2	60,000	1/4" O.D. TUBE TO 1/8" H.P.	HF6	HM2	1 1/2"	1"
60-21HF6HM4	60,000	3/8" O.D. TUBE TO 1/4" H.P.	HF6	HM4	1 1/2"	1"
60-21HF6HM9	60,000	3/8" O.D. TUBE TO 9/16" H.P.	HF6	HM9	2 1/8"	1 1/8"
60-21HF9HM4	60,000	9/16" O.D. TUBE TO 1/4" H.P.	HF9	HM4	1 3/4"	1 3/8"
60-21HF9HM6	60,000	9/16" O.D. TUBE TO 3/8" H.P.	HF9	HM6	1 7/8"	1 3/8"
60-21HF9HM9	60,000	9/16" O.D. TUBE TO 9/16" H.P.	HF9	HM9	2 1/4"	1 3/8"
30-21HF4HM16	30,000	1/4" H.P. FEMALE TO 1" H.P. MALE	HF4	HM16	3"	1"
30-21HF6HM16	30,000	3/8" H.P. FEMALE TO 1" H.P. MALE	HF6	HM16	3 1/4"	1"
30-21HF9HM16	30,000	9/16" H.P. FEMALE TO 1" H.P. MALE	HF9	HM16	3 5/8"	1 5/8"
20-21HF4LM16	20,000	1/4" H.P. FEMALE TO 1" M.P. MALE	HF4	LM16-30	3"	1"
20-21HF6LM16	20,000	3/8" H.P. FEMALE TO 1" M.P. MALE	HF6	LM16-30	3 1/4"	1"
20-21HF9LM16	20,000	9/16" H.P. FEMALE TO 1" M.P. MALE	HF9	LM16-30	3 5/8"	1 3/8"

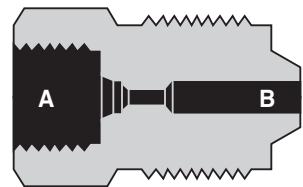

12

# Accessories

## Female to Male Adapters

### Female Medium Pressure to Male Medium Pressure

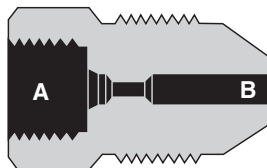

Catalog No.	Pressure Rating psi	Connections	A	B	Length	Hex Size
20-21LF4LM6	20,000	1/4" M.P. FEMALE to 3/8" M.P. MALE	LF4	LM6	1 3/4"	3/4"
20-21LF4LM9	20,000	1/4" M.P. FEMALE to 9/16" M.P. MALE	LF4	LM9	1 7/8"	7/8"
20-21LF6LM4	20,000	3/8" M.P. FEMALE to 1/4" M.P. MALE	LF6	LM4	1 3/4"	3/4"
20-21LF6LM9	20,000	3/8" M.P. FEMALE to 9/16" M.P. MALE	LF6	LM9	1 7/8"	7/8"
20-21LF9LM4	20,000	9/16" M.P. FEMALE to 1/4" M.P. MALE	LF9	LM4	2 1/8"	1"
20-21LF9LM6	20,000	9/16" M.P. FEMALE to 3/8" M.P. MALE	LF9	LM6	2 1/8"	1"
20-21LF12LM4	20,000	3/4" M.P. FEMALE to 1/4" M.P. MALE	LF12	LM4	2 1/4"	1 3/8"
20-21LF12LM6	20,000	3/4" M.P. FEMALE to 3/8" M.P. MALE	LF12	LM6	2 5/8"	1 3/8"
20-21LF12LM9	20,000	3/4" M.P. FEMALE to 9/16" M.P. MALE	LF12	LM9	2 7/8"	1 3/8"
20-21LF12LM16	20,000	3/4" M.P. FEMALE to 1" M.P. MALE	LF12	LM16	3 3/4"	1 3/8"
20-21LF4LM12	20,000	1/4" M.P. FEMALE to 3/4" M.P. MALE	LF4	LM12	2"	1 1/8"
20-21LF6LM12	20,000	3/8" M.P. FEMALE to 3/4" M.P. MALE	LF6	LM12	2"	1 1/8"
20-21LF9LM12	20,000	9/16" M.P. FEMALE to 3/4" M.P. MALE	LF9	LM12	2 1/2"	1 1/8"
20-21LF16LM4	20,000	1" M.P. FEMALE to 1/4" M.P. MALE	LF16-30	LM4	2 3/4"	1 3/4"
20-21LF16LM6	20,000	1" M.P. FEMALE to 3/8" M.P. MALE	LF16-30	LM6	2 7/8"	1 3/4"
20-21LF16LM9	20,000	1" M.P. FEMALE to 9/16" M.P. MALE	LF16-30	LM9	3"	1 3/4"
20-21LF16LM12	20,000	1" M.P. FEMALE to 3/4" M.P. MALE	LF16-30	LM12	3 1/4"	1 3/4"
20-21LF4LM16	20,000	1/4" M.P. FEMALE to 1" M.P. MALE	LF4	LM16	3"	1"
20-21LF6LM16	20,000	3/8" M.P. FEMALE to 1" M.P. MALE	LF6	LM16	3 1/8"	1"
20-21LF9LM16	20,000	9/16" M.P. FEMALE to 1" M.P. MALE	LF9	LM16	3 3/8"	1"

### Female Medium Pressure to Male High Pressure

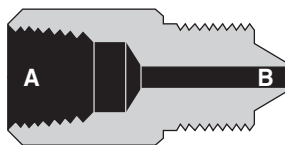

Catalog No.	Pressure Rating psi	Connections	A	B	Length	Hex Size
20-21LF4HM4	20,000	1/4" M.P. FEMALE to 1/4" H.P. MALE	LF4	HM4	1 3/8"	3/4"
20-21LF4HM6	20,000	1/4" M.P. FEMALE to 3/8" H.P. MALE	LF4	HM6	1 3/4"	3/4"
20-21LF4HM9	20,000	1/4" M.P. FEMALE to 9/16" H.P. MALE	LF4	HM9	2 1/8"	1 1/8"
20-21LF6HM4	20,000	3/8" M.P. FEMALE to 1/4" H.P. MALE	LF6	HM4	1 3/4"	3/4"
20-21LF6HM6	20,000	3/8" M.P. FEMALE to 3/8" H.P. MALE	LF6	HM6	1 3/4"	3/4"
20-21LF6HM9	20,000	3/8" M.P. FEMALE to 9/16" H.P. MALE	LF6	HM9	2 1/8"	1 1/8"
20-21LF9HM4	20,000	9/16" M.P. FEMALE to 1/4" H.P. MALE	LF9	HM4	1 7/8"	1"
20-21LF9HM6	20,000	9/16" M.P. FEMALE to 3/8" H.P. MALE	LF9	HM6	2 1/8"	1"
20-21LF9HM9	20,000	9/16" M.P. FEMALE to 9/16" H.P. MALE	LF9	HM9	2 1/8"	1 1/8"
20-21LF12HM4	20,000	3/4" M.P. FEMALE to 1/4" H.P. MALE	LF12	HM4	2 1/2"	1 3/8"
20-21LF12HM6	20,000	3/4" M.P. FEMALE to 3/8" H.P. MALE	LF12	HM6	2 3/8"	1 3/8"
20-21LF12HM9	20,000	3/4" M.P. FEMALE to 9/16" H.P. MALE	LF12	HM9	2 5/8"	1 3/8"
* 20-21LF16HM4	20,000	1" M.P. FEMALE to 1/4" H.P. MALE	LF16	HM4	2 5/8"	1 3/4"
* 20-21LF16HM6	20,000	1" M.P. FEMALE to 3/8" H.P. MALE	LF16	HM6	2 7/8"	1 3/4"
* 20-21LF16HM9	20,000	1" M.P. FEMALE to 9/16" H.P. MALE	LF16	HM9	3 1/8"	1 3/4"

\* Can be rated to 30,000 psi if used with 1" O.D. x 7/16" I.D. tubing.

## Female to Male Adapters

### Female Medium Pressure to Male Pipe

Catalog No.	Pressure Rating psi	Connections	A	B	Length	Hex Size
20-21LF4NMA	15,000	1/4" M.P. FEMALE to 1/8" NPT MALE	LF4	NMA	1 7/16"	3/4"
20-21LF4NMB	15,000	1/4" M.P. FEMALE to 1/4" NPT MALE	LF4	NMB	1 5/8"	3/4"
20-21LF4NMC	15,000	1/4" M.P. FEMALE to 3/8" NPT MALE	LF4	NMC	1 5/8"	3/4"
20-21LF4NMD	15,000	1/4" M.P. FEMALE to 1/2" NPT MALE	LF4	NMD	1 3/4"	1"
10-21LF4NMF	10,000	1/4" M.P. FEMALE to 3/4" NPT MALE	LF4	NMF	1 7/8"	1 3/8"
10-21LF4NMH	10,000	1/4" M.P. FEMALE to 1" NPT MALE	LF4	NMH	1 7/8"	1 3/8"
20-21LF6NMA	15,000	3/8" M.P. FEMALE to 1/8" NPT MALE	LF6	NMA	1 7/16"	3/4"
20-21LF6NMB	15,000	3/8" M.P. FEMALE to 1/4" NPT MALE	LF6	NMB	1 5/8"	3/4"
20-21LF6NMC	15,000	3/8" M.P. FEMALE to 3/8" NPT MALE	LF6	NMC	1 5/8"	3/4"
20-21LF6NMD	15,000	3/8" M.P. FEMALE to 1/2" NPT MALE	LF6	NMD	1 3/4"	1"
10-21LF6NMF	10,000	3/8" M.P. FEMALE to 3/4" NPT MALE	LF6	NMF	1 7/8"	1 3/8"
10-21LF6NMH	10,000	3/8" M.P. FEMALE to 1" NPT MALE	LF6	NMH	1 7/8"	1 3/8"
20-21LF9NMA	15,000	9/16" M.P. FEMALE to 1/8" NPT MALE	LF9	NMA	1 7/8"	1"
20-21LF9NMB	15,000	9/16" M.P. FEMALE to 1/4" NPT MALE	LF9	NMB	1 7/8"	1"
20-21LF9NMC	15,000	9/16" M.P. FEMALE to 3/8" NPT MALE	LF9	NMC	1 7/8"	1"
20-21LF9NMD	15,000	9/16" M.P. FEMALE to 1/2" NPT MALE	LF9	NMD	1 7/8"	1"
10-21LF9NMF	10,000	9/16" M.P. FEMALE to 3/4" NPT MALE	LF9	NMF	1 7/8"	1 3/8"
10-21LF9NMH	10,000	9/16" M.P. FEMALE to 1" NPT MALE	LF9	NMH	1 7/8"	1 3/8"
20-21LF12NMA	15,000	3/4" M.P. FEMALE to 1/8" NPT MALE	LF12	NMA	2 1/2"	1 3/8"
20-21LF12NMB	15,000	3/4" M.P. FEMALE to 1/4" NPT MALE	LF12	NMB	2 1/2"	1 3/8"
20-21LF12NMC	15,000	3/4" M.P. FEMALE to 3/8" NPT MALE	LF12	NMC	2 1/2"	1 3/8"
20-21LF12NMD	15,000	3/4" M.P. FEMALE to 1/2" NPT MALE	LF12	NMD	2 1/2"	1 3/8"
10-21LF12NMF	10,000	3/4" M.P. FEMALE to 3/4" NPT MALE	LF12	NMF	2 1/2"	1 3/8"
10-21LF12NMH	10,000	3/4" M.P. FEMALE to 1" NPT MALE	LF12	NMH	2 1/2"	1 3/8"
20-21LF16NMA	15,000	1" M.P. FEMALE to 1/8" NPT MALE	LF16-30	NMA	2 1/2"	1 3/4"
20-21LF16NMB	15,000	1" M.P. FEMALE to 1/4" NPT MALE	LF16-30	NMB	2 1/2"	1 3/4"
20-21LF16NMC	15,000	1" M.P. FEMALE to 3/8" NPT MALE	LF16-30	NMC	2 1/2"	1 3/4"
20-21LF16NMD	15,000	1" M.P. FEMALE to 1/2" NPT MALE	LF16-30	NMD	2 1/2"	1 3/4"
10-21LF16NMF	10,000	1" M.P. FEMALE to 3/4" NPT MALE	LF16-30	NMF	2 1/2"	1 3/4"
10-21LF16NMH	10,000	1" M.P. FEMALE to 1" NPT MALE	LF16-30	NMH	2 1/2"	1 3/4"

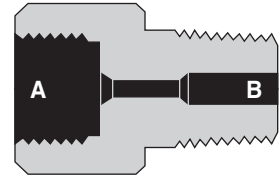

12

# Accessories

## Female to Male Adapters

### Female Pipe to Male High Pressure

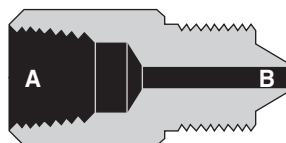

Catalog No.	Pressure Rating psi	Connections	A	B	Length	Hex Size
30-21NFAHM2	15,000	1/8" NPT TO 1/8" H.P. MALE	NFA	HM2	1 5/8"	3/4"
30-21NFBHM2	15,000	1/4" NPT TO 1/8" H.P. MALE	NFB	HM2	1 5/8"	3/4"
30-21NFCM2	15,000	3/8" NPT TO 1/8" H.P. MALE	NFC	HM2	1 3/4"	1"
30-21NFAHM4	15,000	1/8" NPT TO 1/4" H.P. MALE	NFA	HM4	1 5/8"	3/4"
30-21NFBHM4	15,000	1/4" NPT TO 1/4" H.P. MALE	NFB	HM4	1 3/4"	3/4"
30-21NFCM4	15,000	3/8" NPT TO 1/4" H.P. MALE	NFC	HM4	1 3/4"	1"
30-21NFDHM4	15,000	1/2" NPT TO 1/4" H.P. MALE	NFD	HM4	2 1/8"	1 1/8"
30-21NFAHM6	15,000	1/8" NPT TO 3/8" H.P. MALE	NFA	HM6	1 5/8"	3/4"
30-21NFBHM6	15,000	1/4" NPT TO 3/8" H.P. MALE	NFB	HM6	1 3/4"	3/4"
30-21NFCM6	15,000	3/8" NPT TO 3/8" H.P. MALE	NFC	HM6	1 3/4"	1"
30-21NFDHM6	15,000	1/2" NPT TO 3/8" H.P. MALE	NFD	HM6	2 1/8"	1 1/8"
10-21NFFHM6	10,000	3/4" NPT TO 3/8" H.P. MALE	NFF	HM6	2 1/2"	1 5/8"
30-21NFAHM9	15,000	1/8" NPT TO 9/16" H.P. MALE	NFA	HM9	2 1/8"	1 1/8"
30-21NFBHM9	15,000	1/4" NPT TO 9/16" H.P. MALE	NFB	HM9	2 1/8"	1 1/8"
30-21NFCM9	15,000	3/8" NPT TO 9/16" H.P. MALE	NFC	HM9	2 1/8"	1 1/8"
30-21NFDHM9	15,000	1/2" NPT TO 9/16" H.P. MALE	NFD	HM9	2 1/8"	1 1/8"
10-21NFFHM9	10,000	3/4" NPT TO 9/16" H.P. MALE	NFF	HM9	2 1/4"	1 3/8"
10-21NFH9M9	10,000	1" NPT TO 9/16" H.P. MALE	NFH	HM9	2"	1 7/8"

### Female High Pressure to Male Medium Pressure

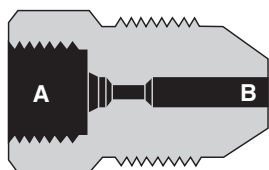

Catalog No.	Pressure Rating psi	Connections	A	B	Length	Hex Size
20-21HF4LM4	20,000	1/4" H.P. FEMALE TO 1/4" M.P. MALE	HF4	LM4	1 3/4"	3/4"
20-21HF4LM6	20,000	1/4" H.P. FEMALE TO 3/8" M.P. MALE	HF4	LM6	1 3/4"	3/4"
20-21HF4LM9	20,000	1/4" H.P. FEMALE TO 9/16" M.P. MALE	HF4	LM9	1 7/8"	7/8"
20-21HF6LM4	20,000	3/8" H.P. FEMALE TO 1/4" M.P. MALE	HF6	LM4	1 7/8"	1"
20-21HF6LM6	20,000	3/8" H.P. FEMALE TO 3/8" M.P. MALE	HF6	LM6	1 7/8"	1"
20-21HF6LM9	20,000	3/8" H.P. FEMALE TO 9/16" M.P. MALE	HF6	LM9	2"	1"
20-21HF9LM4	20,000	9/16" H.P. FEMALE TO 1/4" M.P. MALE	HF9	LM4	2 1/8"	1 3/8"
20-21HF9LM6	20,000	9/16" H.P. FEMALE TO 3/8" M.P. MALE	HF9	LM6	2 1/8"	1 3/8"
20-21HF9LM9	20,000	9/16" H.P. FEMALE TO 9/16" M.P. MALE	HF9	LM9	2 3/8"	1 3/8"
20-21HF4LM12	20,000	1/4" H.P. FEMALE TO 3/4" M.P. MALE	HF4	LM12	2 1/4"	1 1/8"
20-21HF6LM12	20,000	3/8" H.P. FEMALE TO 3/4" M.P. MALE	HF6	LM12	2 1/4"	1 1/8"
20-21HF9LM12	20,000	9/16" H.P. FEMALE TO 3/4" M.P. MALE	HF9	LM12	2 1/2"	1 3/8"
20-21HF4LM16	20,000	1/4" H.P. FEMALE TO 1" M.P. MALE	HF4	LM16	3"	1"
20-21HF6LM16	20,000	3/8" H.P. FEMALE TO 1" M.P. MALE	HF6	LM16	3 1/4"	1"
20-21HF9LM16	20,000	9/16" H.P. FEMALE TO 1" M.P. MALE	HF9	LM16	3 3/8"	1 3/8"

## Female to Male Adapters

### Female High Pressure to Male Pipe

Catalog No.	Pressure Rating psi	Connections	A	B	Length	Hex Size
30-21HF2NMA	15,000	1/8" H.P. TO 1/8" NPT MALE	HF2	NMA	1 1/4"	5/8"
30-21HF2NMB	15,000	1/8" H.P. TO 1/4" NPT MALE	HF2	NMB	1 1/4"	5/8"
30-21HF2NMC	15,000	1/8" H.P. TO 3/8" NPT MALE	HF2	NMC	1 3/8"	3/4"
30-21HF2NMD	15,000	1/8" H.P. TO 1/2" NPT MALE	HF2	NMD	1 1/2"	1"
10-21HF2NMF	10,000	1/8" H.P. TO 3/4" NPT MALE	HF2	NMF	1 3/4"	1 3/8"
10-21HF2NMH	10,000	1/8" H.P. TO 1" NPT MALE	HF2	NMH	1 3/4"	1 3/8"
30-21HF4NMA	15,000	1/4" H.P. TO 1/8" NPT MALE	HF4	NMA	1 1/4"	3/4"
30-21HF4NMB	15,000	1/4" H.P. TO 1/4" NPT MALE	HF4	NMB	1 3/8"	3/4"
30-21HF4NMC	15,000	1/4" H.P. TO 3/8" NPT MALE	HF4	NMC	1 3/8"	3/4"
30-21HF4NMD	15,000	1/4" H.P. TO 1/2" NPT MALE	HF4	NMD	1 3/4"	1"
10-21HF4NMF	10,000	1/4" H.P. TO 3/4" NPT MALE	HF4	NMF	1 3/4"	1 3/8"
10-21HF4NMH	10,000	1/4" H.P. TO 1" NPT MALE	HF4	NMH	1 5/8"	1 3/8"
30-21HF6NMA	15,000	3/8" H.P. TO 1/8" NPT MALE	HF6	NMA	1 1/2"	1"
30-21HF6NMB	15,000	3/8" H.P. TO 1/4" NPT MALE	HF6	NMB	1 5/8"	1"
30-21HF6NMC	15,000	3/8" H.P. TO 3/8" NPT MALE	HF6	NMC	1 5/8"	1"
30-21HF6NMD	15,000	3/8" H.P. TO 1/2" NPT MALE	HF6	NMD	1 3/4"	1"
10-21HF6NMF	10,000	3/8" H.P. TO 3/4" NPT MALE	HF6	NMF	1 7/8"	1 3/8"
10-21HF6NMH	10,000	3/8" H.P. TO 1" NPT MALE	HF6	NMH	1 7/8"	1 3/8"
30-21HF9NMA	15,000	9/16" H.P. TO 1/8" NPT MALE	HF9	NMA	1 1/2"	1 3/8"
30-21HF9NMB	15,000	9/16" H.P. TO 1/4" NPT MALE	HF9	NMB	1 5/8"	1 3/8"
30-21HF9NMC	15,000	9/16" H.P. TO 3/8" NPT MALE	HF9	NMC	1 3/4"	1 3/8"
30-21HF9NMD	15,000	9/16" H.P. TO 1/2" NPT MALE	HF9	NMD	1 7/8"	1 3/8"
10-21HF9NMF	10,000	9/16" H.P. TO 3/4" NPT MALE	HF9	NMF	1 7/8"	1 3/8"
10-21HF9NMH	10,000	9/16" H.P. TO 1" NPT MALE	HF9	NMH	2"	1 3/8"

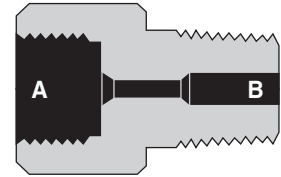

### Female Pipe to Male Taper Seal

Catalog No.	Pressure Rating psi	Connections	A	B	Hex Length	Size
15-21NFAAM2	15,000	1/8" FNPT TO 1/8" MALE T.S.	NFA	AM2	1 1/2"	5/8"
15-21NFBAM2	15,000	1/4" FNPT TO 1/8" MALE T.S.	NFB	AM2	1 5/8"	3/4"
15-21NFCAM2	15,000	3/8" FNPT TO 1/8" MALE T.S.	NFC	AM2	1 3/4"	1"
10-21NFAAM4	10,000	1/8" FNPT TO 1/4" MALE T.S.	NFA	AM4	1 3/4"	7/8"
10-21NFBAM4	10,000	1/4" FNPT TO 1/4" MALE T.S.	NFB	AM4	1 3/4"	1"
10-21NFCAM4	10,000	3/8" FNPT TO 1/4" MALE T.S.	NFC	AM4	1 3/4"	1"
10-21NFDAM4	10,000	1/2" FNPT TO 1/4" MALE T.S.	NFD	AM4	2 1/8"	1 1/8"
10-21NFAAM6	10,000	1/8" FNPT TO 3/8" MALE T.S.	NFA	AM6	2"	1"
10-21NFBAM6	10,000	1/4" FNPT TO 3/8" MALE T.S.	NFB	AM6	2"	1"
10-21NFCAM6	10,000	3/8" FNPT TO 3/8" MALE T.S.	NFC	AM6	2"	1"
10-21NFDAM6	10,000	1/2" FNPT TO 3/8" MALE T.S.	NFD	AM6	2 1/8"	1 1/8"

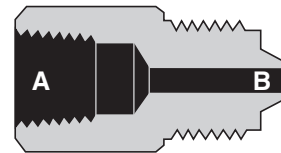

12

# Accessories

## Female to Male Adapters

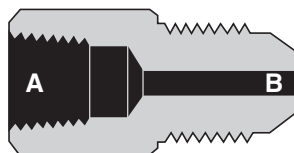

### Female Pipe to Male Medium Pressure

Catalog No.	Pressure Rating psi	Connections	A	B	Length	Hex Size
20-21NFALM4	15,000	1/8" N.P.T. FEMALE to 1/4" M.P. MALE	NFA	LM4	1 3/4"	3/4"
20-21NFBLM4	15,000	1/4" N.P.T. FEMALE to 1/4" M.P. MALE	NFB	LM4	1 3/4"	3/4"
20-21NFCLM4	15,000	3/8" N.P.T. FEMALE to 1/4" M.P. MALE	NFC	LM4	2"	1"
20-21NFDM4	15,000	1/2" N.P.T. FEMALE to 1/4" M.P. MALE	NFD	LM4	2 1/8"	1 1/8"
10-21NFFLM4	10,000	3/4" N.P.T. FEMALE to 1/4" M.P. MALE	NFF	LM4	2 3/8"	1 3/8"
20-21NFALM6	15,000	1/8" N.P.T. FEMALE to 3/8" M.P. MALE	NFA	LM6	1 7/8"	3/4"
20-21NFBLM6	15,000	1/4" N.P.T. FEMALE to 3/8" M.P. MALE	NFB	LM6	1 7/8"	3/4"
20-21NFCLM6	15,000	3/8" N.P.T. FEMALE to 3/8" M.P. MALE	NFC	LM6	2 1/8"	1"
20-21NFDM6	15,000	1/2" N.P.T. FEMALE to 3/8" M.P. MALE	NFD	LM6	2 1/4"	1 1/8"
10-21NFFLM6	10,000	3/4" N.P.T. FEMALE to 3/8" M.P. MALE	NFF	LM6	2 1/2"	1 3/8"
10-21NFHLM6	10,000	1" N.P.T. FEMALE to 3/8" M.P. MALE	NFH	LM6	2 7/8"	1 7/8"
20-21NFALM9	15,000	1/8" N.P.T. FEMALE to 9/16" M.P. MALE	NFA	LM9	1 7/8"	7/8"
20-21NFBLM9	15,000	1/4" N.P.T. FEMALE to 9/16" M.P. MALE	NFB	LM9	1 7/8"	7/8"
20-21NFCLM9	15,000	3/8" N.P.T. FEMALE to 9/16" M.P. MALE	NFC	LM9	2 1/4"	1"
20-21NFDM9	15,000	1/2" N.P.T. FEMALE to 9/16" M.P. MALE	NFD	LM9	2 5/8"	1 1/8"
10-21NFFLM9	10,000	3/4" N.P.T. FEMALE to 9/16" M.P. MALE	NFF	LM9	2 5/8"	1 3/8"
10-21NFHLM9	10,000	1" N.P.T. FEMALE to 9/16" M.P. MALE	NFH	LM9	3"	1 7/8"
20-21NFALM12	15,000	1/8" N.P.T. FEMALE to 3/4" M.P. MALE	NFA	LM12	2"	1 1/8"
20-21NFBLM12	15,000	1/4" N.P.T. FEMALE to 3/4" M.P. MALE	NFB	LM12	2"	1 1/8"
20-21NFCLM12	15,000	3/8" N.P.T. FEMALE to 3/4" M.P. MALE	NFC	LM12	2"	1 1/8"
20-21NFDM12	15,000	1/2" N.P.T. FEMALE to 3/4" M.P. MALE	NFD	LM12	2 1/2"	1 1/8"
10-21NFFLM12	10,000	3/4" N.P.T. FEMALE to 3/4" M.P. MALE	NFF	LM12	2 3/4"	1 1/2"
10-21NFHLM12	10,000	1" N.P.T. FEMALE to 3/4" M.P. MALE	NFH	LM12	3"	1 7/8"
20-21NFALM16	15,000	1/8" N.P.T. FEMALE to 1" M.P. MALE	NFA	LM16	3"	1"
20-21NFBLM16	15,000	1/4" N.P.T. FEMALE to 1" M.P. MALE	NFB	LM16	3"	1"
20-21NFCLM16	15,000	3/8" N.P.T. FEMALE to 1" M.P. MALE	NFC	LM16	3"	1"
20-21NFDM16	15,000	1/2" N.P.T. FEMALE to 1" M.P. MALE	NFD	LM16	3 3/4"	1 1/8"
10-21NFFLM16	10,000	3/4" N.P.T. FEMALE to 1" M.P. MALE	NFF	LM16	4 1/8"	1 1/2"
10-21NFHLM16	10,000	1" N.P.T. FEMALE to 1" M.P. MALE	NFH	LM16	4 3/8"	1 7/8"



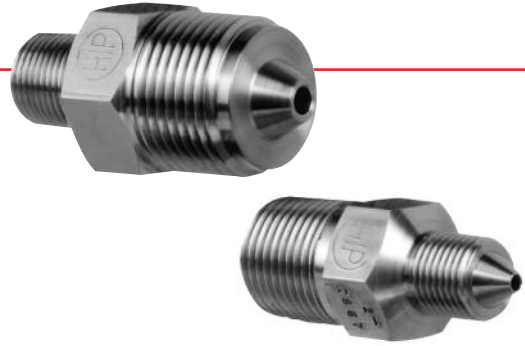

## Adapters: Male to Male

Male to Male Adapters are available in the most commonly used sizes as listed below. These adapters permit the user to convert female connections to male connections, and are especially useful in confined installations or where rigidity is required. **Standard material** is high tensile Type 316 stainless steel.

### Male Taper Seal to Male Taper Seal

Catalog No.	Pressure Rating psi	Connections	A	B	Length	Hex Size
15-21AM1AM1	15,000	1/16" T.S. to 1/16" T.S.	AM1	AM1	1 3/8"	1/2"
15-21AM2AM2	15,000	1/8" T.S. to 1/8" T.S.	AM2	AM2	1 5/8"	5/8"
10-21AM2AM4	10,000	1/8" T.S. to 1/4" T.S.	AM2	AM4	1 7/8"	7/8"
10-21AM4AM4	10,000	1/4" T.S. to 1/4" T.S.	AM4	AM4	2 1/8"	7/8"
10-21AM4AM6	10,000	1/4" T.S. to 3/8" T.S.	AM4	AM6	2 1/8"	3/4"
10-21AM6AM6	10,000	3/8" T.S. to 3/8" T.S.	AM6	AM6	2 1/8"	3/4"

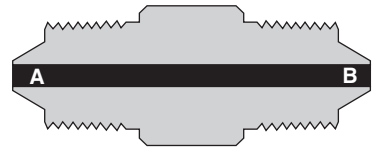

### Male Taper Seal to Male Medium Pressure

Catalog No.	Pressure Rating psi	Connections	A	B	Length	Hex Size
10-21AM4LM4	10,000	1/4" T.S. to 1/4" M.P.	AM4	LM4	2 1/8"	7/8"
10-21AM4LM6	10,000	1/4" T.S. to 3/8" M.P.	AM4	LM6	2 3/16"	7/8"
10-21AM4LM9	10,000	1/4" T.S. to 9/16" M.P.	AM4	LM9	2 7/8"	7/8"
10-21AM6LM4	10,000	3/8" T.S. to 1/4" M.P.	AM6	LM4	2 1/8"	7/8"
10-21AM6LM6	10,000	3/8" T.S. to 3/8" M.P.	AM6	LM6	2 3/16"	7/8"
10-21AM6LM9	10,000	3/8" T.S. to 9/16" M.P.	AM6	LM9	2 7/8"	7/8"
15-21AM2LM4	15,000	1/8" T.S. to 1/4" M.P.	AM2	LM4	1 7/8"	1/2"
15-21AM2LM6	15,000	1/8" T.S. to 3/8" M.P.	AM2	LM6	2"	5/8"
15-21AM2LM9	15,000	1/8" T.S. to 9/16" M.P.	AM2	LM9	2 1/8"	7/8"

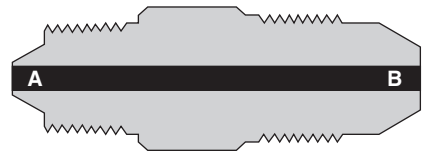

### Male Taper Seal to Male Pipe

Catalog No.	Pressure Rating psi	Connections	A	B	Length	Hex Size
15-21AM1NMA	15,000	1/16" T.S. to 1/8" NPT MALE	AM1	NMA	1 7/16"	1/2"
15-21AM1NMB	15,000	1/16" T.S. to 1/4" NPT MALE	AM1	NMB	1 9/16"	5/8"
15-21AM2NMA	15,000	1/8" T.S. to 1/8" NPT MALE	AM2	NMA	1 5/8"	1/2"
15-21AM2NMB	15,000	1/8" T.S. to 1/4" NPT MALE	AM2	NMB	1 3/4"	5/8"
10-21AM4NMB	10,000	1/4" T.S. to 1/4" NPT MALE	AM4	NMB	2"	3/4"

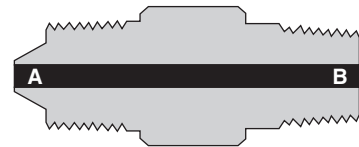

# Accessories

## Male to Male Adapters

### Male Taper Seal to Male High Pressure



Catalog No.	Pressure Rating psi	Connections	A	B	Length	Hex Size
15-21AM2HM2	15,000	1/8" T.S. to 1/8" H.P.	AM2	HM2	1 9/16"	5/8"
15-21AM2HM4	15,000	1/8" T.S. to 1/4" H.P.	AM2	HM4	1 5/8"	3/4"
10-21AM4HM4	10,000	1/4" T.S. to 1/4" H.P.	AM4	HM4	2"	3/4"

### Male Medium Pressure to Male High Pressure



Catalog No.	Pressure Rating psi	Connections	A	B	Length	Hex Size
20-21LM4HM2	20,000	1/4" M.P. to 1/8" H.P.	LM4	HM2	1 7/8"	5/8"
20-21LM4HM4	20,000	1/4" M.P. to 1/4" H.P.	LM4	HM4	2"	5/8"
20-21LM4HM6	20,000	1/4" M.P. to 3/8" H.P.	LM4	HM6	2 1/8"	1"
20-21LM4HM9	20,000	1/4" M.P. to 9/16" H.P.	LM4	HM9	2 3/8"	1 1/8"
20-21LM4HM16	20,000	1/4" M.P. to 1" H.P.	LM4	HM16	3 5/8"	1"
20-21LM6HM2	20,000	3/8" M.P. to 1/8" H.P.	LM6	HM2	1 7/8"	5/8"
20-21LM6HM4	20,000	3/8" M.P. to 1/4" H.P.	LM6	HM4	2 1/8"	5/8"
20-21LM6HM6	20,000	3/8" M.P. to 3/8" H.P.	LM6	HM6	2 1/4"	7/8"
20-21LM6HM9	20,000	3/8" M.P. to 9/16" H.P.	LM6	HM9	2 1/2"	2 1/2"
20-21LM6HM16	20,000	3/8" M.P. to 1" H.P.	LM6	HM16	3 3/4"	1"
20-21LM9HM2	20,000	9/16" M.P. to 1/8" H.P.	LM9	HM2	2 1/4"	7/8"
20-21LM9HM4	20,000	9/16" M.P. to 1/4" H.P.	LM9	HM4	2 1/4"	2 1/4"
20-21LM9HM6	20,000	9/16" M.P. to 3/8" H.P.	LM9	HM6	2 1/2"	7/8"
20-21LM9HM9	20,000	9/16" M.P. to 9/16" H.P.	LM9	HM9	2 5/8"	2 5/8"
20-21LM9HM16	20,000	9/16" M.P. to 1" H.P.	LM9	HM16	4 1/16"	1"
20-21LM12HM4	20,000	3/4" M.P. to 1/4" H.P.	LM12	HM4	2 1/2"	1 1/8"
20-21LM12HM6	20,000	3/4" M.P. to 3/8" H.P.	LM12	HM6	2 7/8"	1 1/8"
20-21LM12HM9	20,000	3/4" M.P. to 9/16" H.P.	LM12	HM9	3"	1 1/8"
20-21LM12HM16	20,000	3/4" M.P. to 1" H.P.	LM12	HM16	4 3/8"	1 1/8"
20-21LM16HM4	20,000	1" M.P. to 1/4" H.P.	LM16	HM4	3 5/8"	1"
20-21LM16HM6	20,000	1" M.P. to 3/8" H.P.	LM16	HM6	4"	1 1/8"
20-21LM16HM9	20,000	1" M.P. to 9/16" H.P.	LM16	HM96	4"	1 1/8"

## Male to Male Adapters

### Male Medium Pressure to Male Pipe (NPT)

Catalog No.	Pressure Rating psi	Connections	A	B	Length	Hex Size
20-21LM4NMB	15,000	1/4" M.P. to 1/4" NPT MALE	LM4	NMB	2"	5/8"
20-21LM4NMD	15,000	1/4" M.P. to 1/2" NPT MALE	LM4	NMD	2 1/8"	7/8"
20-21LM6NMB	15,000	3/8" M.P. to 1/4" NPT MALE	LM6	NMB	2 1/16"	3/4"
20-21LM6NMC	15,000	3/8" M.P. to 3/8" NPT MALE	LM6	NMC	2 1/16"	3/4"
20-21LM6NMD	15,000	3/8" M.P. to 1/2" NPT MALE	LM6	NMD	2 3/16"	7/8"
20-21LM9NMA	15,000	9/16" M.P. to 1/8" NPT MALE	LM9	NMA	2 1/8"	7/8"
20-21LM9NMB	15,000	9/16" M.P. to 1/4" NPT MALE	LM9	NMB	2 1/4"	7/8"
20-21LM9NMC	15,000	9/16" M.P. to 3/8" NPT MALE	LM9	NMC	2 1/4"	7/8"
20-21LM9NMD	15,000	9/16" M.P. to 1/2" NPT MALE	LM9	NMD	2 3/8"	7/8"
10-21LM9NMF	10,000	9/16" M.P. to 3/4" NPT MALE	LM9	NMF	2 5/8"	1 1/8"
10-21LM9NMH	10,000	9/16" M.P. to 1" NPT MALE	LM9	NMH	2 5/8"	1 3/8"
20-21LM12NMA	15,000	3/4" M.P. to 1/8" NPT MALE	LM12	NMA	2 3/8"	1 1/8"
20-21LM12NMB	15,000	3/4" M.P. to 1/4" NPT MALE	LM12	NMB	2 1/2"	1 1/8"
20-21LM12NMC	15,000	3/4" M.P. to 3/8" NPT MALE	LM12	NMC	2 1/2"	1 1/8"
20-21LM12NMD	15,000	3/4" M.P. to 1/2" NPT MALE	LM12	NMD	2 5/8"	1 1/8"
10-21LM12NMF	10,000	3/4" M.P. to 3/4" NPT MALE	LM12	NMF	2 3/4"	1 1/8"
10-21LM12NMH	10,000	3/4" M.P. to 1" NPT MALE	LM12	NMH	3"	1 3/8"
20-21LM16NMA	15,000	1" M.P. to 1/8" NPT MALE	LM16	NMA	3 5/8"	1"
20-21LM16NMB	15,000	1" M.P. to 1/4" NPT MALE	LM16	NMB	3 3/4"	1"
20-21LM16NMC	15,000	1" M.P. to 3/8" NPT MALE	LM16	NMC	3 3/4"	1"
20-21LM16NMD	15,000	1" M.P. to 1/2" NPT MALE	LM16	NMD	3 7/8"	1"
10-21LM16NMF	10,000	1" M.P. to 3/4" NPT MALE	LM16	NMF	3 7/8"	1 1/8"
10-21LM16NMH	10,000	1" M.P. to 1" NPT MALE	LM16	NMH	4"	1 3/8"

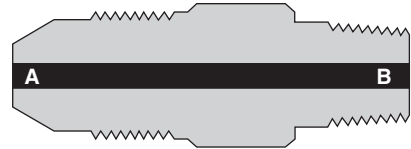

### Male Medium Pressure to Male Medium Pressure

Catalog No.	Pressure Rating psi	Connections	A	B	Length	Hex Size
20-21LM4LM4	20,000	1/4" M.P. to 1/4" M.P.	LM4	LM4	2"	5/8"
20-21LM4LM6	20,000	1/4" M.P. to 3/8" M.P.	LM4	LM4	2 1/8"	3/4"
20-21LM6LM6	20,000	3/8" M.P. to 3/8" M.P.	LM6	LM6	2 1/4"	3/4"
20-21LM6LM9	20,000	3/8" M.P. to 9/16" M.P.	LM6	LM9	2 1/2"	7/8"
20-21LM9LM9	20,000	9/16" M.P. to 9/16" M.P.	LM9	LM9	2 5/8"	7/8"
20-21LM4LM12	20,000	1/4" M.P. to 3/4" M.P.	LM4	LM12	2 1/2"	1 1/8"
20-21LM6LM12	20,000	3/8" M.P. to 3/4" M.P.	LM6	LM12	2 5/8"	1 1/8"
20-21LM9LM12	20,000	9/16" M.P. to 3/4" M.P.	LM9	LM12	2 7/8"	1 1/8"
20-21LM4LM16	20,000	1/4" M.P. to 1" M.P.	LM4	LM16	3 5/8"	1"
20-21LM6LM16	20,000	3/8" M.P. to 1" M.P.	LM6	LM16	3 3/4"	1"
20-21LM9LM16	20,000	9/16" M.P. to 1" M.P.	LM9	LM16	4"	1"
20-21LM12LM12	20,000	3/4" M.P. to 3/4" M.P.	LM12	LM12	3"	1 1/8"
20-21LM12LM16	20,000	3/4" M.P. to 1" M.P.	LM12	LM16	3 1/8"	1 1/8"



**12**

# Accessories

## Male to Male Adapters

### Male High Pressure to Male Pipe (NPT)

Catalog No.	Pressure Rating psi	Connections	A	B	Length	Hex Size
30-21HM2NMA	15,000	1/8" H.P. to 1/8" NPT MALE	HM2	NMA	1 5/8"	1/2"
30-21HM2NMB	15,000	1/8" H.P. to 1/4" NPT MALE	HM2	NMB	1 3/4"	5/8"
30-21HM4NMA	15,000	1/4" H.P. to 1/8" NPT MALE	HM4	NMA	1 7/8"	5/8"
30-21HM4NMB	15,000	1/4" H.P. to 1/4" NPT MALE	HM4	NMB	2"	5/8"
30-21HM4NMC	15,000	1/4" H.P. to 3/8" NPT MALE	HM4	NMC	2"	3/4"
30-21HM4NMD	15,000	1/4" H.P. to 1/2" NPT MALE	HM4	NMD	2 1/8"	7/8"
10-21HM4NMF	10,000	1/4" H.P. to 3/4" NPT MALE	HM4	NMF	2 1/4"	1 1/8"
30-21HM6NMB	15,000	3/8" H.P. to 1/4" NPT MALE	HM6	NMB	2 1/8"	7/8"
30-21HM6NMC	15,000	3/8" H.P. to 3/8" NPT MALE	HM6	NMC	2 1/8"	7/8"
30-21HM9NMB	15,000	9/16" H.P. to 1/4" NPT MALE	HM9	NMB	2 3/8"	1 1/8"
30-21HM9NMC	15,000	9/16" H.P. to 3/8" NPT MALE	HM9	NMC	2 3/8"	1 1/8"
30-21HM9NMD	15,000	9/16" H.P. to 1/2" NPT MALE	HM9	NMD	2 1/2"	1 1/8"
10-21HM9NMF	10,000	9/16" H.P. to 3/4" NPT MALE	HM9	NMF	2 5/8"	1 1/8"
10-21HM9NMH	10,000	9/16" H.P. to 1" NPT MALE	HM9	NMH	2 3/4"	1 3/8"



### Male High Pressure to Male High Pressure

Catalog No.	Pressure Rating psi	Connections	A	B	Length	Hex Size
60-21HM2HM2	60,000	1/8" H.P. to 1/8" H.P.	HM2	HM2	1 1/2"	1/2"
60-21HM2HM4	60,000	1/8" H.P. to 1/4" H.P.	HM2	HM4	1 5/8"	5/8"
60-21HM4HM4	60,000	1/4" H.P. to 1/4" H.P.	HM4	HM4	1 11/16"	5/8"
60-21HM4HM6	60,000	1/4" H.P. to 3/8" H.P.	HM4	HM6	2 1/16"	3/4"
60-21HM4HM9	60,000	1/4" H.P. to 9/16" H.P.	HM4	HM9	2 1/4"	1 1/8"
60-21HM6HM6	60,000	3/8" H.P. to 3/8" H.P.	HM6	HM6	2 1/4"	3/4"
60-21HM6HM9	60,000	3/8" H.P. to 9/16" H.P.	HM6	HM9	2 1/2"	1 1/8"
60-21HM9HM9	60,000	9/16" H.P. to 9/16" H.P.	HM9	HM9	2 5/8"	1 1/8"
30-21HM4HM16	30,000	1" H.P. to 1" M.P.	HM4	HM16	3 5/8"	1"
30-21HM6HM16	30,000	1" H.P. to 1" M.P.	HM6	HM16	4"	1"
30-21HM9HM16	30,000	1" H.P. to 1" M.P.	HM9	HM16	4"	1 1/8"



12

## NPT Fittings

A complete line of couplings and adapters with NPT threaded connections are now available. These fittings feature 316 cold-worked stainless steel construction, with other materials available. HiP maintains an inventory of these fittings for quick ship requirements.

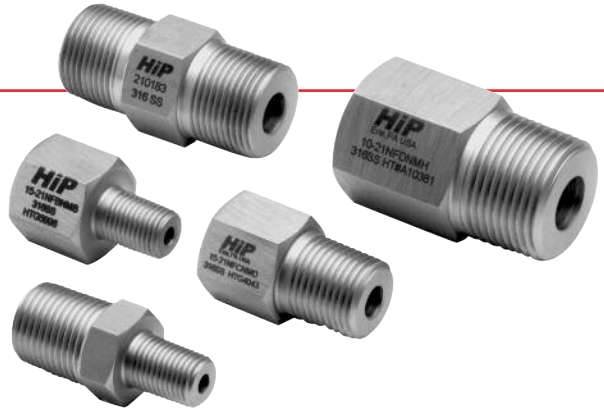

## NPT Straight Couplings

Catalog No.	Pressure Rating psi	Connections	A	B	Length	Hex Size
15-21NFA	15,000	1/8" FEMALE NPT x 1/8" FEMALE NPT	NFA	NFA	1 1/4"	3/4"
15-21NFB	15,000	1/4" FEMALE NPT x 1/4" FEMALE NPT	NFB	NFB	1 3/4"	1"
15-21NFC	15,000	3/8" FEMALE NPT x 3/8" FEMALE NPT	NFC	NFC	1 3/8"	1"
15-21NFD	15,000	1/2" FEMALE NPT x 1/2" FEMALE NPT	NFD	NFD	1 7/8"	1 3/8"
10-21NFF	10,000	3/4" FEMALE NPT x 3/4" FEMALE NPT	NFF	NFF	2 1/2"	1 3/8"
10-21NFH	10,000	1" FEMALE NPT x 1" FEMALE NPT	NFH	NFH	2 1/2"	1 3/4"

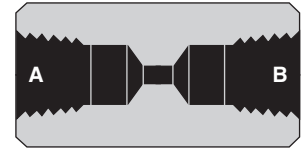

## NPT Reducer Couplings

Catalog No.	Pressure Rating psi	Connections	A	B	Length	Hex Size
15-21NFBNFC	15,000	1/4" FEMALE NPT x 3/8" FEMALE NPT	NFB	NFC	1 1/2"	1"
15-21NFBNFD	15,000	1/4" FEMALE NPT x 1/2" FEMALE NPT	NFB	NFD	2"	1 3/8"
15-21NFCNFD	15,000	3/8" FEMALE NPT x 1/2" FEMALE NPT	NFC	NFD	2"	1 3/8"

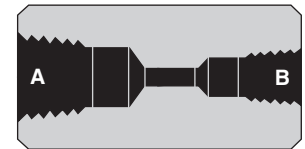

## Adapters: Male to Male NPT

Catalog No.	Pressure Rating psi	Connections	A	B	Length	Hex Size
15-21NMANMA	15,000	1/8" MALE NPT x 1/8" MALE NPT	NMA	NMA	1 3/4"	1 1/2"
15-21NMBNMB	15,000	1/4" MALE NPT x 1/4" MALE NPT	NMB	NMB	1 7/8"	5/8"
15-21NMCNMC	15,000	3/8" MALE NPT x 3/8" MALE NPT	NMC	NMC	2"	3/4"
15-21NMDNMD	15,000	1/2" MALE NPT x 1/2" MALE NPT	NMD	NMD	2 1/8"	1"
10-21NMFNMF	10,000	3/4" MALE NPT x 3/4" MALE NPT	NMF	NMF	2 3/8"	1 1/8"
10-21NMHNMH	10,000	1" MALE NPT x 1" MALE NPT	NMH	NMH	2 5/8"	1 3/8"
15-21NMBNMC	15,000	1/4" MALE NPT x 3/8" MALE NPT	NMB	NMC	2"	3/4"
15-21NMBNMD	15,000	1/4" MALE NPT x 1/2" MALE NPT	NMB	NMD	2"	7/8"
15-21NMCNMD	15,000	3/8" MALE NPT x 1/2" MALE NPT	NMC	NMD	2"	1"



**12**

# Accessories

## NPT Fittings

### Adapters: Female to Male NPT

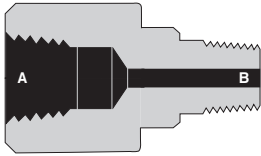

Catalog No.	Pressure Rating psi	Connections	A	B	Length	Hex Size
15-21NFANMA	15,000	1/8" FEMALE NPT x 1/8" MALE NPT	NFA	NMA	1 1/2"	3/4"
15-21NFANMB	15,000	1/8" FEMALE NPT x 1/4" MALE NPT	NFA	NMB	1 3/4"	3/4"
15-21NFANMC	15,000	1/8" FEMALE NPT x 3/8" MALE NPT	NFA	NMC	1 5/8"	3/4"
15-21NFANMD	15,000	1/8" FEMALE NPT x 1/2" MALE NPT	NFA	NMD	1 3/4"	7/8"
15-21NFBNMA	15,000	1/4" FEMALE NPT x 1/8" MALE NPT	NFB	NMA	1 5/8"	3/4"
15-21NFBNMB	15,000	1/4" FEMALE NPT x 1/4" MALE NPT	NFB	NMB	1 5/8"	1"
15-21NFBNMC	15,000	1/4" FEMALE NPT x 3/8" MALE NPT	NFB	NMC	1 5/8"	1"
15-21NFBNMD	15,000	1/4" FEMALE NPT x 1/2" MALE NPT	NFB	NMD	1 3/4"	1"
15-21NFCNMB	15,000	3/8" FEMALE NPT x 1/4" MALE NPT	NFC	NMB	1 7/8"	1"
15-21NFCNMD	15,000	3/8" FEMALE NPT x 1/2" MALE NPT	NFC	NMD	1 3/4"	1"
15-21NFDNMA	15,000	1/2" FEMALE NPT x 1/8" MALE NPT	NFD	NMA	2"	1 3/8"
15-21NFDNMB	15,000	1/2" FEMALE NPT x 1/4" MALE NPT	NFD	NMB	2"	1 3/8"
15-21NFDNMC	15,000	1/2" FEMALE NPT x 3/8" MALE NPT	NFD	NMC	1 3/4"	1 3/8"
15-21NFDNMD	15,000	1/2" FEMALE NPT x 1/2" MALE NPT	NFD	NMD	2 1/4"	1 1/8"
10-21NFFNMD	10,000	3/4" FEMALE NPT x 1/2" MALE NPT	NFF	NMD	2 3/8"	1 3/8"
10-21NFFNMH	10,000	3/4" FEMALE NPT x 1" MALE NPT	NFF	NMH	2 3/8"	1 3/8"
10-21NFFHMD	10,000	1" FEMALE NPT x 1/2" MALE NPT	NFH	NMD	2 3/4"	1 7/8"
10-21NFFHMF	10,000	1" FEMALE NPT x 3/4" MALE NPT	NFH	NMF	2 3/4"	1 7/8"



## Hose Fittings

We now offer a line of hose adapters designed to easily and safely mate with standard type "M" fittings. Our new hose adapters are rated to the maximum working pressure of the hose or hose-end connection. Our hose fittings are constructed of 316 cold-worked stainless steel with other materials available. HiP maintains an inventory of these fittings for quick ship requirements.

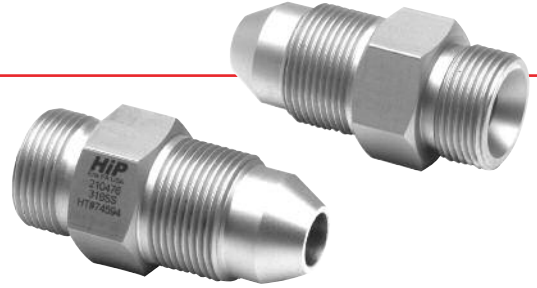

## High Pressure to Hose

Catalog No.	Pressure Rating psi	Connections	A	B	Length	Hex Size
40-21HM4HA9	40,000	1/4" H.P. x 9/16" HOSE	HM4	9/16"	1 3/4"	3/4"
30-21HM4HA12	30,000	1/4" H.P. x 3/4" HOSE	HM4	3/4"	1 7/8"	7/8"
26-21HM4HA16	26,000	1/4" H.P. x 1" HOSE	HM4	1"	2"	1 1/8"
40-21HM6HA9	40,000	3/8" H.P. x 9/16" HOSE	HM6	9/16"	2"	7/8"
30-21HM6HA12	30,000	3/8" H.P. x 3/4" HOSE	HM6	3/4"	2 1/8"	7/8"
26-21HM6HA16	26,000	3/8" H.P. x 1" HOSE	HM6	1"	2 1/4"	1 1/8"
40-21HM9HA9	40,000	9/16" H.P. x 9/16" HOSE	HM9	9/16"	2 1/4"	1 1/8"
30-21HM9HA12	30,000	9/16" H.P. x 3/4" HOSE	HM9	3/4"	2 3/8"	1 1/8"
26-21HM9HA16	26,000	9/16" H.P. x 1" HOSE	HM9	1"	2 3/8"	1 1/8"

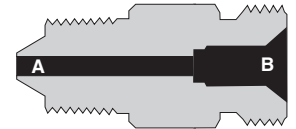

## Medium Pressure to Hose

Catalog No.	Pressure Rating psi	Connections	A	B	Length	Hex Size
20-21LM4HA9	20,000	1/4" M.P. x 9/16" HOSE	LM4	9/16"	1 7/8"	3/4"
20-21LM4HA12	20,000	1/4" M.P. x 3/4" HOSE	LM4	3/4"	2"	1"
20-21LM4HA16	20,000	1/4" M.P. x 1" HOSE	LM4	1"	2 1/8"	1 1/8"
20-21LM6HA9	20,000	3/8" M.P. x 9/16" HOSE	LM6	9/16"	1 7/8"	3/4"
20-21LM6HA12	20,000	3/8" M.P. x 3/4" HOSE	LM6	3/4"	2"	1"
20-21LM6HA16	20,000	3/8" M.P. x 1" HOSE	LM6	1"	2 1/8"	1 1/8"
20-21LM9HA9	20,000	9/16" M.P. x 9/16" HOSE	LM9	9/16"	2 1/8"	1"
20-21LM9HA12	20,000	9/16" M.P. x 3/4" HOSE	LM9	3/4"	2 1/4"	1"
20-21LM9HA16	20,000	9/16" M.P. x 1" HOSE	LM9	1"	2 1/4"	1 1/8"
20-21LM12HA9	20,000	3/4" M.P. x 9/16" HOSE	LM12	9/16"	2 1/4"	1 1/8"
20-21LM12HA12	20,000	3/4" M.P. x 3/4" HOSE	LM12	3/4"	2 3/8"	1 1/8"
20-21LM12HA16	20,000	3/4" M.P. x 1" HOSE	LM12	1"	2 3/8"	1 1/8"
20-21LM12HA21	20,000	3/4" M.P. x 1 5/16" HOSE	LM12	1 5/16"	2 3/4"	1 1/2"
20-21LM16HA9	20,000	1" M.P. x 9/16" HOSE	LM16	9/16"	3 5/8"	1 1/8"
20-21LM16HA12	20,000	1" M.P. x 3/4" HOSE	LM16	3/4"	3 3/4"	1 1/8"
20-21LM16HA16	20,000	1" M.P. x 1" HOSE	LM16	1"	3 3/4"	1 1/8"
20-21LM16HA21	20,000	1" M.P. x 1 5/16" HOSE	LM16	1 5/16"	4"	1 1/2"

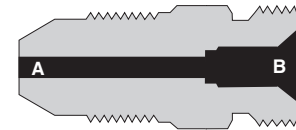

12

# Accessories

## NPT to Hose

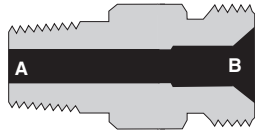

Catalog No.	Pressure Rating psi	Connections	A	B	Length	Hex Size
15-21NMBHA9	15,000	1/4" NPT MALE x 9/16" HOSE	NMB	9/16"	1 5/8"	5/8"
15-21NMBHA12	15,000	1/4" NPT MALE x 3/4" HOSE	NMB	3/4"	1 7/8"	7/8"
15-21NMBHA16	15,000	1/4" NPT MALE x 1" HOSE	NMB	1"	1 7/8"	1"
15-21NMCHA9	15,000	3/8" NPT MALE x 9/16" HOSE	NMC	9/16"	1 5/8"	3/4"
15-21NMCHA12	15,000	3/8" NPT MALE x 3/4" HOSE	NMC	3/4"	1 7/8"	7/8"
15-21NMCHA16	15,000	3/8" NPT MALE x 1" HOSE	NMC	1"	1 7/8"	1"
15-21NMDHA9	15,000	1/2" NPT MALE x 9/16" HOSE	NMD	9/16"	1 7/8"	7/8"
15-21NMDHA12	15,000	1/2" NPT MALE x 3/4" HOSE	NMD	3/4"	2"	7/8"
15-21NMDHA16	15,000	1/2" NPT MALE x 1" HOSE	NMD	1"	2"	1"
10-21NMFHA12	10,000	3/4" NPT MALE x 3/4" HOSE	NMF	3/4"	2"	1 1/8"
10-21NMFHA16	10,000	3/4" NPT MALE x 1" HOSE	NMF	1"	2"	1 1/8"
10-21NMHHA16	10,000	1" NPT MALE x 1" HOSE	NMH	1"	2 1/4"	1 3/8"

## Hose to Hose

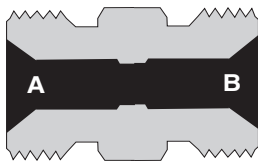

Catalog No.	Pressure Rating psi	Connections	A	B	Length	Hex Size
26-21HA9HA9	26,000	9/16" HOSE x 9/16" HOSE	9/16"	9/16"	1 1/2"	3/4"
26-21HA9HA12	26,000	9/16" HOSE x 3/4" HOSE	9/16"	3/4"	1 5/8"	7/8"
26-21HA9HA16	26,000	9/16" HOSE x 1" HOSE	9/16"	1"	1 3/4"	1 1/8"
26-21HA12HA12	26,000	3/4" HOSE x 3/4" HOSE	3/4"	3/4"	1 3/4"	7/8"
26-21HA12HA16	26,000	3/4" HOSE x 1" HOSE	3/4"	1"	1 7/8"	1 1/8"
26-21HA16HA16	26,000	1" HOSE x 1" HOSE	1"	1"	1 7/8"	1 1/8"

## Straight Couplings Reducer Couplings

A complete range of couplings is offered for flexibility in going from tube to tube and from tube to pipe.

All standard coupling bodies are made from high tensile 316 stainless steel. Standard tubing glands and collars (sleeves) are provided with adapters unless otherwise specified.

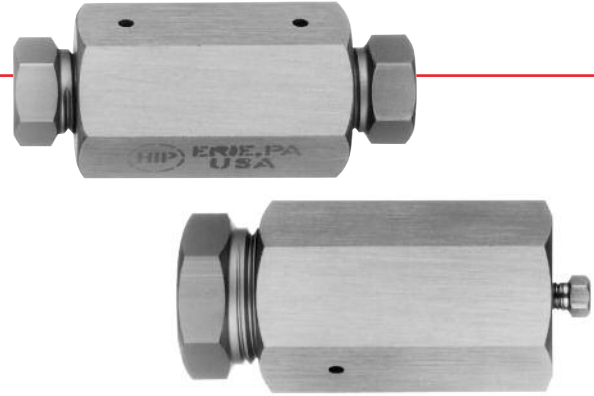

## Taper Seal Straight Couplings

Catalog No.	Pressure Rating psi	Connections	A	B	Length	Hex Size
15-21AF1	15,000	1/16" O.D. TUBING	AF1	AF1	1"	3/8"
15-21AF2	15,000	1/8" O.D. TUBING	AF2	AF2	1 1/8"	3/4"
10-21AF4	10,000	1/4" O.D. TUBING	AF4	AF4	1 3/4"	1"
10-21AF6	10,000	3/8" O.D. TUBING	AF6	AF6	1 3/4"	1"

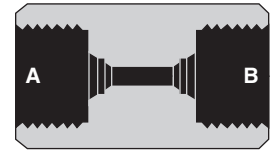

## Female Taper Seal to Female NPT

Catalog No.	Pressure Rating psi	Connections	A	B	Length	Hex Size
15-21AF1NFA	15,000	1/16" O.D. TUBE TO 1/8" NPT	AF1	NFA	1 1/8"	5/8"
15-21AF1NFB	15,000	1/16" O.D. TUBE TO 1/4" NPT	AF1	NFB	1 1/8"	3/4"
15-21AF1NFC	15,000	1/16" O.D. TUBE TO 3/8" NPT	AF1	NFC	1 3/8"	1"
15-21AF1NFD	15,000	1/16" O.D. TUBE TO 1/2" NPT	AF1	NFD	1 3/4"	1 1/8"
15-21AF2NFA	15,000	1/8" O.D. TUBE TO 1/8" NPT	AF2	NFA	1 1/4"	5/8"
15-21AF2NFB	15,000	1/8" O.D. TUBE TO 1/4" NPT	AF2	NFB	1 1/4"	3/4"
15-21AF2NFC	15,000	1/8" O.D. TUBE TO 3/8" NPT	AF2	NFC	1 1/2"	1"
15-21AF2NFD	15,000	1/8" O.D. TUBE TO 1/2" NPT	AF2	NFD	1 3/4"	1 1/8"
10-21AF4NFA	10,000	1/4" O.D. TUBE TO 1/8" NPT	AF4	NFA	1 5/8"	1"
10-21AF4NFB	10,000	1/4" O.D. TUBE TO 1/4" NPT	AF4	NFB	1 3/4"	1"
10-21AF4NFC	10,000	1/4" O.D. TUBE TO 3/8" NPT	AF4	NFC	1 7/8"	1"
10-21AF4NFD	10,000	1/4" O.D. TUBE TO 1/2" NPT	AF4	NFD	1 7/8"	1 1/8"
10-21AF4NFF	10,000	1/4" O.D. TUBE TO 3/4" NPT	AF4	NFF	2 3/8"	1 3/8"
10-21AF4NFH	10,000	1/4" O.D. TUBE TO 1" NPT	AF4	NFH	2 5/8"	1 7/8"
10-21AF6NFA	10,000	3/8" O.D. TUBE TO 1/8" NPT	AF6	NFA	1 5/8"	1"
10-21AF6NFB	10,000	3/8" O.D. TUBE TO 1/4" NPT	AF6	NFB	1 3/4"	1"
10-21AF6NFC	10,000	3/8" O.D. TUBE TO 3/8" NPT	AF6	NFC	1 7/8"	1"
10-21AF6NFD	10,000	3/8" O.D. TUBE TO 1/2" NPT	AF6	NFD	2 1/8"	1 1/8"
10-21AF6NFF	10,000	3/8" O.D. TUBE TO 3/4" NPT	AF6	NFF	2 3/8"	1 3/8"
10-21AF6NFH	10,000	3/8" O.D. TUBE TO 1" NPT	AF6	NFH	2 5/8"	1 7/8"

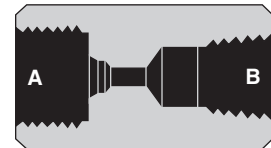

# Accessories

## Female Taper Seal to Female High Pressure

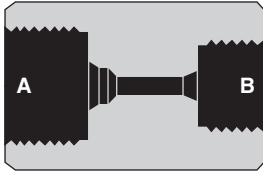

Catalog No.	Pressure Rating psi	Connections	A	B	Length	Hex Size
15-21AF1HF2	15,000	1/16" O.D. TUBE TO 1/8" H.P.	AF1	HF2	1 1/8"	5/8"
15-21AF1HF4	15,000	1/16" O.D. TUBE TO 1/4" H.P.	AF1	HF4	1 1/4"	3/4"
15-21AF1HF6	15,000	1/16" O.D. TUBE TO 3/8" H.P.	AF1	HF6	1 3/8"	1"
15-21AF1HF9	15,000	1/16" O.D. TUBE TO 9/16" H.P.	AF1	HF9	2 7/8"	1 3/8"
15-21AF2HF2	15,000	1/8" O.D. TUBE TO 1/8" H.P.	AF2	HF2	1 1/8"	3/4"
15-21AF2HF4	15,000	1/8" O.D. TUBE TO 1/4" H.P.	AF2	HF4	1 1/4"	3/4"
15-21AF2HF6	15,000	1/8" O.D. TUBE TO 3/8" H.P.	AF2	HF6	1 7/8"	1"
15-21AF2HF9	15,000	1/8" O.D. TUBE TO 9/16" H.P.	AF2	HF9	2 7/8"	1 3/8"
10-21AF4HF2	10,000	1/4" O.D. TUBE TO 1/8" H.P.	AF4	HF2	1 3/8"	1"
10-21AF4HF4	10,000	1/4" O.D. TUBE TO 1/4" H.P.	AF4	HF4	1 1/2"	1"
10-21AF4HF6	10,000	1/4" O.D. TUBE TO 3/8" H.P.	AF4	HF6	1 7/8"	1"
10-21AF4HF9	10,000	1/4" O.D. TUBE TO 9/16" H.P.	AF4	HF9	2 7/8"	1 3/8"
10-21AF6HF2	10,000	1/4" O.D. TUBE TO 1/8" H.P.	AF6	HF2	1 1/2"	1"
10-21AF6HF4	10,000	3/8" O.D. TUBE TO 1/4" H.P.	AF6	HF4	1 3/4"	1"
10-21AF6HF6	10,000	3/8" O.D. TUBE TO 3/8" H.P.	AF6	HF6	1 7/8"	1"
10-21AF6HF9	10,000	3/8" O.D. TUBE TO 9/16" H.P.	AF6	HF9	2 3/8"	1 3/8"

## Taper Seal Reducer Couplings

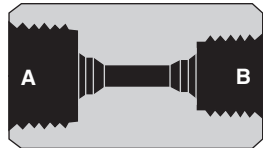

Catalog No.	Pressure Rating psi	Connections	A	B	Length	Hex Size
15-21AF1AF2	15,000	1/16" O.D. TO 1/8" O.D. TUBE	AF1	AF2	1 1/8"	5/8"
10-21AF1AF4	10,000	1/16" O.D. TO 1/4" O.D. TUBE	AF1	AF4	1 3/8"	1"
10-21AF1AF6	10,000	1/16" O.D. TO 3/8" O.D. TUBE	AF1	AF6	1 3/8"	1"
10-21AF2AF4	10,000	1/8" O.D. TO 1/4" O.D. TUBE	AF2	AF4	1 1/2"	1"
10-21AF2AF6	10,000	1/8" O.D. TO 3/8" O.D. TUBE	AF2	AF6	1 1/2"	1"
10-21AF4AF6	10,000	1/4" O.D. TO 3/8" O.D. TUBE	AF4	AF6	1 3/4"	1"

## Female Medium Pressure to Female Medium Pressure

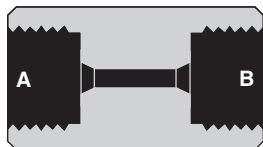

Catalog No.	Pressure Rating psi	Connections	A	B	Length	Hex Size
20-21LF4	20,000	1/4" M.P. to 1/4" M.P.	LF4	LF4	1 9/16"	5/8"
20-21LF4LF6	20,000	1/4" M.P. to 3/8" M.P.	LF4	LF6	1 3/4"	3/4"
20-21LF4LF9	20,000	1/4" M.P. to 9/16" M.P.	LF4	LF9	2 1/8"	1"
20-21LF4LF12	20,000	1/4" M.P. to 3/4" M.P.	LF4	LF12	2 1/2"	1 3/8"
20-21LF4LF16	20,000	1/4" M.P. to 1" MP	LF4	LF16	3 1/2"	1 3/4"
15-21LF4LF24	15,000	1/4" M.P. to 1 1/2" MP	LF4	LF24	4"	2 1/4"
20-21LF6	20,000	3/8" M.P. to 3/8" MP	LF6	LF6	1 3/4"	3/4"
20-21LF6LF9	20,000	3/8" M.P. to 9/16" MP	LF6	LF9	2 1/8"	1"
20-21LF6LF12	20,000	3/8" M.P. to 3/4" MP	LF6	LF12	2 1/2"	1 3/8"
20-21LF6LF16	20,000	3/8" M.P. to 1" MP	LF6	LF16	3 1/2"	1 3/4"
15-21LF6LF24	15,000	3/8" MP to 1 1/2" MP	LF6	LF24	4"	2 1/4"
20-21LF9	20,000	9/16" MP to 9/16" MP	LF9	LF9	2 1/8"	1"
20-21LF9LF12	20,000	9/16" MP to 3/4" MP	LF9	LF12	2 1/2"	1 3/8"
20-21LF9LF16	20,000	9/16" MP to 1" MP	LF9	LF16	3 1/2"	1 3/4"
15-21LF9LF24	15,000	9/16" MP to 1 1/2" MP	LF9	LF24	4"	2 1/4"
20-21LF12	20,000	3/4" MP to 3/4" MP	LF12	LF12	2 1/2"	1 3/8"
20-21LF12LF16	20,000	3/4" MP to 1" MP	LF12	LF16	3 1/2"	1 3/4"
15-21LF12LF24	15,000	3/4" MP to 1 1/2" MP	LF12	LF24	4 1/4"	2 1/4"
20-21LF16	20,000	1" MP to 1" MP	LF16	LF16	3 1/2"	1 3/4"
15-21LF16LF24	15,000	1" MP to 1 1/2" MP	LF16	LF24	4 1/2"	2 1/4"
15-21LF24	15,000	1 1/2" MP to 1 1/2" MP	LF24	LF24	5"	2 1/4"

## Couplings

### Female Medium Pressure to Female Pipe

Catalog No.	Pressure Rating psi	Connections	A	B	Length	Hex Size
20-21LF4NFA	15,000	1/4" M.P. to 1/8" NPT FEMALE	LF4	NFA	1 5/8"	3/4"
20-21LF4NFB	15,000	1/4" M.P. to 1/4" NPT FEMALE	LF4	NFB	1 5/8"	3/4"
20-21LF4NFC	15,000	1/4" M.P. to 3/8" NPT FEMALE	LF4	NFC	2"	1"
20-21LF4NFD	15,000	1/4" M.P. to 1/2" NPT FEMALE	LF4	NFD	2"	1 1/8"
10-21LF4NFF	10,000	1/4" M.P. to 3/4" NPT FEMALE	LF4	NFF	2 3/8"	1 3/8"
10-21LF4NFH	10,000	1/4" M.P. to 1" NPT FEMALE	LF4	NFH	2 5/8"	1 7/8"
20-21LF6NFA	15,000	3/8" M.P. to 1/8" NPT FEMALE	LF6	NFA	1 3/4"	3/4"
20-21LF6NFB	15,000	3/8" M.P. to 1/4" NPT FEMALE	LF6	NFB	1 3/4"	3/4"
20-21LF6NFC	15,000	3/8" M.P. to 3/8" NPT FEMALE	LF6	NFC	2 1/8"	1"
20-21LF6NFD	15,000	3/8" M.P. to 1/2" NPT FEMALE	LF6	NFD	2 1/8"	1 1/8"
10-21LF6NFF	10,000	3/8" M.P. to 3/4" NPT FEMALE	LF6	NFIF	2 3/8"	1 3/8"
10-21LF6NFH	10,000	3/8" M.P. to 1" NPT FEMALE	LF6	NFH	2 3/4"	1 7/8"
20-21LF9NFA	15,000	9/16" M.P. to 1/8" NPT FEMALE	LF9	NFA	2 1/8"	1"
20-21LF9NFB	15,000	9/16" M.P. to 1/4" NPT FEMALE	LF9	NFB	2 1/8"	1"
20-21LF9NFC	15,000	9/16" M.P. to 3/8" NPT FEMALE	LF9	NFC	2 1/8"	1"
20-21LF9NFD	15,000	9/16" M.P. to 1/2" NPT FEMALE	LF9	NFD	2 1/4"	1 1/8"
10-21LF9NFF	10,000	9/16" M.P. to 3/4" NPT FEMALE	LF9	NFF	2 1/2"	1 3/8"
10-21LF9NFH	10,000	9/16" M.P. to 1" NPT FEMALE	LF9	NFH	2 7/8"	1 7/8"
20-21LF12NFA	15,000	3/4" M.P. to 1/8" NPT FEMALE	LF12	NFA	2 1/2"	1 3/8"
20-21LF12NFB	15,000	3/4" M.P. to 1/4" NPT FEMALE	LF12	NFB	2 1/2"	1 3/8"
20-21LF12NFC	15,000	3/4" M.P. to 3/8" NPT FEMALE	LF12	NFC	2 1/2"	1 3/8"
20-21LF12NFD	15,000	3/4" M.P. to 1/2" NPT FEMALE	LF12	NFD	2 1/2"	1 3/8"
10-21LF12NFF	10,000	3/4" M.P. to 3/4" NPT FEMALE	LF12	NFF	2 3/4"	1 1/2"
10-21LF12NFH	10,000	3/4" M.P. to 1" NPT FEMALE	LF12	NFH	3"	1 7/8"
20-21LF16NFA	15,000	1" M.P. to 1/8" NPT FEMALE	LF16	NFA	3"	1 3/4"
20-21LF16NFB	15,000	1" M.P. to 1/4" NPT FEMALE	LF16	NFB	3"	1 3/4"
20-21LF16NFC	15,000	1" M.P. to 3/8" NPT FEMALE	LF16	NFC	3"	1 3/4"
20-21LF16NFD	15,000	1" M.P. to 1/2" NPT FEMALE	LF16	NFD	3"	1 3/4"
10-21LF16NFF	10,000	1" M.P. to 3/4" NPT FEMALE	LF16	NFF	3 1/4"	1 3/4"
10-21LF16NFH	10,000	1" M.P. to 1" NPT FEMALE	LF16	NFH	3 1/4"	1 3/4"

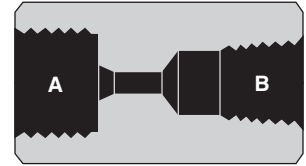

12

### Medium Pressure Straight Couplings

Catalog No.	Pressure Rating psi	Connections	A	B	Length	Hex Size
20-21LF4	20,000	1/4" O.D. TUBING	LF4	LF4	1 9/16"	5/8"
20-21LF6	20,000	3/8" O.D. TUBING	LF6	LF6	1 3/4"	3/4"
20-21LF9	20,000	9/16" O.D. TUBING	LF9	LF9	2 1/8"	1"
20-21LF12	20,000	3/4" O.D. TUBING	LF12	LF12	2 1/2"	1 3/8"
20-21LF16	20,000	1" O.D. TUBING	LF16	LF16	3 1/2"	1 3/4"
15-21LF24	15,000	1 1/2" O.D. TUBING	LF24	LF24	5"	2 1/4"

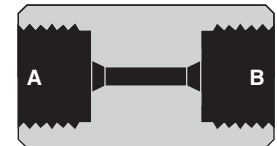

# Accessories

## Couplings

### Female Medium Pressure to Female High Pressure

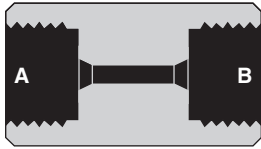

Catalog No.	Pressure Rating psi	Connections	A	B	Length	Hex Size
20-21LF4HF4	20,000	1/4" M.P. to 1/4" H.P.	LF4	HF4	1 5/8"	3/4"
20-21LF4HF6	20,000	1/4" M.P. to 3/8" H.P.	LF4	HF6	1 7/8"	1"
20-21LF4HF9	20,000	1/4" M.P. to 9/16" H.P.	LF4	HF9	2 3/8"	1 3/8"
20-21LF6HF4	20,000	3/8" M.P. to 1/4" H.P.	LF6	HF4	1 3/4"	3/4"
20-21LF6HF6	20,000	3/8" M.P. to 3/8" H.P.	LF6	HF6	1 7/8"	1"
20-21LF6HF9	20,000	3/8" M.P. to 9/16" H.P.	LF6	HF9	2 3/8"	1 3/8"
20-21LF9HF4	20,000	9/16" M.P. to 1/4" H.P.	LF9	HF4	2 1/8"	1"
20-21LF9HF6	20,000	9/16" M.P. to 3/8" H.P.	LF9	HF6	2 1/8"	1"
20-21LF9HF9	20,000	9/16" M.P. to 9/16" H.P.	LF9	HF9	2 3/8"	1 3/8"
20-21LF12HF4	20,000	3/4" M.P. to 1/4" H.P.	LF12	HF4	2 1/2"	1 3/8"
20-21LF12HF6	20,000	3/4" M.P. to 3/8" H.P.	LF12	HF6	2 1/2"	1 3/8"
20-21LF12HF9	20,000	3/4" M.P. to 9/16" H.P.	LF12	HF9	2 1/2"	1 3/8"
* 20-21LF16HF4	20,000	1" M.P. to 1/4" H.P.	HF16	HF4	3 1/2"	1 3/4"
* 20-21LF16HF6	20,000	1" M.P. to 3/8" H.P.	HF16	HF6	3 1/2"	1 3/4"
* 20-21LF16HF9	20,000	1" M.P. to 9/16" H.P.	HF16	HF9	3 1/2"	1 3/4"

\* Can be rated to 30,000 psi if used with 1" O.D. x 7/16" I.D. tubing.

### High Pressure Straight Couplings

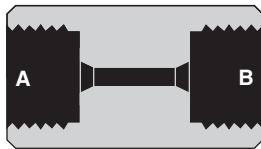

Catalog No.	Pressure Rating psi	Connections	A	B	Length	Hex Size
60-21HF2	60,000	1/8" O.D. TUBING	HF2	HF2	1 1/8"	3/4"
60-21HF4	60,000	1/4" O.D. TUBING	HF4	HF4	1 3/4"	1"
60-21HF6	60,000	3/8" O.D. TUBING	HF6	HF6	2"	1"
60-21HF9	60,000	9/16" O.D. TUBING	HF9	HF9	2 3/8"	1 3/8"
30-21HF16	30,000	1" O.D. TUBING	HF16	HF16	3 1/2"	1 3/4"

### High Pressure Reducer Couplings

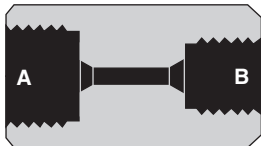

Catalog No.	Pressure Rating psi	Connections	A	B	Length	Hex Size
60-21HF2HF4	60,000	1/8" O.D. TO 1/4" O.D. TUBE	HF2	HF4	1 1/4"	3/4"
60-21HF2HF6	60,000	1/8" O.D. TO 3/8" O.D. TUBE	HF2	HF6	1 5/8"	1"
60-21HF2HF9	60,000	1/8" O.D. TO 9/16" O.D. TUBE	HF2	HF9	1 3/4"	1 3/8"
60-21HF4HF6	60,000	1/4" O.D. TO 3/8" O.D. TUBE	HF4	HF6	1 5/8"	1"
60-21HF4HF9	60,000	1/4" O.D. TO 9/16" O.D. TUBE	HF4	HF9	1 3/4"	1 3/8"
60-21HF6HF9	60,000	3/8" O.D. TO 9/16" O.D. TUBE	HF6	HF9	2"	1 3/8"



## Female High Pressure to Female NPT Pipe

Catalog No.	Pressure Rating psi	Connections	A	B	Length	Hex Size
30-21HF2NFA	15,000	1/8" O.D. TUBE TO 1/8" NPT	HF2	NFA	1 1/2"	3/4"
30-21HF2NFB	15,000	1/8" O.D. TUBE TO 1/4" NPT	HF2	NFB	1 1/2"	3/4"
30-21HF2NFC	15,000	1/8" O.D. TUBE TO 3/8" NPT	HF2	NFC	1 1/2"	1"
30-21HF2NFD	15,000	1/8" O.D. TUBE TO 1/2" NPT	HF2	NFD	1 3/4"	1 1/8"
10-21HF2NFF	10,000	1/8" O.D. TUBE TO 3/4" NPT	HF2	NFF	2"	1 3/8"
10-21HF2NFH	10,000	1/8" O.D. TUBE TO 1" NPT	HF2	NFH	2 1/2"	1 3/4"
30-21HF4NFA	15,000	1/4" O.D. TUBE TO 1/8" NPT	HF4	NFA	1 1/2"	1"
30-21HF4NFB	15,000	1/4" O.D. TUBE TO 1/4" NPT	HF4	NFB	1 1/2"	1"
30-21HF4NFC	15,000	1/4" O.D. TUBE TO 3/8" NPT	HF4	NFC	1 7/8"	1"
30-21HF4NFD	15,000	1/4" O.D. TUBE TO 1/2" NPT	HF4	NFD	1 7/8"	1 1/8"
10-21HF4NFF	10,000	1/4" O.D. TUBE TO 3/4" NPT	HF4	NFF	2"	1 3/8"
10-21HF4NFH	10,000	1/4" O.D. TUBE TO 1" NPT	HF4	NFH	2 1/2"	1 3/4"
30-21HF6NFA	15,000	3/8" O.D. TUBE TO 1/8" NPT	HF6	NFA	1 7/8"	1"
30-21HF6NFB	15,000	3/8" O.D. TUBE TO 1/4" NPT	HF6	NFB	1 7/8"	1"
30-21HF6NFC	15,000	3/8" O.D. TUBE TO 3/8" NPT	HF6	NFC	1 7/8"	1"
30-21HF6NFD	15,000	3/8" O.D. TUBE TO 1/2" NPT	HF6	NFD	1 7/8"	1 1/8"
10-21HF6NFF	10,000	3/8" O.D. TUBE TO 3/4" NPT	HF6	NFF	2 1/8"	1 3/8"
10-21HF6NFH	10,000	3/8" O.D. TUBE TO 1" NPT	HF6	NFH	2 5/8"	1 7/8"
30-21HF9NFA	15,000	9/16" O.D. TUBE TO 1/8" NPT	HF9	NFA	2 3/8"	1 3/8"
30-21HF9NFB	15,000	9/16" O.D. TUBE TO 1/4" NPT	HF9	NFB	2 3/8"	1 3/8"
30-21HF9NFC	15,000	9/16" O.D. TUBE TO 3/8" NPT	HF9	NFC	2 3/8"	1 3/8"
30-21HF9NFD	15,000	9/16" O.D. TUBE TO 1/2" NPT	HF9	NFD	2 3/8"	1 3/8"
10-21HF9NFF	10,000	9/16" O.D. TUBE TO 3/4" NPT	HF9	NFF	2 3/8"	1 3/8"
10-21HF9NFH	10,000	9/16" O.D. TUBE TO 1" NPT	HF9	NFH	2 5/8"	2"

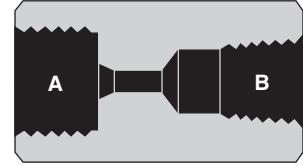

High Pressure Equipment offers an extensive selection of couplings and adapters to meet virtually every requirement.

**12**

# Accessories

## Thermocouple Adapters

The  $\frac{1}{16}$ " O.D. and  $\frac{1}{8}$ " O.D. tubing sizes of the Taper Seal connections are ideally suited for use with thermocouples for pressures up to 15,000 psi.

These connectors do not bite into the outer wall of the thermocouple, but rather clamp onto the tubing (or thermocouple) similar to a machine collet. A thread lubricant is recommended on the gland nut when initially making up the connection, but such lubrication can later be removed if desired. Material is high tensile 316 stainless steel. Standard glands and sleeves are provided unless otherwise specified.

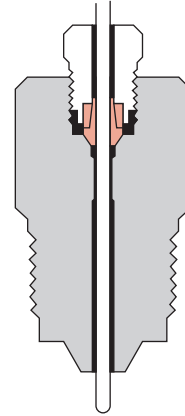

### Adapters for $\frac{1}{16}$ " TCs

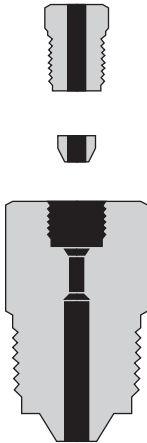

Catalog No.	Pressure Rating psi	Male End of Adapter	Length	Hex Size
15-21AF1AM2-T	15,000	$\frac{1}{8}$ " TAPER SEAL	$\frac{7}{8}$ "	$\frac{1}{2}$ "
10-21AF1AM4-T	10,000	$\frac{1}{4}$ " TAPER SEAL	$1\frac{1}{4}$ "	$\frac{3}{4}$ "
10-21AF1AM6-T	10,000	$\frac{3}{8}$ " TAPER SEAL	$1\frac{1}{4}$ "	$\frac{3}{4}$ "
15-21AF1HM2-T	15,000	$\frac{1}{8}$ " HIGH PRESSURE	$\frac{7}{8}$ "	$\frac{1}{2}$ "
15-21AF1HM4-T	15,000	$\frac{1}{4}$ " HIGH PRESSURE	$1\frac{1}{4}$ "	$\frac{5}{8}$ "
15-21AF1HM6-T	15,000	$\frac{3}{8}$ " HIGH PRESSURE	$1\frac{3}{4}$ "	$\frac{3}{4}$ "
15-21AF1HM9-T	15,000	$\frac{9}{16}$ " HIGH PRESSURE	$2\frac{1}{8}$ "	$1\frac{1}{8}$ "
15-21AF1NMA-T	15,000	$\frac{1}{8}$ " NPT	1"	$\frac{1}{2}$ "
15-21AF1NMB-T	15,000	$\frac{1}{4}$ " NPT	$1\frac{1}{4}$ "	$\frac{5}{8}$ "
15-21AF1NMC-T	15,000	$\frac{3}{8}$ " NPT	$1\frac{3}{8}$ "	$\frac{3}{4}$ "
15-21AF1NMD-T	15,000	$\frac{1}{2}$ " NPT	$1\frac{3}{4}$ "	1"
10-21AF1NMF-T	10,000	$\frac{3}{4}$ " NPT	$1\frac{7}{8}$ "	$1\frac{3}{8}$ "
10-21AF1NMH-T	10,000	1" NPT	$1\frac{5}{8}$ "	$1\frac{3}{8}$ "

### Adapters for $\frac{1}{8}$ " TCs

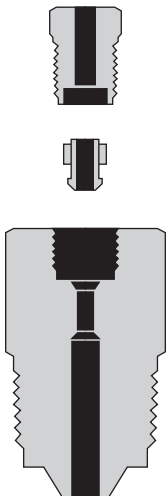

Catalog No.	Pressure Rating psi	Male End of Adapter	Length	Hex Size
10-21AF2AM4-T	10,000	$\frac{1}{4}$ " TAPER SEAL	$1\frac{1}{4}$ "	$\frac{3}{4}$ "
10-21AF2AM6-T	10,000	$\frac{3}{8}$ " TAPER SEAL	$1\frac{1}{4}$ "	$\frac{3}{4}$ "
15-21AF2HM4-T	15,000	$\frac{1}{4}$ " HIGH PRESSURE	$1\frac{1}{4}$ "	$\frac{5}{8}$ "
15-21AF2HM6-T	15,000	$\frac{3}{8}$ " HIGH PRESSURE	$1\frac{3}{4}$ "	$\frac{3}{4}$ "
15-21AF2HM9-T	15,000	$\frac{9}{16}$ " HIGH PRESSURE	$2\frac{1}{8}$ "	$1\frac{1}{8}$ "
15-21AF2NMA-T	15,000	$\frac{1}{8}$ " NPT	$1\frac{1}{4}$ "	$\frac{3}{4}$ "
15-21AF2NMB-T	15,000	$\frac{1}{4}$ " NPT	$1\frac{1}{4}$ "	$\frac{5}{8}$ "
15-21AF2NMC-T	15,000	$\frac{3}{8}$ " NPT	$1\frac{3}{8}$ "	$\frac{3}{4}$ "
15-21AF2NMD-T	15,000	$\frac{1}{2}$ " NPT	$1\frac{3}{4}$ "	1"
10-21AF2NMF-T	10,000	$\frac{3}{4}$ " NPT	$1\frac{7}{8}$ "	$1\frac{3}{8}$ "
10-21AF2NMH-T	10,000	1" NPT	$1\frac{5}{8}$ "	$1\frac{3}{8}$ "

# Custom Manifolds

## Save installation time, space and reduce potential leak points

High Pressure Equipment designs and manufactures custom pressure manifolds to meet nearly any specific installation, layout and pressure requirement. HiP pressure manifolds are an excellent option to minimize space requirements and reduce the installation time necessary to plumb a pressure system. In addition, custom manifolds reduce the number of potential leak points because of the reduced number of components used in a system.

HiP custom manifolds are available in a wide range of connection sizes and can accommodate pressures from 5,000 up to 60,000 psi, making them an ideal option within low, medium, NPT and high pressure systems. These manifolds also are available in a range of materials and configurations to address demanding environmental and layout requirements, as well as transitions in line sizes and tubing pressures.



## Spec Your Custom Manifold

Please use the drawings and questions below to provide us with the critical parameters for your manifold. We will then provide you a quote and delivery time.

- How many Ports? Top\_\_\_ Bottom\_\_\_ Front\_\_\_ Side\_\_\_
- What Type and Size connection? (circle selection)  
 Taper Seal: AF2, AF4, AF6  
 Medium Pressure: LF4, LF6, LF9, LF12, LF16  
 High Pressure: HF2, HF4, HF6, HF16  
 NPT: 1/4" FNPT, 3/4" FNPT, 1/2" FNPT, 3/4" FNPT, 1" FNPT  
 Other: BSTP, BSPP, SAE
- Mounting Holes? Yes\_\_\_ No\_\_\_
- Special Spacing required? Yes\_\_\_ No\_\_\_  
 If Yes, Spacing (inches)\_\_\_\_\_
- Pressure Rating? \_\_\_\_\_ psi
- Temperature Rating? \_\_\_\_\_ °F
- Material Standard is 316 SS, OK\_\_\_  
 No, special material required\_\_\_\_\_

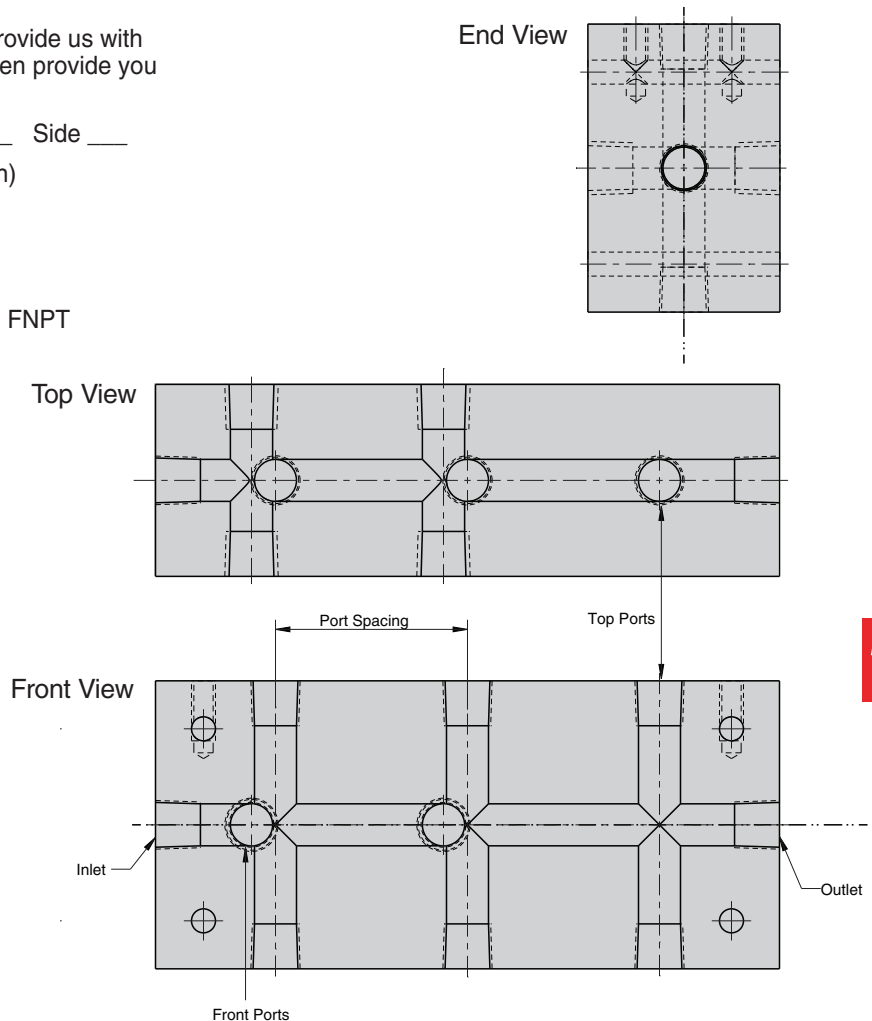

**13**

# Astragauge High Pressure Gauges

High Pressure Equipment has added the full line of ASTRAGAUGE high pressure gauges, ROTASEAL high pressure swivels and high pressure Gauge Snubbers to their product family. ASTRAGAUGE has established a reputation for producing highly accurate and reliable bourdon-tube style gauges for pressures up to 150,000 psi.

## ASTRAGAUGE Features

- Wall or flush mounting
- Bottom or back connected
- 6" diameter black-on-white dial
- All "wetted" parts 316 SS
- Accuracy - 1/2 of 1% ascending pressure
- 14 Ranges from 7,500 PSI to 150,000 PSI
- Polycarbonate front window
- 316 SS multiturn (10 turns) bourdon element (Ni-Span "C" for 150,000 PSI)



- Turret type heavy duty sealed aluminum case
- Oxygen, gas and water service
- PSI: Kg/Cm<sup>2</sup>; megapascals; bars

## Astragauge High Pressure Gauges

Range psi	Connection 1/4" HP	Astragauge Part No.		HiP Part No. Surface Mount	Division psi
		Panel Mount	Surface Mount		
7,500	Bottom	W-7-1	F-7-1		50
	Back	WB-7-1	FB-7-1		
10,000	Bottom	W-10-1	F-10-1		100
	Back	WB-10-1	FB-10-1		
15,000	Bottom	W-15-1	F-15-1		100
	Back	WB-15-1	FB-15-1		
20,000	Bottom	W-20-1	F-20-1	6PG20C	200
	Back	WB-20-1	FB-20-1	—	
30,000	Bottom	W-30-1	F-30-1	6PG30C	250
	Back	WB-30-1	FB-30-1	—	
40,000	Bottom	W-40-1	F-40-1		500
	Back	WB-40-1	FB-40-1		
50,000	Bottom	W-50-1	F-50-1	6PG50	500
	Back	WB-50-1	FB-50-1	—	
60,000	Bottom	W-60-1	F-60-1		500
	Back	WB-60-1	FB-60-1		
75,000	Bottom	W-75-1	F-75-1		500
	Back	WB-75-1	FB-75-1		
80,000	Bottom	W-80-1	F-80-1		1,000
	Back	WB-80-1	FB-80-1		
100,000	Bottom	W-100-1	F-100-1		1,000
<b>3/8" HP</b>					
75,000	Bottom	W-75-2	F-75-2	6PG75	500
100,000	Bottom	W-100-2	F-100-2	6PG100	1,000
150,000	Bottom	W-150-2V	F-150-2V	6PG150	1,000

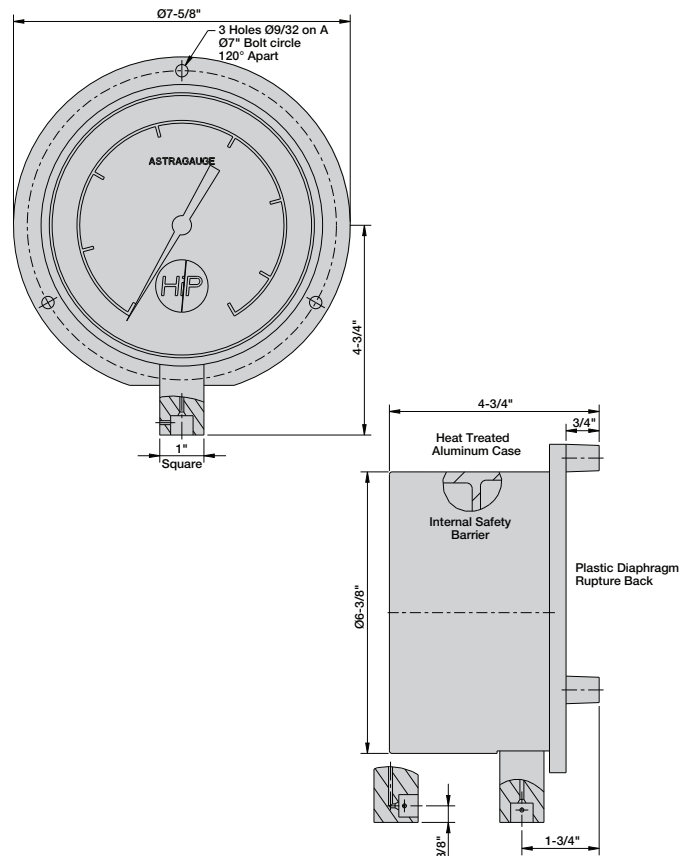

## Astragaugue

### Accuracy

The standard accuracy is 1/2 of 1%. All gauges are calibrated against NIST traceable dead weight testers accurate to 1/10 of 1% or against a certified master gauge. Gauges are checked at a minimum of five (5) points.

### Element

Of specially cold drawn and cold formed 316 SS. This multiturn (10 turns) helical Bourdon tube gives longer life and provides better accuracy. It is used in all ranges to 100,000 PSI. Ni-Span "C" is used for 150,000 PSI. Element has mechanically sealed end to permit cleaning when required (as for oxygen service). No soldered or welded joints. Available in 14 ranges as shown in table.

### Pressure Test

All gauges are "over-pressurized" to 130% of the rated pressure (except for 150,000 which is proof tested at 180,000 PSI) and cycled to full pressure prior to calibrating.

### Movement

For best accuracy and smoothness of operation, a special bronze movement is used. Zero adjustment is achieved by means of a micro pointer gear arrangement. The range can be field adjusted from the outside of the case, provided a suitable calibration standard is available.

### Dial

PSI/MPa dual dial is standard scale. Special orders are available. (i.e. KgCm<sup>2</sup>, Bar, MPA)

### Socket Adapter and Special Openings

We can offer (on special order) sockets for (7,500 - 30,000) 1/2" NPT or 1/2" NPS (straight) but caution that at the higher pressures it will be difficult to achieve leak free joints.

### Safety

The case is the turret type and of heat treated high tensile aluminum having a heavy section between the viewer and the Bourdon element, thus providing safety in case of element failure. The standard dial face is an easily removable polycarbonate plastic, sealed with a Tetra-Seal gasket. A light, plastic, frangible diaphragm back sealed to the case by an "O" ring, provides safety in case of element failure, proven by tests to be the safest possible design.

### Options

Maximum Pressure Indicator, Liquid Filled, Astrattract (high-low contacts) and Special Order Dial.

### Pressure Connections

Standard is 1/4" high pressure (1/4" HP, F250C, H F-4) available in bottom or back connected in all ranges up to 100,000 PSI. For the higher pressure ranges (e.g. 50,000 to 150,000 PSI) we can offer our 2V connection suitable for 3/8" OD x 1/16" ID tubing.



### 1/4" High Pressure

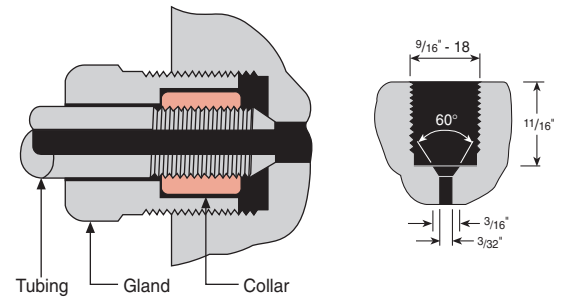

### 3/8" High Pressure

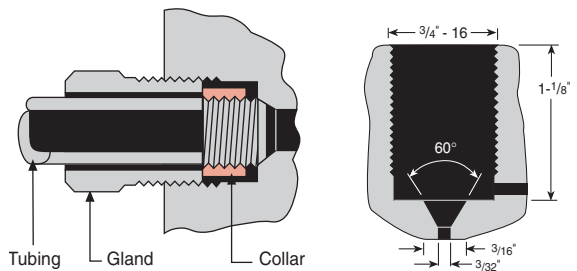



# High Pressure Gauges

## Stainless Steel Panel Mounted Pressure Gauges

Stainless steel, panel mounted pressure gauges are available from stock for immediate delivery. These gauges are standard with a High Pressure 1/4" O.D. tubing connection (HF4). These coned and threaded connections are machined directly into the bottom inlet of the gauges. Adapters for other size connections are available from stock.

HiP stainless steel gauges have a solid front separating the dial face from the pressure tube in order to provide maximum safety. Bourdon tube and socket are 316 S.S. and include a safety blowout back and laminated safety glass. Gauges may be used intermittently to 100 percent of dial reading.

Accuracy on 5,000 psi and 10,000 psi models is 1/2% of full scale reading. Accuracy on 20,000 psi through 30,000 psi models is 1% of full scale reading.



Gauge Size			Graduations			Materials	
Catalog No.	Range psi	Dial Size				Mounting	Case
4PG5	0-5,000	4"	500	100	50	Panel	316 S.S.
4PG10	0-10,000	4"	1,000	500	100		
6PG20	0-20,000	6"	2,000	1,000	200		
6PG30	0-30,000	6"	3,000	1,000	200		

## Dimensions

Dial Size	A	B	D	F
4" 4PG5, 4PG10	3/16"	4 35/64"	5 3/16"	3 7/8"
6" 6PG20, 6PG30	7/32"	7"	7 11/16"	6 1/4" - 6 5/16"

PANEL MOUNTING

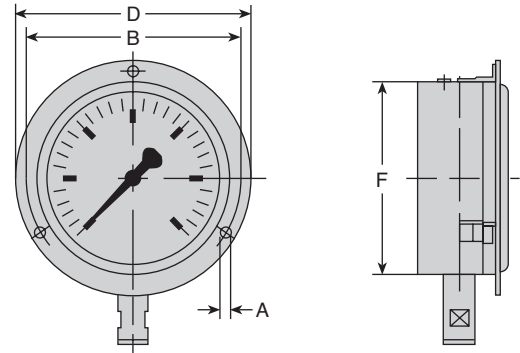

## Gauge Snubber

The gauge snubber is a device used to "smooth" out the pressure fluctuations created by reciprocating pumps commonly used to develop the high pressures required for waterjet cutting. This "smoothing" action provides more accurate pressure indication and extends the life and calibration of the pressure gauge. Gauge Snubber is rated for 60,000 psi service and uses a 1/4" HP connection (3/8" and 9/16" HP available).



## Rotaseal

The ROTASEAL was developed for use in the waterjet cutting industry where a rotating member is required to conduct the high pressure water safely and without leaks.

The ROTASEAL is offered in two configurations - right angle or straight through. ROTASEALS are available for pressures to 60,000 PSI and flow rates to 15 GPM (at lower pressures).







# High Pressure Equipment

---

## Tooling

To ensure safe and leak-free operation of your pressure system, High Pressure Equipment Company provides complete installation instructions for the make-up of a coned and threaded connection. In addition to outlining the correct procedures, we offer coning and threading tools and female tubing connection tools.



### Index

---

Reseating Tools .....	124
Coning Tools .....	125
Threading Tools .....	125
Coning & Threading Instructions .....	126

# Tooling

The coned and threaded tubing ends for the medium, high and ultra high pressure connections may be supplied by any of the following:

1. Standard length tubing nipples with ends prepared. Maintained in stock—ready for shipment.
2. Special length tubing nipples with ends prepared. Specify length required (up to 22 feet long). Add coning and threading charge to tubing price. (While not in stock, special length nipples can be furnished quickly for prompt delivery).
3. Preparation of tubing ends at your own facility by hand tooling as described in this section.

The coning and threading tools are designed for simple yet accurate preparation of tubing ends for the medium, high and ultra high pressure connections. A liberal amount of cutting fluid should be used, and a supply is furnished with each order for tooling. Interchangeable spare parts allow easy change over from one size tubing to another on both the coning and threading tools. Note that the reseating tool is not required for tubing preparation.

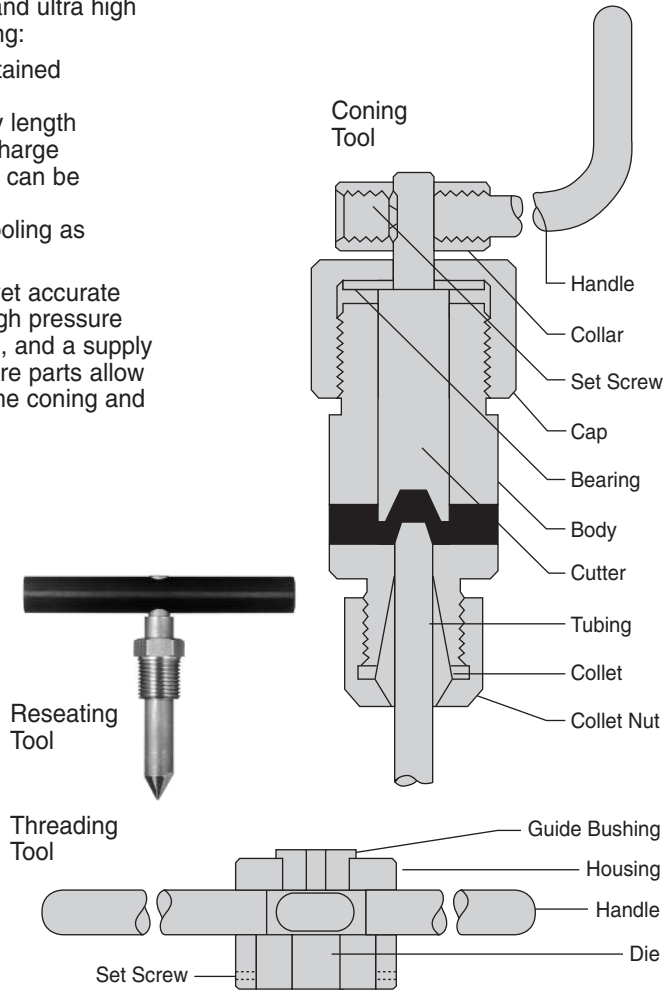
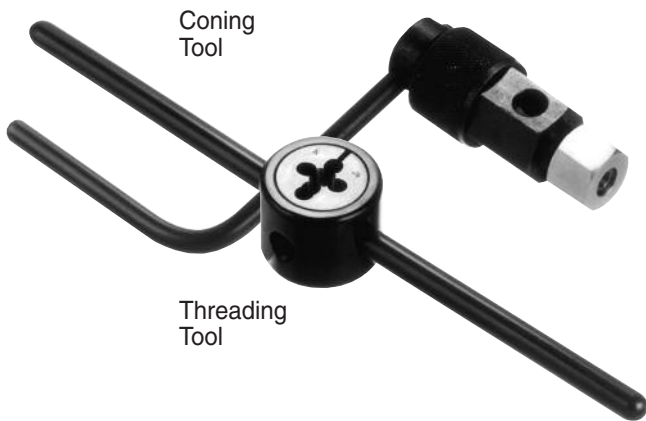

## Reseating Tools

The reseating tools are available for repairing old or damaged tubing connection seats in valves or fittings. This tool is not required for tubing preparation.

Catalog No.	For Tubing Connection
RTL4	LF4
RTL6	LF6
RTL9	LF9
RTHF2	HF2
RTHF4	HF4
RTHF6	HF6
RTHF9	HF9
RTXF4	XF4
RTXF6	XF6

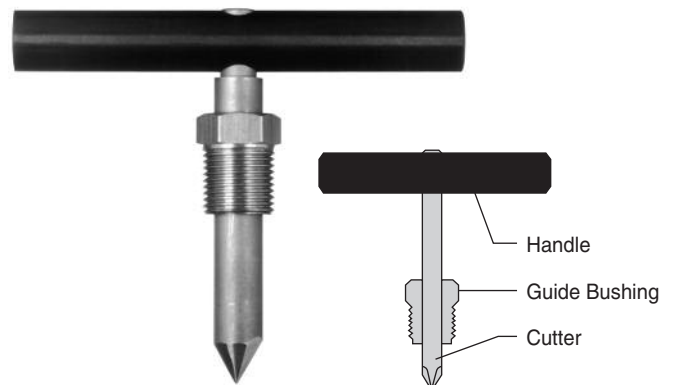

## Coning Tools

The coning tool is designed for preparing a “cone” on the ends of Medium, High and Ultra High Pressure tubing. Included angle of the cone is approximately 57 to 59 degrees. The cutter and collet are interchangeable on all of the assemblies (except 2-HF9 and 2-LF9) to permit changing from one size tubing to another.

Catalog No.	Tubing Size	Spare Cutter	Spare Collet
2-LF4	(1/4" O.D. x .109" I.D. (20,000 psi)	2-LF4L	2-LF4P
2-LF6	(3/8" O.D. x .203 I.D. (20,000 psi)	2-LF6L	2-LF6P
2-LF9	(9/16" O.D. x .312 I.D. (20,000 psi)	2-LF9L*	2-LF9P*
2-HF2	(1/8" O.D. x .020 I.D. (60,000 psi)	2-HF2L	2-HF2P
	(1/8" O.D. x .040 I.D. (30,000 psi)		
2-HF4	(1/4" O.D. x .083 I.D. (60,000 psi)	2-HF4L	2-HF4P
2-HF6	(3/8" O.D. x 1/8" I.D. (60,000 psi)	2-HF6L	2-HF6P
2-HF9	(9/16" O.D. x 3/16" I.D. x (60,000 psi)	2-HF9L*	2-HF9P*
2-XF4	(1/4" O.D. x 1/16" I.D. (100,000 psi)	2-XF4L	2-XF4P
2-XF6	(3/8" O.D. x 1/16" I.D. (150,000 psi)	2-XF6L	2-XF6P

\* Not interchangeable



For more information, watch our training video online [www.highpressure.com/C-Video](http://www.highpressure.com/C-Video)

## Threading Tools

The threading tool is designed for preparing a left-hand thread onto Medium, High and Ultra High Pressure tubing ends. The threaded die and guide bushings are interchangeable on all of the assemblies (except 2-MHF2) to permit changing from one size tubing to another. The guide bushing on the 2-MHF2 is built into the die holder.

Catalog No.	Tubing Size	Spare Threading Die	Spare Guide Bushing
2-MLF4	1/4" O.D.	1/4" - 28LH	2-MLF4P
2-MLF6	3/8" O.D.	3/8" - 24LH	2-MLF6P
2-MLF9	9/16" O.D.	9/16" - 18LH	2-MLF9P
2-MHF2	1/8" O.D.	1/8" - 40LH	N/A
2-MHF4	1/4" O.D.	1/4" - 28LH	2-MHF4P
2-MHF6	3/8" O.D.	3/8" - 24LH	2-MHF6P
2-MHF9	9/16" O.D.	9/16" - 18LH	2-MHF9P
2-MXF4	1/4" O.D.	1/4" - 28LH	2-MXF4P
2-MXF6	3/8" O.D.	3/8" - 24LH	2-MXF6P



# Tooling

## Coning Tubing Ends

The coning tool is designed for preparing a “cone” having an included angle of approximately 57 to 59 degrees on the ends of tubing.

Operation is as follows:

1. Secure coning tool body in suitable vise.  
You may wish to angle the tool in the vise in order to facilitate access to the collet nut and knurled cap.
2. Cut off tubing to desired length and deburr ends.
3. Rotate knurled cap clockwise into tool as far as it will go.
4. “Back off” knurled cap by rotating counterclockwise a number of complete rotations as indicated in the chart below. (A mark on the knurled cap may be useful).

Tubing Size	“Back Off Turns”
$\frac{1}{8}$ " O.D.	3 turns
$\frac{1}{4}$ " O.D.	4 $\frac{1}{2}$ turns
$\frac{3}{8}$ " O.D.	4 $\frac{1}{2}$ turns
$\frac{9}{16}$ " O.D.	8 turns

5. Insert tubing thru collet nut and collet until tubing stops up against inside cutter.
6. Tighten collet nut to secure tubing into position.
7. Turn knurled cap counterclockwise to remove cap and cutter from tool.
8. Apply a very liberal amount of “Sulflo” (sulphur based cutting compound) to the end of the cutter.
9. Screw cap and cutter back into the body until the cutter contacts the end of the tubing.
10. Rotate handle of cutting tool clockwise fairly rapidly with one hand while slowly rotating the knurled cap clockwise with the other hand in order to continuously feed the cutter into the tubing. Do not overly force the cutter against the tubing as it will bind. (You will quickly develop the proper feel). You will need to rotate the knurled cap a complete number of turns as per the chart below in order to complete the cone on the end of the tubing.

Tubing Size	“Back Off Turns”
$\frac{1}{8}$ " O.D.	2 $\frac{1}{2}$ turns
$\frac{1}{4}$ " O.D.	3 $\frac{1}{2}$ turns
$\frac{3}{8}$ " O.D.	4 turns
$\frac{9}{16}$ " O.D.	7 $\frac{1}{2}$ turns

11. After coning the tubing end, loosen the collet nut and remove tubing from the tool. Remove the knurled cap and cutter from the tool in order to clean off the Sulflo compound and steel chips in preparation for the next tube.

### NOTES:

- A. Steps 3 and 4 (on left) are primarily a help in properly positioning the tubing in the tool. As you gain experience with the tool, you will be able to judge the proper position by sight in order to eliminate these steps.
- B. The  $\frac{1}{4}$ " O.D. and  $\frac{3}{8}$ " O.D. tubing sizes are relatively easy to cone. The  $\frac{1}{8}$ " O.D. size is “delicate” (be especially careful not to force the cutter). The  $\frac{9}{16}$ " O.D. size requires the most amount of firmness in the cutting.
- C. As with other tools, it is not uncommon for a collet to “stick” even after the collet nut has been released. Should this occur, simply tap the side of the collet nut firmly with the wrench to release the collet.

## Threading the Tubing

The threading tool is designed to put a left hand thread onto the end of the tubing. Operation is as follows:

1. The coning tool (with the knurled cap and cutter removed) provides an ideal way to hold the tubing for the threading operation (see photo).
2. After securing the tubing, apply a liberal amount of Sulflo to the end of the tubing.
3. Place the threading tool (guide bushing side first) onto the tubing.
4. Place the palm of your hand firmly against the center of the threading tool and rotate your wrist counterclockwise. This will help “start” the die onto the tube. After you feel the die start onto the tubing, continue to rotate the threading tool using the handles.
5. Remove the threading tool and clean off Sulflo and chips.

### NOTE:

The tubing collar should easily screw onto the tubing. If it feels too tight or loose, the die should be adjusted accordingly. Simply remove the die from the holder by loosening the outer set screw. The small adjustment screw located on the side of the die can be turned to precisely set the die.





# High Pressure Equipment

---

## Pressure Vessels and Reactors

High Pressure Equipment Company designs and manufactures a broad range of pressure vessels and reactors for both bench-scale and pilot plant applications. We have over 250 standard reactor designs which address varied size, material, pressure and temperature requirements.

There are many applications that demand ASME approval for work involving pressure vessels. To satisfy this need, HiP produces a variety of pressure vessels and reactors that meet the requirements of the ASME Pressure Vessel Code.

Complementing our standard product offering is our capability to provide a custom reactor designed to meet your specific needs. Our engineering and technical support team will help you identify the specific options you need, ranging from exotic materials to unusual sizes and connections, and then incorporate the appropriate approvals, including ASME.









### Index

---

Pressure Vessel Selection . . .	128-129
O-Ring Seal Reactors	
Series OC . . . . .	130
Confined Gasket Closure Reactors	
Series GC . . . . .	131
Bolted Closure Reactors . . . . .	132
Clover Leaf Reactors . . . . .	133
O-Ring Closure Reactors	
Series R . . . . .	134-135
Tubular Reactors	
Series TOC . . . . .	136-137
Reactors	
Series MS . . . . .	138
Series MB . . . . .	138

# Pressure Vessels and Reactors

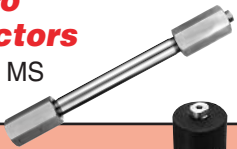
## Reactor Selection Guide

Reactor Design	Description	Standard Material	Maximum Temperature (degrees F)	Maximum Working Pressure (psi)	Standard Capacity
<b>O-ring Seal</b> Series OC 	Simple closure design allows for easy assembly/disassembly and reliable operation. Series OC are economical reactors ideal for low temperature gas or liquid service.	316SS	250	16,000	125 mL to 6,750 mL
<b>Confined Gasket Closure</b> Series GC 	Series GC is designed for studying high temperature and pressure reactions. The vessels utilize thrust bolts and a thrust ring to ensure positive seating of the gasket.	316SS	800	16,000	125 mL to 6,750 mL
<b>Bolted Closure</b> Series BC 	These versatile reactors are the standard of the industry for applications involving moderate pressure ranges. Standard O-rings may be used in place of the metal gasket for lower temperatures.	316SS	650	5,000	300 mL to 2 gal.
<b>Clover Leaf</b> Series CL 	Quick opening cover design needs only one-eighth of a turn rotation for sealing. Ideal for high pressure operations requiring repetitive opening/closing.	4340 alloy steel	250	30,000	1,000 mL to 3,700 mL
<b>O-ring Closure</b> Series R 	Designed for extremely high pressure/low temperature operation, series R reactors feature a threaded closure for easy assembly and disassembly.	4340 alloy steel	250	150,000	77 mL to 30 liters
<b>Micro Reactors</b> Series MS 	Series MS are fixed bed tubular reactors designed for a variety of applications such as small volume testing of components and miniature scale reaction tests.	316SS	800	30,000	2 mL to 64 mL
<b>Tubular Reactors</b> Series TOC 	This line of economical and versatile reactors satisfy many moderate pressure applications. Accumulators can be customized through a variety of options including piston separators.	304SS	O-ring 250 confined gasket 800	10,000	50 mL to 15 liters
<b>Custom Reactors</b>	HiP makes every reactor to order, allowing for economical and timely customizing. We offer a broad range of exotic metals, sizes and connections to meet virtually any requirement.	—	—	—	—

**Note:** For ASME code stamping of HiP vessels, please consult factory for available reactor designs, materials, and pressure ratings.





**Pressure Vessel Volume Table (cubic inches)**

Inside Depth (inches)	Inside Diameter (inches)												
	1/2"	1"	1 1/2"	2"	2 1/2"	3"	4"	5"	6"	7"	8"	9"	10"
4"	0.7856	3.142	7.068	12.57	19.63	28.27	50.26	78.54	113.1	153.9	201.1	254.5	314.2
6"	1.178	4.712	10.60	18.85	29.45	42.41	75.40	117.8	169.6	230.9	301.6	381.7	471.2
8"	1.571	6.283	14.14	25.13	39.27	56.55	100.5	157.1	226.2	307.9	402.1	508.9	628.4
10"	1.964	7.854	17.67	31.42	49.09	70.69	125.7	196.3	282.7	384.8	502.6	636.2	785.2
12"	2.357	9.425	21.21	37.70	58.90	84.82	150.8	235.6	339.3	461.8	603.2	763.4	942.4
14"	2.749	11.00	24.74	43.98	68.72	98.96	175.9	274.9	395.8	538.8	703.7	890.6	1100
16"	3.142	12.57	28.27	50.27	78.54	113.1	201.1	314.2	452.4	615.8	804.2	1018	1257
18"	3.535	14.14	31.81	56.55	88.36	127.2	226.2	353.4	508.9	692.7	904.8	1145	1415
20"	3.928	15.71	35.34	62.83	98.17	141.4	251.3	392.7	565.5	769.7	1005	1272	1571
22"	4.231	17.28	38.88	69.12	108.0	155.5	276.5	432.0	622.0	846.7	1106	1400	1728
24"	4.714	18.85	42.41	75.40	117.8	169.6	301.6	471.2	678.6	923.6	1206	1527	1885
26"	5.106	20.42	45.94	81.68	127.6	183.8	326.7	510.5	735.1	1001	1307	1654	2042
28"	5.499	21.99	49.48	87.96	137.4	197.9	351.8	549.8	791.7	1078	1407	1781	2199

**Volume Equivalents**

1 in<sup>3</sup> = 16.39 mL  
 1 mL = 0.061 in<sup>3</sup>  
 1 gal = 231 in<sup>3</sup> = 0.134 ft<sup>3</sup>  
 1 ft<sup>3</sup> = 1728 in<sup>3</sup> = 7.481 gal  
 1 L = 61.02 in<sup>3</sup> = 0.264 gal

**Pressure Conversions**

	psi	atm	kg/cm <sup>2</sup>
psi	1	0.068	0.070
atm	14.696	1	1.033
kg/cm <sup>2</sup>	14.224	0.968	1

# Pressure Vessels and Reactors

## OC Series O-Ring Seal Reactors

The OC Series provide a simple closure that is reliable and easy to assemble and disassemble. Standard material for the body and cover is Type 316 stainless steel. The standard O-ring material is BUNA-N. Temperature is limited by the O-ring to 250°F.

These reactors are suitable for either gas or liquid service. Capacities range from 125 mL to 6,750 mL.

Standard connections are for  $\frac{1}{4}$ " O.D. high pressure (coned and threaded) tubing (HF4). Models OC-1 and OC-3 have one connection in the cover. All other models have two connections in the cover. Contact factory if other connections and/or locations are preferred.

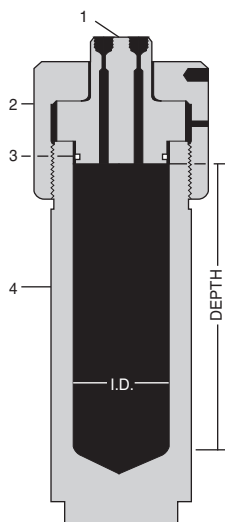

- 1. COVER 316 S.S.
- 2. CAP ALLOY STEEL
- 3. "O" RING BUNA-N
- 4. BODY 316 S.S.

### Series OC Reactors

Catalog No.	I.D.	O.D.	Inside Depth	Capacity	Material	Working Pressure psi
OC-1*	1"	2 $\frac{1}{2}$ "	10"	125 mL	316 S.S.	13,800
OC-3*	1 $\frac{1}{2}$ "	2 $\frac{1}{2}$ "	10"	280 mL	316 S.S.	7,750
OC-5	1 $\frac{1}{2}$ "	4 $\frac{3}{8}$ "	10"	280 mL	316 S.S.	16,000
OC-7	1 $\frac{1}{2}$ "	4 $\frac{3}{8}$ "	21"	600 mL	316 S.S.	16,000
OC-9	2"	4 $\frac{3}{8}$ "	10"	500 mL	316 S.S.	12,500
OC-11	2"	4 $\frac{3}{8}$ "	21"	1,040 mL	316 S.S.	12,500
OC-13	2 $\frac{1}{2}$ "	4 $\frac{3}{8}$ "	10"	800 mL	316 S.S.	9,200
OC-15	2 $\frac{1}{2}$ "	4 $\frac{3}{8}$ "	21"	1,160 mL	316 S.S.	9,200
OC-17	3"	6 $\frac{7}{8}$ "	10"	1,150 mL	316 S.S.	13,000
OC-19	3"	6 $\frac{7}{8}$ "	21"	2,430 mL	316 S.S.	13,000
OC-21	3 $\frac{1}{2}$ "	6 $\frac{7}{8}$ "	10"	1,575 mL	316 S.S.	10,500
OC-23	3 $\frac{1}{2}$ "	6 $\frac{7}{8}$ "	21"	3,300 mL	316 S.S.	10,500
OC-25	4"	6 $\frac{7}{8}$ "	10"	2,060 mL	316 S.S.	8,500
OC-27	4"	6 $\frac{7}{8}$ "	21"	4,325 mL	316 S.S.	8,500
OC-29	4 $\frac{1}{2}$ "	6 $\frac{7}{8}$ "	10"	2,600 mL	316 S.S.	6,500
OC-31	4 $\frac{1}{2}$ "	6 $\frac{7}{8}$ "	21"	5,475 mL	316 S.S.	6,500
OC-33	5"	6 $\frac{7}{8}$ "	10"	3,200 mL	316 S.S.	5,000
OC-35	5"	6 $\frac{7}{8}$ "	21"	6,750 mL	316 S.S.	5,000

\* One (1) opening only in cover

## Confined Gasket Closure Reactors

The Confined Gasket Closure reactors listed below are ideally suited for use at elevated temperatures and pressures as shown in the chart. Thrust bolts with a hardened thrust ring are supplied to insure positive seating of the gasket. Torque required on thrust bolts will range from 70 to 125 foot pounds, depending upon size of reactor, pressure, temperature and media being pressurized. Torquing of bolts should be done in a crisscross staggered pattern to insure uniform seating. A commercial high temperature lubricant should always be applied to the bolt threads and outside cap threads to facilitate removal of the closure.

Standard material for the body, cover and gasket is Type 316 stainless steel. These reactors are suitable for either gas or liquid service and capacities range from 125mL to 6,750 mL.

Standard connections supplied are for 1/4" O.D. high pressure (coned and threaded) tubing (HF4). Models GC-1 and GC-3 have one connection in the cover. All other models have two connections in the cover and a thermowell that extends two-thirds of the inside depth.

Included with each reactor are eye bolts for lifting and necessary collars and glands for the connections. Vise flats are machined on to the bottom of the body for securing while assembling or disassembling closure.



## Series GC Reactors

Catalog No.	I.D.	O.D.	Inside Depth	Capacity	Material	Working Pressure (psi)		
						100°F	650°F	800°F
GC-1	1"	2 1/2"	10"	125 mL	316 S.S.	13,800	12,500	12,000
GC-3	1 1/2"	2 1/2"	10"	280 mL	316 S.S.	7,750	7,000	6,900
GC-5	1 1/2"	4 3/8"	10"	280 mL	316 S.S.	16,000	14,500	14,000
GC-7	1 1/2"	4 3/8"	21"	600 mL	316 S.S.	16,000	14,500	14,000
GC-9	2"	4 3/8"	10"	500 mL	316 S.S.	12,500	11,400	11,000
GC-11	2"	4 3/8"	21"	1,040 mL	316 S.S.	12,500	11,400	11,000
GC-13	2 1/2"	4 3/8"	10"	800 mL	316 S.S.	9,200	8,400	8,200
GC-15	2 1/2"	4 3/8"	21"	1,160 mL	316 S.S.	9,200	8,400	8,200
GC-17	3"	6 7/8"	10"	1,150 mL	316 S.S.	13,000	11,000	10,000
GC-19	3"	6 7/8"	21"	2,430 mL	316 S.S.	13,000	11,000	10,000
GC-21	3 1/2"	6 7/8"	10"	1,575 mL	316 S.S.	10,500	9,000	8,000
GC-23	3 1/2"	6 7/8"	21"	3,300 mL	316 S.S.	10,500	9,000	8,000
GC-25	4"	6 7/8"	10"	2,060 mL	316 S.S.	8,500	7,300	6,500
GC-27	4"	6 7/8"	21"	4,325 mL	316 S.S.	8,500	7,300	6,500
GC-29	4 1/2"	6 7/8"	10"	2,600 mL	316 S.S.	6,500	5,500	5,000
GC-31	4 1/2"	6 7/8"	21"	5,475 mL	316 S.S.	6,500	5,500	5,000
GC-33	5"	6 7/8"	10"	3,200 mL	316 S.S.	5,000	4,300	4,000
GC-35	5"	6 7/8"	21"	6,750 mL	316 S.S.	5,000	4,300	4,000

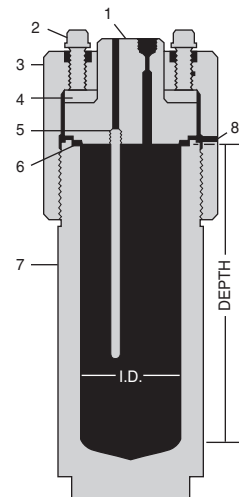

- 1. COVER
  - 2. SET SCREW
  - 3. CAP
  - 4. THRUST RING
  - 5. GASKET
  - 6. GASKET
  - 7. BODY
  - 8. WEEP HOLE
- 316 S.S.
  - COMM.
  - ALLOY ST'L
  - TOOL ST'L
  - COPPER
  - 316 S.S.
  - 316 S.S.

# Pressure Vessels and Reactors

## Bolted Closure Reactors

The Bolted Closure Reactors are designed for use up to 650°F (343°C) at the working pressures indicated. Standard material for the body, cover and gasket is Type 316 stainless steel. Standard O-rings may be used in place of the metal gasket when temperatures permit.

Standard connections include two high pressure (coned and threaded) tubing connections for 1/4" O.D. tubing (HF4) located in the cover. Contact factory if other connections and/or locations are preferred.

Other items available include:

- Heating mantle. Removable quartz fabric cylinder column type. 110 volt, single phase. Bolted closure reactors are supplied with mounting bolt holes on the bottom surface.
- Thermowell for use with 1/16" thermocouple
- Safety head located in side flange with rupture disc (see Page 35)



## Bolted Closure Reactors

Catalog No.	Capacity	Working Pressure psi	Temperature Rating °F	Inside Diameter	Inside Depth	Approx. Weight (pounds)	Approx. Torque (ft-lb) per Bolt	Material
BC-1	300 mL	5,000	650	2"	6"	21	40	316 S.S.
BC-2	1 liter	5,000	650	3"	9"	50	75	316 S.S.
BC-3	2 liter	5,000	650	3 1/2"	12 1/2"	68	105	316 S.S.
BC-4	1 gallon	3,000	650	5"	12"	97	105	316 S.S.
BC-5	1 gallon	5,000	650	5"	12"	152	175	316 S.S.
BC-6	2 gallon	3,000	650	6 1/2"	14"	245	140	316 S.S.

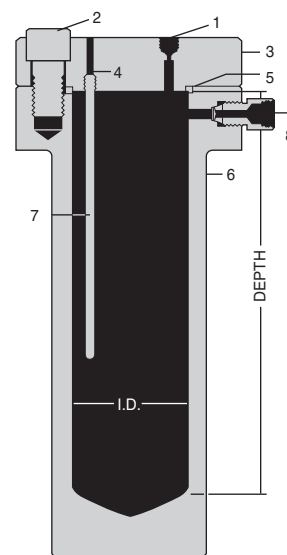

1. PRESSURE CONNECTION (2)
2. SOCKET CAP SCREW
3. COVER
4. GASKET
5. MAIN SEAL
6. BODY
7. THERMOCOUPLE WELL\*
8. SAFETY HEAD\*

\* SUPPLIED AS EXTRA WHEN SPECIFIED

## Pressure Ratings

### Bolted Closure Reactors (psi) at Elevated Temperatures

Temperature °F (°C)	BC-1	BC-2, BC-3, BC-5	BC-4, BC-6	Temperature °F (°C)	BC-1	BC-2, BC-3, BC-5	BC-4, BC-6
100 (38)	5600	5250	3150	700 (371)	4900	4900	2950
200 (93)	5600	5250	3150	750 (399)	4800	4800	2850
300 (149)	5500	5100	3100	800 (427)	4200	4200	2500
400 (204)	5400	5050	3050	850 (454)	3400	3400	2050
500 (260)	5350	5050	3050	900 (482)	2500	2500	1500
600 (316)	5100	5050	3050	950 (510)	1700	1700	1000
650 (343)	5000	5000	3000	1000 (538)	900	900	550

## Clover Leaf Reactors

The “Clover Leaf” Closure Reactors provide maximum ease for quick opening or closing of the cover. The cover is simply inserted into the body and then rotated one-eighth of a turn. A safety locking pin is provided to insure that the cover is properly positioned and locked.

Standard material of construction for these reactors is heat treated 4340 alloy steel. Standard connections include two high pressure (coned and threaded) 1/4" O.D. tubing connections (HF4).

Mounting holes are provided in the top and bottom of the body for securing or lifting.

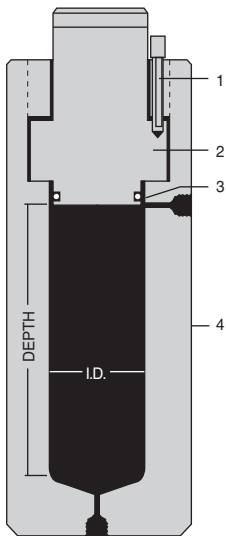

1. LOCK PIN
2. COVER
3. O-RING
4. BODY

### Clover Leaf Closure Reactors

Catalog No.	Inside Diameter	Outside Diameter	Inside Depth	Working Pressure psi	Temperature Rating °F	Capacity	Material
CL-1 CL-2 CL-3	3"	6 1/2"	9" 18" 22"	30,000	250	1,000 mL 2,000 mL 2,500 mL	Alloy Steel
CL-8 CL-9	4"	9 1/2"	9" 18"	30,000	250	1,850 mL 3,700 mL	Alloy Steel

# Pressure Vessels and Reactors

## Series "R" Reactors O-Ring Closure

The Series "R" O-ring Closure Reactors are easily assembled and disassembled with minimal torque required for complete engagement.

Material of construction for standard models is Type 4340 alloy steel (or equivalent) properly heat treated for use at elevated pressures. (Some models can be provided in stainless steel construction at reduced pressures — consult factory).

Sealing is accomplished by a highly reliable combination of O-ring and separate metal back-up ring. The wedge shaped back-up ring is designed to expand and contract as pressure increases or decreases. Consequently, the O-ring is continuously confined with no clearance for extrusion. Minimal initial torque is required to effect a positive seal.

Temperature on these vessels must be restricted to 250°F maximum, due to the BUNA-N (nitrile) O-ring. Included with each vessel is a Tony Bar for removal of the cover nut and necessary eye bolt holes for lifting of the body and components. Outer surfaces are blackened to prevent rusting.

Vent holes are provided to prevent pressure build up behind the closure in the event of a worn or damaged seal.

Connections include a top and bottom high pressure coned and threaded 1/4" O.D. (HF4) tubing connection. Other sizes or locations for connections can easily be provided when preferred. Consult factory.

Closures are designed in one-piece (cover) for vessels up to 2" I.D. and two-piece (cover and main nut) for vessels larger than 2" I.D.



One Piece Cover

Two Piece Cover

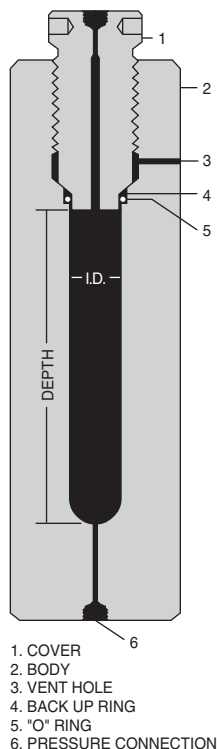

### O-Ring Closure Reactors (one piece cover)

I.D.	O.D.	Pressure Rating psi	Material	Inside Depth					
				6"	10"	12"	16"	20"	24"
1"	3 7/8"	30,000	4340 Alloy Steel or equivalent	R1-6-30	R1-10-30	R1-12-30	R1-16-30		
	3 1/2"	40,000		R1-6-40	R1-10-40	R1-12-40	R1-16-40		
	4 1/4"	60,000		R1-6-60	R1-10-60	R1-12-60	R1-16-60		
	5 1/2"	100,000		R1-6-100	R1-10-100	R1-12-100	R1-16-100		
	6 3/4"	150,000		R1-6-150	R1-10-150	R1-12-150	R1-16-150		
1 1/2"	3 5/8"	20,000	4340 Alloy Steel or equivalent	R1.5-6-20	R1.5-10-20	R1.5-12-20	R1.5-16-20		
	4 1/8"	30,000		R1.5-6-30	R1.5-10-30	R1.5-12-30	R1.5-16-30		
	4 3/4"	40,000		R1.5-6-40	R1.5-10-40	R1.5-12-40	R1.5-16-40		
	6 1/2"	60,000		R1.5-6-60	R1.5-10-60	R1.5-12-60	R1.5-16-60		
	8"	100,000		R1.5-6-100	R1.5-10-100	R1.5-12-100	R1.5-16-100		
10 1/2"	150,000	R1.5-6-150	R1.5-10-150	R1.5-12-150	R1.5-16-150				
2"	4 1/4"	20,000	4340 Alloy Steel or equivalent	R2-6-20	R2-10-20	R2-12-20	R2-16-20	R2-20-20	R2-24-20
	5"	30,000		R2-6-30	R2-10-30	R2-12-30	R2-16-30	R2-20-30	R2-24-30
	6 1/2"	40,000		R2-6-40	R2-10-40	R2-12-40	R2-16-40	R2-20-40	R2-24-40
	8 1/2"	60,000		R2-6-60	R2-10-60	R2-12-60	R2-16-60	R2-20-60	R2-24-60
	12"	100,000		R2-6-100	R2-10-100	R2-12-100	R2-16-100	R2-20-100	R2-24-100



**O-Ring Closure Reactors (two piece cover)**

I.D.	O.D.	Pressure Rating psi	Material	Inside Depth					
				6"	10"	12"	16"	20"	24"
3"	6"	20,000	4340 Alloy Steel or equivalent	R3-6-20	R3-10-20	R3-12-20	R3-16-20	R3-20-20	R3-24-20
	7"	30,000		R3-6-30	R3-10-30	R3-12-30	R3-16-30	R3-20-30	R3-24-30
	8 1/2"	40,000		R3-6-40	R3-10-40	R3-12-40	R3-16-40	R3-20-40	R3-24-40
	11 1/2"	60,000		R3-6-60	R3-10-60	R3-12-60	R3-16-60	R3-20-60	R3-24-60
	15"	100,000		R3-6-100	R3-10-100	R3-12-100	R3-16-100	R3-20-100	R3-24-100
4"	8"	20,000		R4-6-20	R4-10-20	R4-12-20	R4-16-20	R4-20-20	R4-24-20
	9 1/4"	30,000		R4-6-30	R4-10-30	R4-12-30	R4-16-30	R4-20-30	R4-24-30
	11"	40,000		R4-6-40	R4-10-40	R4-12-40	R4-16-40	R4-20-40	R4-24-40
	13"	50,000		R4-6-50	R4-10-50	R4-12-50	R4-16-50	R4-20-50	R4-24-50
	15"	60,000		R4-6-60	R4-10-60	R4-12-60	R4-16-60	R4-20-60	R4-24-60
5"	9 1/4"	20,000		R5-6-20	R5-10-20	R5-12-20	R5-16-20	R5-20-20	R5-24-20
	11 1/4"	30,000		R5-6-30	R5-10-30	R5-12-30	R5-16-30	R5-20-30	R5-24-30
	13 1/4"	40,000		R5-6-40	R5-10-40	R5-12-40	R5-16-40	R5-20-40	R5-24-40
	15 1/4"	50,000		R5-6-50	R5-10-50	R5-12-50	R5-16-50	R5-20-50	R5-24-50
	6"	9 1/2"		10,000	R6-6-10	R6-10-10	R6-12-10	R6-16-10	R6-20-10
11 1/2"		20,000		R6-6-20	R6-10-20	R6-12-20	R6-16-20	R6-20-20	R6-24-20
13 3/4"		30,000		R6-6-30	R6-10-30	R6-12-30	R6-16-30	R6-20-30	R6-24-30
15"		40,000		R6-6-40	R6-10-40	R6-12-40	R6-16-40	R6-20-40	R6-24-40
7"		10 3/4"		10,000	R7-6-10	R7-10-10	R7-12-10	R7-16-10	R7-20-10
	13"	20,000		R7-6-20	R7-10-20	R7-12-20	R7-16-20	R7-20-20	
	15 1/4"	30,000	R7-6-30	R7-10-30	R7-12-30	R7-16-30	R7-20-30		
8"	12 1/2"	10,000	R8-6-10	R8-10-10	R8-12-10	R8-16-10	R8-20-10		
	14 1/4"	20,000	R8-6-20	R8-10-20	R8-12-20	R8-16-20	R8-20-20		
9"	13"	10,000	R9-6-10	R9-10-10	R9-12-10	R9-16-10	R9-20-10		
10"	14 3/4"	10,000	R10-6-10	R10-10-10	R10-12-10	R10-16-10	R10-20-10		

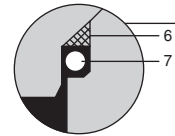
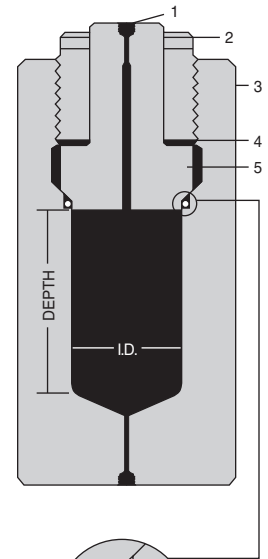

SEALING DETAIL

- 1. PRESSURE CONNECTION
- 2. MAIN UNIT NUT
- 3. BODY
- 4. VENT HOLE
- 5. COVER
- 6. BACK UP RING
- 7. "O" RING

# Pressure Vessels and Reactors

---

## Tubular Series Reactors

The Tubular Series Reactors are double ended pressure vessels made from commercial quality cold drawn Type 304 stainless steel seamless tubing. Outside (non-wetted) caps are alloy steel. These are both economical and versatile vessels proven in demand for many applications. Finishes are commercial cold drawn finishes, with honed internal finishes.

Standard sizes are shown in the chart on page 137, but special lengths and modifications are easily supplied on request. One pressure connection for  $\frac{1}{4}$ " O.D. high pressure coned and threaded tubing at each end is standard. Additional end connections are possible on the larger size models. Also, side connections and end cover thermowells can be supplied when required. Consult factory for special requirements.

O-Ring Closures are standard when temperatures do not exceed 250°F. This is an easily assembled closure requiring minimal torque for positive sealing. The standard O-ring material used is BUNA-N (nitrile) with various other O-ring materials available on request.

Confined Gasket Closures are available for temperatures up to 800°F. A 15% reduction in the listed working pressure is required at this elevated temperature level. These closures utilize a metal gasket (316 stainless steel) which can be torqued down for positive sealing. Torque requirements on the thrust bolts will range from 60 to 110 foot pounds depending on size, pressure, temperature and media being pressurized. These confined gasket closures are available for all models except the TOC1 and TOC3 series. When ordering, simply specify catalog number and add suffix "(W/Gasket)".

Piston Separators can be supplied with the O-ring closure vessels for use as compression cylinders. These are ideal for separating a liquid from a gas and other similar applications. The tubing body is supplied with a honed inside diameter surface to accommodate the piston. When ordering, simply specify catalog number and add suffix "(W/Piston)".



## Tubular Series Reactors

Tubing Size		Pressure Rating psi	Material	Catalog Number (O-Ring Closure)			
I.D.	O.D.			20"IL	40"IL	60"IL	72"IL
1"	1½"	5,000	Body 304 S.S.  Covers 316 S.S.	TOC1-20	TOC1-40	TOC1-60	TOC1-72
¾"	1½"	10,000		TOC3-20	TOC3-40	TOC3-60	TOC3-72
1¼"	2"	6,000		TOC5-20	TOC5-40	TOC5-60	TOC5-72
1"	2"	10,000		TOC7-20	TOC7-40	TOC7-60	TOC7-72
1¾"	2½"	4,000		TOC9-20	TOC9-40	TOC9-60	TOC9-72
1½"	2½"	7,000		TOC11-20	TOC11-40	TOC11-60	TOC11-72
2¼"	3"	3,000		TOC13-20	TOC13-40	TOC13-60	TOC13-72
2"	3"	5,000		TOC15-20	TOC15-40	TOC15-60	TOC15-72
2¾"	3½"	3,000		TOC17-20	TOC17-40	TOC17-60	TOC17-72
2½"	3½"	4,500		TOC19-20	TOC19-40	TOC19-60	TOC19-72
3¼"	4"	2,500		TOC21-20	TOC21-40	TOC21-60	TOC21-72
3"	4"	4,000		TOC23-20	TOC23-40	TOC23-60	TOC23-72
3½"	4½"	3,000		TOC25-20	TOC25-40	TOC25-60	TOC25-72
3"	4½"	5,000		TOC27-20	TOC27-40	TOC27-60	TOC27-72
4"	5"	3,000		TOC29-20	TOC29-40	TOC29-60	TOC29-72
3½"	5"	5,000		TOC31-20	TOC31-40	TOC31-60	TOC31-72

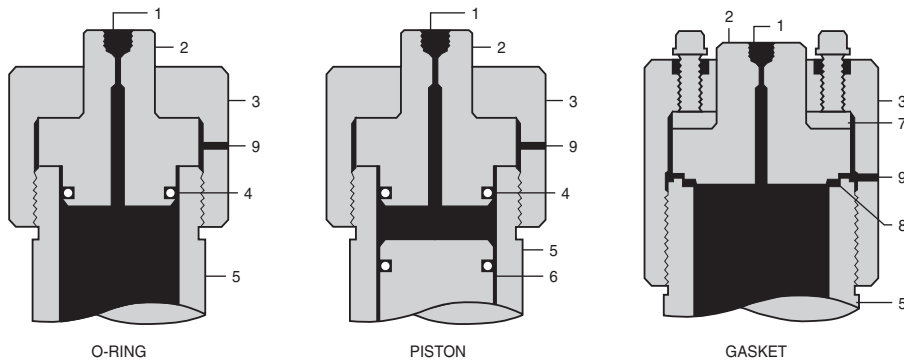
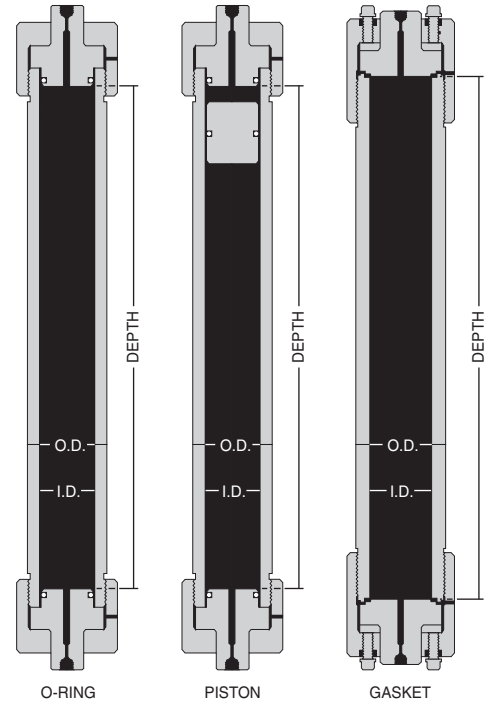

1. PRESSURE CONNECTION
2. COVER
3. CAP
4. "O" RING
5. BODY (BOTH ENDS ALIKE)
6. PISTON
7. THRUST RING
8. GASKET
9. WEEP HOLE

## How To Order Tubular Series Reactors

### With O-Ring Closure:

Specify catalog number, see ordering table above.

Note: Use of Buna-N O-ring limits maximum working temperature to 250°F. For higher temperatures to 800°F, order gasket closure.

### With Piston Separators:

Specify catalog number, see ordering table above and add "(W/Piston)" as suffix.

Because of temperature limitations pistons are not normally ordered in combination with the gasket closure.

### With Gasket Closure:

Specify catalog number, see ordering table above and add "(W/Gasket)" as suffix.  
\* Gasket closure is not available on 1½" O.D. tubing size vessels.

Example:  
TOC15-20 (W/Gasket).

# Pressure Vessels and Reactors

## Series "MS" Micro Reactors

The Micro Reactors shown are designed for numerous applications including small volume testing of components and miniature scale reaction tests.

Standard material of construction is Type 316 stainless steel.

Operation at temperatures up to 800°F is made possible by the metal to metal seal construction. Working pressures should be reduced by approximately 15% at the maximum 800°F temperature level.

Connections are for 1/4" O.D. high pressure coned and threaded tubing (HF4). One connection is provided at each end. Other sizes or types of connections can be provided. Thermocouples can easily be installed with the use of thermocouple adapters (refer to section 12).

Catalog No.	Capacity	Working Pressure psi	(C) Inside Diameter	(D) Outside Diameter	(A) Inside Depth	(B) Overall Length
MS-1	2 mL	60,000	3/16"	9/16"	4"	7"
MS-2	3 mL				6"	9"
MS-3	4 mL				8"	11"
MS-4	5 mL				10"	13"
MS-5	6 mL				12"	15"
MS-11	5 mL	20,000	5/16"	9/16"	4"	6 1/2"
MS-12	7 1/2 mL				6"	8 1/2"
MS-13	10 mL				8"	10 1/2"
MS-14	12 1/2 mL				10"	12 1/2"
MS-15	15 mL				12"	14 1/2"
MS-16	24 mL	20,000	9/16"	1"	6"	9"
MS-17	41 mL				10"	13"
MS-18	65 mL				16"	19"
MS-19	81 mL				20"	23"

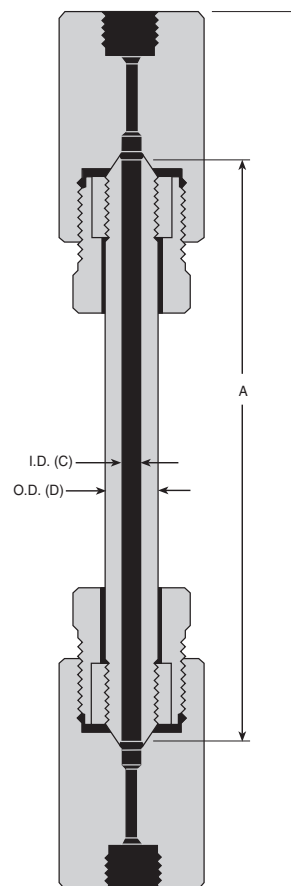

## Series "MB" Reactors

High Pressure Equipment Company's MB series reactors are designed for high pressure applications in which metal seals are required because of chemical or high temperature requirements.

The MB seal is a refinement of the Bridgeman seal, which operates on the unsupported area principle. When properly assembled, the pressure end load on the cover forces the entire closure assembly together, affecting the seal. The higher the pressure, the higher the sealing force.

MB Reactors are built to order and as such various volumes, pressure ratings and materials of construction can be used. Please consult factory for all options.

Note: No rotation should be permitted between the body and the seal ring, and between the seal ring and the cover. Relative rotation between these surfaces might result in galling and consequent seal failure.

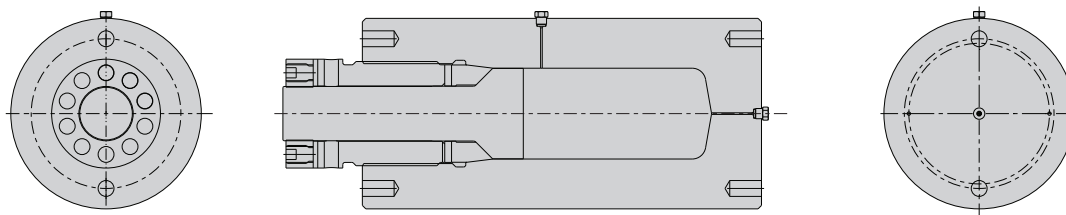



# High Pressure Equipment

## Technical Information

Selecting the right product to plumb your pressure system or conduct your research project is a critical decision. In this section, High Pressure Equipment Company provides a variety of technical information to assist you in this selection process. We have included a number of English to Metric conversion charts, flow coefficient formulas and valve ratings, reactor pressure ratings, and recommended torque values for our air operated valves and tubing connections.

As you work with this data, it is important to consider that it is general in nature and may vary depending on the actual parameters of your application. If you have any questions concerning this information or would like assistance in selecting an HiP product, our engineering staff is available and ready to help.



### Index

---

Conversion Tables .....	140
Flow Coefficients .....	141
Recommended Torque .....	142
Minimum Safety Hold Down Nut Torque .....	142
Minimum Bend Radius For High Pressure Tubing .....	142
Maximum Recommended Volumetric Flow Rate .....	143
Pressure Rating Reduction 316-304 SS Components at Elevated Temperatures .....	143
Pressure Ratings For: • Equipment in Various Common Materials .....	144
• Tubing in Various Materials .....	145
Graphs • Temperature Rating For Taper Seal Valves & Fittings .....	145
• Pressure Rating Reduction 316-304 SS Components at Elevated Temperatures .....	145

# Technical Information

## Conversion Tables

### Pressure

	Pa	kPa	psi	kg/cm <sup>2</sup>	bar	atm	MPa
Pa	1	0.001	1.450 x 10 <sup>-4</sup>	1.020 x 10 <sup>-5</sup>	1 x 10 <sup>-5</sup>	9.869 x 10 <sup>-6</sup>	1 x 10 <sup>-6</sup>
kPa	1000	1	0.145	0.01	0.01	0.01	0.001
psi	6.895 x 10 <sup>3</sup>	6.895	1	0.07	0.069	0.068	0.007
kg/cm <sup>2</sup>	9.807 x 10 <sup>4</sup>	98.07	14.22	1	0.981	0.968	0.098
bar	1 x 10 <sup>5</sup>	100	14.50	1.02	1	0.987	0.1
atm	101.3 x 10 <sup>5</sup>	101.3	14.7	1.033	1.013	1	0.101
MPa	1 x 10 <sup>6</sup>	1000	145	10.2	10	9.869	1

### Flow

	mL/min	in <sup>3</sup> /min	ft <sup>3</sup> /hr	liter/min	gal/min
mL/min	1	0.061	0.002	0.001	6.242 x 10 <sup>-4</sup>
in <sup>3</sup> /min	16.39	1	0.035	0.016	0.004
ft <sup>3</sup> /hr	472	28.8	1	0.472	0.125
liter/min	1000	61.02	2.119	1	0.264
gal/min	3785	231	8.021	3.785	1

### Weight/Mass

	gram	oz	lb	kg
gram	1	0.035	0.002	0.001
oz	28.35	1	0.063	0.028
lb	453.6	16	1	0.454
kg	1000	35.28	2.205	1

### Volume

	mL	in <sup>3</sup>	liter	gal	ft <sup>3</sup>	m <sup>3</sup>
mL	1	0.061	0.001	2.642 x 10 <sup>-4</sup>	3.531 x 10 <sup>-5</sup>	1 x 10 <sup>6</sup>
in <sup>3</sup>	16.39	1	0.016	0.004	5.787 x 10 <sup>-4</sup>	1.639 x 10 <sup>5</sup>
liter	1000	61.02	1	0.264	0.035	0.001
gal	3.785 x 10 <sup>3</sup>	231	3.785	1	0.134	0.004
ft <sup>3</sup>	2.832 x 10 <sup>4</sup>	1.728 x 10 <sup>3</sup>	28.32	7.481	1	0.028
m <sup>3</sup>	1 x 10 <sup>6</sup>	6.102 x 10 <sup>4</sup>	1000	264.2	35.32	1

### Linear

	micron	millimeter	centimeter	inch	foot	meter
micron	1	0.001	1 x 10 <sup>-4</sup>	3.937 x 10 <sup>-5</sup>	3.281 x 10 <sup>-6</sup>	1 x 10 <sup>-10</sup>
millimeter	1000	1	0.1	0.03937	0.003	0.001
centimeter	1 x 10 <sup>-4</sup>	10	1	0.394	0.033	0.01
inch	2.540 x 10 <sup>4</sup>	25.4	2.54	1	0.083	0.025
foot	3.048 x 10 <sup>5</sup>	304.8	30.48	12	1	0.305
meter	1 x 10 <sup>6</sup>	1000	100	39.37	3.281	1



## Flow Coefficients

The flow coefficient Cv is a valve sizing designation commonly determined by laboratory test. It corresponds to the flow rate of water through a valve in US gallons per minute at 60°F with a differential pressure drop of one psi.

### Flow coefficients of various HiP valves

Valve	Cv	Valve	Cv
15-11AF1	0.03	15-12AF1	0.045
15-11AF2	0.05	15-12AF2	0.075
10-11AF4	0.15	10-12AF4	0.225
10-11AF6	0.15	10-12AF6	0.225
20-11LF4	0.17	20-12LF4	0.255
20-11LF6	0.45	20-12LF6	0.675
20-11LF9	1.12	20-12LF9	1.68
10-11LF12	3.65	10-12LF12	5.475
20-11LF12	2.29	20-12LF12	3.435
10-11LF16	5.91	10-12LF16	8.865
20-11LF16	3.86	20-12LF16	5.79
30-11HF2	0.04	30-12HF2	0.06
30-11HF4	0.09	30-12HF4	0.135
30-11HF6	0.15	30-12HF6	0.225
30-11HF9	0.15	30-12HF9	0.225
30-11HF16	2.29	30-12HF16	3.435
40-11HF9	0.15	40-12HF9	0.225
60-11HF2	0.04	60-12HF2	0.06
60-11HF4	0.04	60-12HF4	0.06
60-11HF6	0.04	60-12HF6	0.06
60-11HF9	0.04	60-12HF9	0.06
100-11XF4	0.04	100-12XF4	0.06
150-11XF6	0.04	150-12XF6	0.06
10-11NFA	0.15	10-12NFA	0.225
10-11NFB	0.15	10-12NFA	0.225
10-11NFC	0.15	10-12NFC	0.225
10-11NFD	1.12	10-12NFD	0.18
15F-11NFA	0.45	15F-12NFA	0.675
15F-11NFB	0.45	15F-12NFB	0.675
15F-11NFC	1.12	15F-12NFC	1.68
15F-11NFD	1.12	15F-12NFD	1.68
10F-11NFF	5.91	10F-12NFF	8.865
10F-11NFH	5.91	10F-12NFH	8.865

With the Cv coefficient known, the following values can be calculated:

1. Liquid flow capacity in US gallons per minute

$$Q_l = C_v \cdot \sqrt{\frac{P}{G}}$$

2. Pressure drop across valve (liquid flow)

$$P = G \cdot \frac{Q_l^2}{C_v^2}$$

3. Gas flow capacity in standard cubic feet per hour (SCFH)

$$Q_g = 1360 \cdot C_v \cdot \sqrt{\frac{P \cdot P}{T \cdot G \cdot Z}}$$

4. Pressure drop across valve (gas flow)

$$P = \frac{T \cdot G \cdot Z}{P} \cdot \left( \frac{Q_g}{1360 \cdot C_v} \right)^2$$

Where:

$C_v$  = Valve flow coefficient

$G$  = Specific gravity of fluid

$P$  = Differential pressure drop across valve (psi)

$P$  = System pressure at valve inlet (psia)

$Q_l$  = Liquid flow in US gallons per minute (GPM)

$Q_g$  = Gas flow in standard cubic feet per hour (SCFH)

$T$  = System temperature (°R)

$Z$  = Gas compressibility factor at operating conditions

# Technical Information

## Recommended Torque

### Tubing Connections

Connection	Recommended Torque
AF1	55 inch pounds
AF2	10 foot pounds initial to compress sleeve onto tube 25 foot pounds to tighten connection
AF4	30 foot pounds initial to compress sleeve onto tube 50 foot pounds to tighten connection
AF6	40 foot pounds initial to compress sleeve onto tube 60 foot pounds to tighten connection
LF4	20 foot pounds
LF6	30 foot pounds
LF9	50 foot pounds
LF12	90 foot pounds
LF16	125 foot pounds
LF24	200 foot pounds
HF2	75 inch pounds
HF4	25 foot pounds
HF6	50 foot pounds
HF9	110 foot pounds
HF16	150 foot pounds
XF4	45 foot pounds
XF6	70 foot pounds

### Minimum Packing Gland Torque for Valves

Valve Series	Pressure Rating	Packing Gland Torque
15- <b>**</b> AF1 15- <b>**</b> AF2	15,000 psi	15 foot pounds
10- <b>**</b> AF4 10- <b>**</b> AF6	10,000 psi	30 foot pounds
10- <b>**</b> NFA 10- <b>**</b> NFB 10- <b>**</b> NFC	10,000 psi	35 foot pounds
10- <b>**</b> NFD	10,000 psi	50 foot pounds
20- <b>**</b> LF4 20- <b>**</b> LF6	20,000 psi 20,000 psi	35 foot pounds
20- <b>**</b> LF9	20,000 psi	70 foot pounds
30- <b>**</b> HF2 30- <b>**</b> HF4 30- <b>**</b> HF6 30- <b>**</b> HF9	30,000 psi	30 foot pounds
60- <b>**</b> HF2 60- <b>**</b> HF4 60- <b>**</b> HF6 60- <b>**</b> HF9	60,000 psi	40 foot pounds
100- <b>**</b> XF4	100,000 psi	60 foot pounds
150- <b>**</b> XF6	150,000 psi	90 foot pounds

### Minimum Safety Head Hold Down Nut Torque

Pressure psi	Torque foot pounds
10,000	40
15,000	45
20,000	50
25,000	55
30,000	60
35,000	65
40,000	70
45,000	75
50,000	80
55,000	85
60,000	90

### Minimum Recommended Bend Radius For High Pressure Tubing

Tube Size O.D. x I.D.	Minimum Bend Radius
0.250 x 0.062 0.250 x 0.083 0.250 x 0.109 0.250 x 0.125	1.25 in
0.375 x 0.062 0.375 x 0.125 0.375 x 0.203 0.375 x 0.250	1.75 in
0.562 x 0.188 0.562 x 0.250 0.562 x 0.312	2.62 in
0.750 x 0.438 0.750 x 0.516	3.50 in
1" x 0.438 1" x 0.562 1" x 0.688	4.62 in

# Technical Information

## Volumetric Flow Rate

### Maximum Recommended Volumetric Flow Rate for Water through a Tube

Orifice Size (inches)	Max Flow (gpm)	Approximate $\Delta P$ (psi/ft)
0.016	0.030	525
0.020	0.050	390
0.030	0.112	230
0.031	0.119	220
0.040	0.198	160
0.047	0.274	130
0.052	0.335	115
0.060	0.446	95
0.062	0.476	90
0.078	0.754	70
0.083	0.854	65
0.094	1.09	55
0.109	1.47	45
0.125	1.93	40
0.141	2.46	35
0.156	3.01	30
0.172	3.66	25
0.188	4.38	23
0.203	5.10	21
0.219	5.94	20
0.234	6.78	18
0.250	7.74	17
0.266	8.77	15
0.281	9.78	14
0.294	10.7	13
0.312	12.0	13
0.328	13.3	12
0.344	14.6	11
0.359	15.9	11
0.375	17.4	10
0.391	18.9	<10
0.406	20.4	<10
0.422	22.0	<10
0.438	23.7	<10
0.453	25.4	<10

Orifice Size (inches)	Max Flow (gpm)	Approximate $\Delta P$ (psi/ft)
0.469	27.2	<10
0.484	29.0	<10
0.500	30.9	<7
0.516	33.0	<7
0.531	34.9	<7
0.547	37.0	<7
0.562	39.1	<7
0.578	41.4	<7
0.594	43.7	<7
0.609	45.9	<7
0.625	48.4	<7
0.641	50.9	<7
0.656	53.3	<7
0.672	55.9	<5
0.688	58.6	<5
0.703	61.2	<5
0.719	64.0	<5
0.734	66.7	<5
0.750	69.7	<5
0.766	72.7	<5
0.781	75.6	<5
0.797	78.7	<5
0.812	81.7	<5
0.828	84.9	<5
0.844	88.3	<5
0.859	91.4	<5
0.875	94.9	<5
0.891	98.4	<5
0.906	101	<5
0.922	105	<5
0.938	109	<5
0.953	112	<5
0.969	116	<5
0.984	120	<5
1.000	123	<5

## Pressure Rating Reduction

316 and 304 SS components at elevated levels.

Temperature °F (°C)	Percent of Room Temperature Rating
Up to 100 (38)	100
200 (93)	100
300 (149)	100
400 (204)	96.5
500 (260)	90
600 (316)	85

Temperature °F (°C)	Percent of Room Temperature Rating
650 (343)	83
700 (371)	81.5
750 (399)	80.5
800 (427)	79.5
850 (453)	78.5

Intermediate values may be linearly interpolated.

## Pressure Ratings

### Equipment in Various Common Materials

Material	Connection	316 CNDS	316 CNDA	NIT50 CNDA	22% Chrome Duplex	25% Chrome Duplex	HC276	IN600
Pressure Rating at Room Temperature (psi)	AF1	15000	10000	15000	15000	15000	15000	10000
	AF2	15000	10000	15000	15000	15000	15000	10000
	AF4	10000	10000	10000	10000	10000	10000	10000
	AF6	10000	10000	10000	10000	10000	10000	10000
	LF12	10000	7500	10000	10000	10000	10000	10000
	LF16	10000	7500	10000	10000	10000	10000	10000
	LF4	20000	10000	14500	17000	20000	12500	9000
	LF6	20000	10000	14500	17000	20000	12500	9000
	LF9	20000	9000	17000	20000	20000	12500	10500
	LF12	20000	9000	17000	20000	20000	12500	10500
	LF16	20000	9000	17000	20000	20000	12500	10500
	LF24*	20000	8000	15000	15000	15000	12500	10500
	HF2	30000	20000	30000	30000	30000	29500	25000
	HF4	30000	20000	30000	30000	30000	29500	25000
	HF6	30000	20000	30000	30000	30000	29500	25000
	HF9	30000	20000	30000	30000	30000	29500	25000
	HF16	30000	14000	25500	30000	30000	19000	16000
	HF9	40000	20000	33000	34500	40000	24500	21000
	HF2	60000	30000	50000	52000	60000	37000	31500
	HF4	60000	30000	50000	52000	60000	37000	31500
	HF6	60000	30000	50000	52000	60000	37000	31500
	HF9	60000	30000	50000	52000	60000	37000	31500
	NFA	15000	8000	14500	15000	13000	10500	9000
	NFB	15000	8000	14500	15000	13000	10500	9000
NFC	15000	8000	14500	15000	13000	10500	9000	
NFD	15000	8000	14500	15000	13000	10500	9000	
NFF	10000	6500	10000	10000	10000	9000	7500	
NFH	10000	6500	10000	10000	10000	9000	7500	

Material	Connection	IN625 Grade 1	IN718	IN825	MO400	Ti2	Ti5	254 Smo
Pressure Rating at Room Temperature (psi)	AF1	15000	15000	15000	10000	15000	15000	15000
	AF2	15000	15000	15000	10000	15000	15000	15000
	AF4	10000	10000	10000	10000	10000	10000	10000
	AF6	10000	10000	10000	10000	10000	10000	10000
	LF12	10000	10000	10000	8000	10000	10000	10000
	LF16	10000	10000	10000	8000	10000	10000	10000
	LF4	15500	20000	9000	6500	10500	20000	11500
	LF6	15500	20000	9000	6500	10500	20000	11500
	LF9	18500	20000	10500	7500	12000	20000	13500
	LF12	18500	20000	10500	7500	12000	20000	13500
	LF16	18500	20000	10500	7500	12000	20000	13500
	LF24*	15000	15000	10500	7500	12500	15000	13500
	HF2	30000	30000	25000	17500	28500	30000	30000
	HF4	30000	30000	25000	17500	28500	30000	30000
	HF6	30000	30000	25000	17500	28500	30000	30000
	HF9	30000	30000	30000	17500	28500	30000	30000
	HF16	28000	30000	16000	11500	18500	30000	20500
	HF9	34500	40000	21000	15000	24000	40000	26500
	HF2	52000	60000	31500	22500	36500	60000	40000
	HF4	52000	60000	31500	22500	36500	60000	40000
	HF6	52000	60000	31500	22500	36500	60000	40000
	HF9	52000	60000	31500	22500	36500	60000	40000
	NFA	15000	15000	9000	6500	10500	15000	11500
	NFB	15000	15000	9000	6500	10500	15000	11500
NFC	15000	15000	9000	6500	10500	15000	11500	
NFD	15000	15000	9000	6500	10500	15000	11500	
NFF	10000	10000	7500	5000	8500	10000	9500	
NFH	10000	10000	7500	5000	8500	10000	9500	

\*Note: Fittings with LF24 connections are available in 316 CW material. Standard material for valves with LF24 connections is 2205 Duplex Stainless

## Pressure Ratings

### Tubing in Various Materials\*

	Part Number	Tubing Size OD x ID (inches)	Material vs Pressure Rating (psi)								
			316 CNDS	316 CNDA	22% Chrome Duplex	25% Chrome Duplex	Hastelloy C276	Inconel 600	Inconel 625 Gr 1	Monel 400	Titanium Gr 2
Low Pressure	15-9A2	1/8 x 0.060	15000	10000	15000	15000	15000	15000	15000	10000	15000
	10-9A4	1/4 x 0.125	10000	7500	10000	10000	10000	9000	10000	6500	9000
	10-9A6	3/8 x 0.250	10000	7500	10000	10000	10000	9000	10000	6500	9000
Medium Pressure	20-9M4	1/4 x 0.109	20000	10000	17500	20000	15000	11500	17500	8000	13000
	20-9M6	3/8 x 0.203	20000	10000	17500	20000	15000	11500	17500	8000	13000
	10-9M9	9/16 x 0.359	15000	7000	13000	15000	10000	8000	15000	6000	9500
	20-9M9	9/16 x 0.312	20000	10000	17500	20000	15000	11500	17500	8000	13000
	10-9M12	3/4 x 0.516	15000	7000	13000	15000	10000	8000	14000	6000	9500
	20-9M12	3/4 x 0.438	20000	10000	17500	20000	15000	11500	17500	8000	13000
	10-9M16	1 x 0.688	15000	7000	13000	15000	10000	8000	14500	6000	9500
	20-9M16	1 x 0.562	20000	10000	17500	20000	15000	11500	17500	8000	13000
High Pressure	60-9H2	1/8 x 0.020	60000	30000	40000	60000	30000	23000	40000	17500	28000
	30-9H2	1/8 x 0.040	30000	20000	30000	30000	25000	17500	30000	13000	21000
	60-9H4	1/4 x 0.083	60000	30000	40000	57000	30000	23000	40000	17500	28000
	60-9H6	3/8 x 0.125	60000	30000	40000	57000	30000	23000	40000	17500	28000
	60-9H9	9/16 x 0.188	60000	30000	40000	57000	30000	23000	40000	17500	28000
	40-9H9	9/16 x 0.250	40000	20000	34000	40000	23000	17500	30000	13000	21000
	30-9H16	1 x 0.437	43000	20000	35000	43000	23000	17500	30000	13000	21000

\* Not all tubing sizes available in all materials.

## Temperature Rating

Taper Seal Series Valves and Fittings

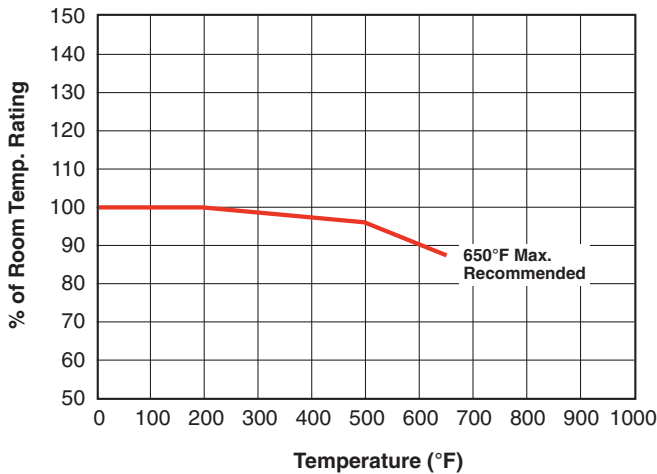

## Pressure Rating Reduction

316 and 304 SS Components at Elevated Temperatures

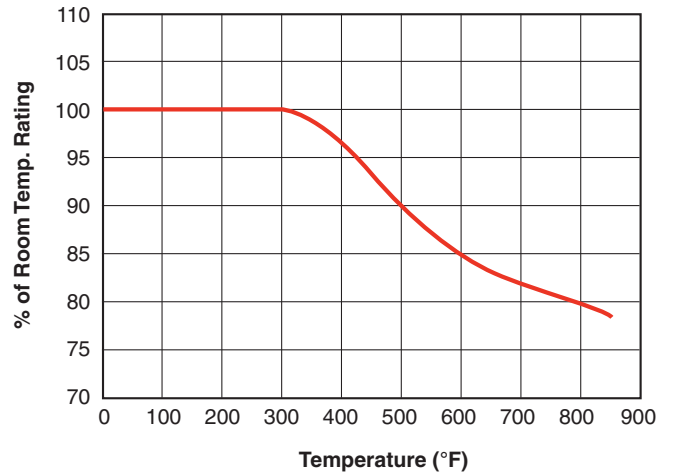

---

## **Warranty**

*High Pressure Equipment Company warrants the products which it manufactures to be free from defects in material and workmanship which would impair their intended usefulness. This warranty is for a period of one year after the date of shipment. Warranty is limited to the repair or replacement of any item manufactured by High Pressure Equipment Company. High Pressure Equipment Company shall not be liable for any direct or indirect consequential damage arising from a failure or malfunction of the equipment. This warranty further excludes damage, failure or malfunction which is caused by corrosion or erosion common to the material supplied.*

*Terms: Net 30 for qualified accounts*

*FOB: Erie, PA - USA*



**65 YEARS**

**4 million  
valves & fittings later...**

**There's still only  
ONE High Pressure!**



High pressure valves, fittings and tubing manufactured to the highest quality standards, delivered with the shortest lead times, and priced to save you money... it's been the focus at HiP throughout our 65 year history. This unwavering commitment to our loyal customers is the driving force behind our ongoing growth, most recently demonstrated by our passing the 4 million high pressure valves and fittings shipped milestone!

Today, we feature a broad product portfolio capable of handling pressures up to 150,000 psi and carry an extensive inventory allowing us to offer same day shipping of many items. And if you have special requirements, such as exotic alloys and custom manifolds, our technical/engineering team will help you find the ideal solution.

Find out how we can help with your waterjet cutting and blasting system, give us a call at 800-289-7447 or visit us online [www.HighPressure.com](http://www.HighPressure.com).

ISO 9001  
CERTIFIED

**High Pressure  
Equipment  
Company**



**HiP...Our Name is High Pressure**



# High Pressure Equipment

A **GRACO** Company

2955 W. 17th Street  
Erie, Pennsylvania 16505 U.S.A.  
Phone: (814) 838-2028 • 1-800-289-7447  
Fax: (814) 838-6075  
E-Mail: [sales@highpressure.com](mailto:sales@highpressure.com)  
[www.HighPressure.com](http://www.HighPressure.com)