

ФИТИНГИ ЗАЖИМНЫЕ СВЕРХ ВЫСОКОГО ДАВЛЕНИЯ

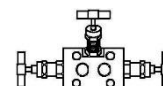

Серия 15N – 15 000 psi (1034 атм)

Серия 20N – 20 000 psi (1379 атм)

Серия 60N – 60 000 psi (4137 атм)

Производство Китай

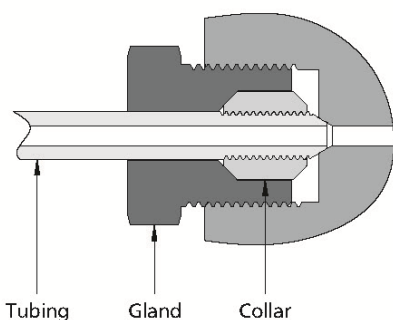

Конфигурации:

Glands - G



3

Collars - CO



3

Plugs - TP



3

Reducing Union Couplings - U

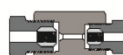

4

Union Couplings (Slip Type) - SU



4

Bulkhead Couplings - BU

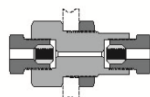

5

Caps - TC



5

Elbows - LU

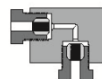

5

Tees - TTT

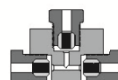

6

Crosses - C

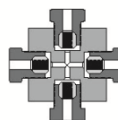

6

Anti-Vibration Gland Assemblies - AVGA

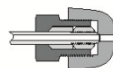

7

Coned and Threaded Nipples - CTN



7